

# LUCAS

SECTION

G

## HEADLAMPS

### EXTERNAL AND FLUSH FITTING

#### Model Interpretation

##### PREFIX

B .. ..	Brass (chromium plated) body.
D .. ..	Domed lens.
F .. ..	Flush fitting.
J .. ..	Jaguar.
L-H1-O ..	Lucas headlamp; double contact; 5" aperture.
L-H2-O ..	Lucas headlamp; single contact; 5" aperture.
L .. ..	Used on models normally fitted with separate reflector and lens to denote light unit.
M .. ..	Standard lamp with separate reflector and lens. Reflector held with rubber bead.
P .. ..	Projector.
R .. ..	Rolls-Royce.
S .. ..	Spigot fixing (S700 only).
SS .. ..	Side socket fixing.
U .. ..	Switch panel fitted in headlamp body.

##### SUFFIX

42 .. ..	6" aperture.
80 .. ..	8 $\frac{3}{4}$ " aperture; 7 $\frac{7}{8}$ " depth.
100 .. ..	10 $\frac{1}{4}$ " aperture; 8" depth.
133 .. ..	6" aperture; 7" depth, excluding lens.
134 .. ..	6" aperture; 8" depth, excluding lens.
140 .. ..	7 $\frac{1}{2}$ " aperture; 6" depth, excluding lens.
141 .. ..	7 $\frac{1}{2}$ " aperture; 8 $\frac{1}{2}$ " depth, excluding lens.
143 .. ..	7 $\frac{1}{2}$ " aperture; 6" depth, excluding lens.
147 .. ..	7 $\frac{1}{2}$ " aperture; 7 $\frac{1}{2}$ " depth, excluding lens.
148 .. ..	7 $\frac{1}{2}$ " aperture; 7 $\frac{1}{2}$ " depth, excluding lens.
163 .. ..	8 $\frac{1}{2}$ " aperture; 8 $\frac{7}{16}$ " depth, excluding lens. As 166 except for method of fixing.
166 .. ..	8 $\frac{1}{2}$ " aperture; 8 $\frac{7}{16}$ " depth, excluding lens. As 163 except for method of fixing.
575 .. ..	5 $\frac{3}{4}$ " aperture.
575-1 ..	5 $\frac{3}{4}$ " aperture; special for Morris Motors.
700 .. ..	7" aperture.
770 .. ..	7.70" aperture.
EF .. ..	Export France.
EDS .. ..	Electric dip and switch.
LR .. ..	Special long range light unit.
P .. ..	Pilot light.

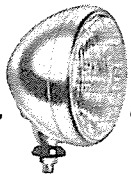

# HEADLAMPS, External Fitting

## INDEX

Part No.	Model	Page	Part No.	Model	Page	Part No.	Model	Page
50079B	MBD133	G10	50217A	MD141-EDS	G16	50344A	MB150-EDS	G20
50081B	MBD133-EDS	G12	50218A	MD141	G14	50345A	MB150	G20
50082B	MBD133	G10	50219A/F	MD134-1	G12	50349B	MBD166S	G22
50083B	MBD133-EDS	G12	50220D	MD134-1	G12	50364B	MD133P	G11
50086D	MBD134-1	G12	50221D	MD134-1	G12	50370A	L133P-3	G11
50087D	MBD134-EDS	G12	50222D	MD134-1	G12	50379A	MBD141	G15
50088A	FF133-1P	G11	50223D	MBD134-1	G12	50380A	MBD141	G15
50089A	FF133-EDS	G10	50224A/D	MBD134-1	G12	50383B	MBD148S	G20
50095A	MBD147-EDS	G19	50227A	MD141	G14	50384B	MBD148S	G20
50096A	MBD147	G18	50228A	MD141	G14	50385B	MBD166S	G22
50098A	MBD148	G20	50231A	MBD141	G14	50402A	MD143-EDS	G17
50102A	MBD140	G14	50232A	MBD141	G14	50403A	MD143	G16
50103A	MBD140-EDS	G13	50233A	MD145-EDS	G18	50406D	MD133	G10
50107A	MBD143-EDS	G17	50234A	MD145	G18	50413D	MD133-3EDS	G12
50108A	MBD143	G16	50235A	MD145	G18	50414D	MBD133P	G10
50124B	L-H1-O	G10	50236A	MD145	G18	50415D	MBD133P	G10
50129A	L-H2-O	G10	50237A	MD145	G18	50426A	FF133-1P	G11
50141A	L133-EDS	G12	50238A	MD145	G18	50427A	MD140	G15
50142A	L133	G10	50245A	MD140	G14	50431A	M147P-EDS	G19
50146D	MBD133-EDS	G12	50250A	LBD133-1EDS	G12	50432A	M147P	G19
50147B/D	MBD133-1	G10	50251A	MBD133	G11	50433A	MD148P-EDS	G20
50148D	MBD133-1	G10	50253B	MBD140-EDS	G13	50434A	MD148P	G21
50149D	MBD133-1	G10	50254B	MBD140	G14	50439A	MD140	G15
50150D	MBD166S-EDS	G21	50260D	MD133-1EDS	G12	50440A	MD140-EDS	G13
50151B	MBD166S	G22	50261D	MD133-1	G11	50441A	MD140	G15
50153A	MD140-1EDS	G13	50267D	MBD133-2	G11	50442A	MD140-EDS	G13
50154A	MD140-1	G14	50268D	MBD133-2	G11	50443A	MD140	G15
50155A	MBD147-EDS	G19	50273A/D	MBD166-1S	G22	50452A	MD140-EDS	G13
50156A	MBD147-3	G18	50274A	MBD147-1	G18	50453A	MD140	G15
50170D	MBD133-2	G10	50284A	MBD150	G20	50454A	MD140-EDS	G13
50171D	MBD133-EDS	G12	50285A	L-H1-O	G10	50455A	MD140	G15
50174A	MBD147-EDS	G19	50289D	MBD166S-EDS	G21	50458A	MBD140	G15
50175A	MBD147-4	G18	50291A	MBD140	G14	50459A	MBD140	G15
50176A	MBD147-1EDS	G19	50292D	M42	G11	50460D	MD140-EDS	G13
50177A	MBD147-1	G18	50300B	MBD143	G16	50461D	MD140-1	G15
50178A	LBD166	G22	50301B	MBD143	G16	50464A	MD140	G15
50181A	MBD166S-EDS	G21	50303A	L133	G11	50465A	MD140	G14
50182A	MBD166	G22	50304A	MBD147-3	G19	50472A	MBD148-EDS	G20
50185H	MU42	G29	50305A	MBD147-3	G19	50473A	MBD148	G21
50194A	MD145-EDS	G18	50306D	M42	G11	50474A	MBD148-EDS	G20
50195A	MD145	G18	50314B	MBD148S	G20	50475A	MBD148	G21
50196A	MBD141-EDS	G16	50315B	MBD148S	G20	50476A	MBD148	G21
50197A	MBD141	G14	50316A	MBD150S	G20	50478A	MD140-EDS	G13
50199D	MD134-EDS	G12	50317A	MBD150S	G20	50481A	MBD140-EDS	G13
50200D	MD134-1	G12	50319B	MD133P	G11	50482A	MBD140	G14
50201A	L133P	G11	50323A	MBD140	G14	50483A	MBD140	G14
50202A	L133P	G11	50324A	MBD140DP	G13	50490A	MBD140	G14
50203A/D	MBD166-1S	G22	50325B	MBD166S-EDS	G21	50491A	MBD140	G14
50204A	M140-EDS	G13	50326B	MBD166S	G22	50500A	MBD147-EDS	G19
50205A	M140	G14	50330D	MBD166S-EDS	G21	50507A	MBD147-4	G19
50210A	MBD148	G20	50331D	MBD166S	G22	50508A	MBD147-4	G19
50211A	MBD148	G20	50336A	M150-EDS	G20	50511A	MD140-EDS	G13
50213A	MBD148-EDS	G20	50337A	M150	G20	50512A	MD140	G14
50215D	MD134-1EDS	G12	50338A	M150	G20	50515A	MD140-1EDS	G13
50216D	MD134-1	G12	50339A	M150	G20	50516A	MD140	G14
						50519A	MD140	G15

# HEADLAMPS, External Fitting



## INDEX

Part No.	Model	Page	Part No.	Model	Page	Part No.	Model	Page
50523A	MBD140	G15	50659B	MD133-1	G11	50896B	S700	G22
50526D	MD133P	G10	50672A	MD143-EF	G17	50897B	S700	G22
50527D	MD133P	G10	50673A	MD143-EF	G17	50914B	S700	G22
50530B	MBD166-2S	G23	50706A	MU42	G29	50915B	S700	G23
50531B	MBD166-2S	G23	50707A	MBD143-EDS	G17	50929A	MD133P	G11
50540B	MBD163-1EDS	G21	50708A	MBD143	G17	50947A	SS700P	G23
50541B	MBD163-1	G21	50709A	MBD143	G16	50950A	M42	G11
50542B	MBD163-1	G21	50710A	MBD143	G16	50985A	S700	G23
50543B	MBD163-1	G21	50711A	MD143-EDS	G17	50986A	S700	G23
50549A	L133P-3	G10	50712A	MD143	G16	50987A	S700-EF	G23
50554B	MBD166S	G23	50713A	MD143	G16	50988A	S700	G23
50555A	MD141-EDS	G16	50714A	MD143	G16	50989A	S700	G23
50556A	MD141	G15	50716D	MBD140-EDS	G13	50990A	S700	G23
50557A	MD141-EDS	G16	50717D	MBD140	G15	50991A	S700-EF	G23
50558A	MD141	G15	50718F	MBD140	G15	50995A	S700	G24
50561A	MD141E	G15	50719A	MBD141-EDS	G16	50996A	S700	G24
50562A	MD141E	G15	50720A	MBD141	G15	51014A/F	S700	G24
50565A	MBD141E	G15	50728D	S700	G22	51015A/F	S700	G24
50566A	MBD141E	G15	A50728D	S700	G22	51016A/F	S700	G24
50569B	MD133P	G10	B50728D	S700	G22	51017A	S700	G24
50570B	MD133P	G10	50729D	S700	G22	51018A	S700	G24
50580B	MBD166	G23	50730A	L-H-O	G10	51023E	S700	G24
50581B	MBD166	G23	50741A	MBD148S	G21	51024E	S700	G24
50583A	MD140-EDS	G13	50742A	MBD148S	G21	51025F	S700	G24
50584A	MD140-1	G15	50743A	MBD148S	G21	51026A	S700	G24
50585A	MD140-1	G15	50746B	MD133P	G11	51027A	S700	G24
50588A/D	MBD143-EDS	G17	50752A	MBD140-EDS	G13	51029A	S700	G24
50589A/D	MD143	G16	50753A	MBD140	G15	51076A	SS575	G24
50591A	MBD143-EDS	G17	50775E	S700	G22	51078E	S700	G24
50592A	MBD143	G17	50798D	S700	G22	51079E	S700	G24
50593A	MBD143	G17	50821D	S700	G22	51080E	S700	G24
50594A	MBD143	G17	A50821D	S700	G22	51138A	MD134-1	G12
50595A	MBD140-EDS	G13	B50821D	S700	G23	51139A	MD134-1	G12
50596A	MBD140-EDS	G13	50854D	S700	G23	51140A	MD134-1	G12
50600B	MBD166S-EDS	G21	A50854D	S700	G23	51331A	MBPL147	G19
50601B	MBD166S	G23	B50854D	S700	G23	51353A	S700	G24
50602A	MD143	G17	50855B	S700	G23	51354A	S700	G24
50603A	MD143	G17	50861A	MBD166-EDS	G21	51355A	S700	G24
50606B	M140	G15	50862A	MBD166S	G23	51405A	S700	G24
50607B	M140	G15	50869D	S700	G23	51473A	MBL140	G15
50623A	MBD148	G21	A50869D	S700	G23	51644A/D	ML143	G17
50624A	MBD147-EDS	G19	B50869D	S700	G23	51645A/D	ML143	G17
50625A	MBD147-3	G19	50870D	S700	G23	51651A	S700EF	G24
50632D	MD133P-3	G11	50873A/B	S700	G23	51671A	ML143	G17
50633D	MD133P-3	G11	50876B	S700-EF	G22	51673A	ML143	G17
50634A	MBD147-3	G19	50877B	S700	G22	51674A	ML143	G17
50635A	MBD147-3	G19	50892A	MBPL147	G19	51675A	ML143-EF	G17
50645A/D	MBD133P	G11	A50892A	MBPL147	G19	51676A	ML143-EF	G17
50646A/D	MBD133P	G11	B50892A	MBPL147	G19	51677A/B	ML143	G17
50647B	MBD133P	G11	50893A	MBPL147	G19	51678A/B	ML143	G17
50648B	MBD133P	G11	50894A	MBPL147	G19	51682A	S700	G24
50649A/B	MD133P-3	G11	A50894A	MBPL147	G19	51906A	SS700	G24
50654A	MBD148	G21	B50894A	MBPL147	G19	58295A	S700	G24
50655A	MBD166S	G23	50895B	S700	G22	58464A	S700	G24
50656A	MBD166	G23	A50895B	S700	G22	506096	LBD166-2EDS	G21
50657A	MBD166S	G23	B50895B	S700	G22	506097	LBD166S	G23

## MODELS P80, P100 AND R100

### DETAILED SPARE PARTS

Part No. . . . .	‡50161A	‡50162A	50163B	50164B	50307A/B	50329A	‡50355A	50428A	50489B
Model . . . . .	P80-2EDS	P80-2	P100LS-EDS	P100LS	P100LS-EDS	R100S	P80-2	R100S	P100L
Finish . . . . .	Chromium	Chromium	Chromium	Chromium	Chromium	Chromium	Chromium	Chromium	Chromium
§Rim or door . . . . .	551604	551604	506587	506587	506587	506587	551604	506587	506587
Pin, joint, with cap . . . . .	—	—	—	—	—	—	—	—	—
§ Wires, lens fixing . . . . .	551603	—	506500	506500	506500	506500	551603	506500	506500
§ Bead, rubber . . . . .	506502	506502	506502	506502	506502	506502	506502	506502	506502
§Lens or glass . . . . .	500371	500371	509689	509689	509689	506411	500371	506411	509689
Motif, with fixing screws . . . . .	—	—	506589	506589	506589	506588	—	506588	506589
§Dipper unit, with fixing screws . . . . .	57017	—	509610	—	509610	—	—	—	—
§Fuse . . . . .	188232	—	188236	—	188236	—	—	—	—
Clip and screw, bulb holder fixing . . . . .	551807	551807	510049	510049	510049	510049	551807	510049	551807
Screw . . . . .	132544	132544	132544	132544	132544	132544	132544	132544	132544
§Bulb holder or adaptor . . . . .	504804	504804	509684	509684	509684	509684	504801	507701	504801
§Backshell . . . . .	—	—	509607	509607	509639	509607	—	509607	509678
Backshell, with bulb holder . . . . .	—	—	—	—	—	—	—	—	—
§Reflector or light unit . . . . .	—	—	506595	506595	509648	506594	—	506594	506595
Spring and cover . . . . .	—	—	506593	506593	506593	506593	—	506593	506593
Clip, reflector securing . . . . .	551671	—	—	—	—	—	—	—	—
Ball, reflector securing . . . . .	510109	—	—	—	—	—	—	—	—
Spring, backshell securing . . . . .	551669	—	511658	511658	511658	511658	—	511658	511658
Spring, reflector return . . . . .	—	—	506504	506504	506504	506504	—	506504	506504
§Bulb . . . . .	57	57	87	87	87	87	171	182	—
Bracket, bulb shield . . . . .	—	—	—	—	—	506457	—	506457	—
Medallion, with nut and washer . . . . .	—	—	—	—	—	506591	—	506591	—
Button, centre . . . . .	—	—	505310	505310	505310	—	—	—	505310
Shield, bulb . . . . .	—	—	509669	509669	509669	—	—	—	509669
Tripod . . . . .	—	—	506506	506506	506506	—	—	—	506506
§Wires, light unit fixing . . . . .	—	—	—	—	—	—	—	—	—
§Rim, unit . . . . .	—	—	—	—	—	—	—	—	—
§Rim, extension . . . . .	—	—	506598	506598	509649	506597	—	506597	506598
§Buffer, rubber . . . . .	—	—	506473	506473	506473	506473	—	506473	506473
§Junction box . . . . .	—	—	501398	501398	501398	501398	—	501398	501398
Base . . . . .	—	—	506585	506585	506585	506585	—	506585	506585
Screw, base fixing . . . . .	—	—	118540	118540	118540	118540	—	118540	118540
§Nut, lamp fixing . . . . .	170288	170288	170288	170288	170288	500357	—	500357	170288
Washer, lamp fixing . . . . .	—	—	188349	188349	188349	188349	—	188349	188349
Screw, rim locking . . . . .	500362	500362	122431	122431	122431	122431	500362	122431	122431
Motif, body . . . . .	—	—	506582	506582	506582	506582	—	506582	506582
§Bead, rubber . . . . .	—	—	506503	506503	506503	506503	—	506503	506503
§Sundry parts, set . . . . .	—	—	553652	553652	553652	553652	—	553652	553652

‡ Complete lamp no longer available, return old unit for repair

§ Recommended spares for stock

For illustrations, see page G6

continued

**MODELS P80, P100 AND R100**  
**DETAILED SPARE PARTS**

Part No. . . . .	50502A	50532A	50533A	50628A	50693A	50731A	50773B	50816B	50820A
Model . . . . .	P100LS-EDS	P100LS-EDS	P100LS	P100LS	R100S-EF	R100S-EDS	P100	R100	R100L-EF
Finish . . . . .	Chromium	Chromium	Chromium	Chromium	Chromium	Chromium	Chromium	Chromium	Chromium
§Rim or door . . . . .	506587	506587	506587	506587	506587	506587	506587	506587	506587
Pin, joint, with cap . . . . .	—	—	—	—	—	—	—	—	—
§ Wires, lens fixing . . . . .	506500	506500	506500	506500	506500	506500	506500	506500	506500
§ Bead, rubber . . . . .	506502	506502	506502	506502	506502	506502	506502	506502	506502
§Lens or glass . . . . .	506508	509689	509689	509689	506411	506411	506411	506411	506508
Motif, with fixing screws . . . . .	506589	506589	506589	506589	506588	506588	506589	506588	506589
§Dipper unit, with fixing screws . . . . .	509610	509610	—	—	—	509610	—	—	—
§Fuse . . . . .	188236	188236	—	—	—	188236	—	—	—
Clip and screw, bulb holder fixing . . . . .	510049	510049	510049	510049	—	510049	—	—	—
Screw . . . . .	132544	132544	132544	132544	—	132544	—	—	—
§Bulb holder or adaptor . . . . .	509684	509684	509684	507701	562303	509684	860895	—	562303
§Backshell . . . . .	509607	509607	509607	509607	—	509607	—	—	—
Backshell, with bulb holder . . . . .	—	—	—	—	506481	—	—	—	506481
§Reflector or light unit . . . . .	506595	506595	506595	506595	509623	506594	506595	506595	553674
Spring and cover . . . . .	506593	506593	506593	506593	506593	506593	506593	506593	506593
Clip, reflector securing . . . . .	—	—	—	—	—	—	—	—	—
Ball, reflector securing . . . . .	—	—	—	—	—	—	—	—	—
Spring, backshell securing . . . . .	511658	511658	511658	511658	511658	511658	511658	511658	511658
Spring, reflector return . . . . .	506504	506504	506504	506504	506504	506504	506504	506504	506054
§Bulb . . . . .	96	96	96	182	—	96	303	—	—
Bracket, bulb shield . . . . .	—	—	—	—	506457	506457	—	—	—
Medallion, with nut and washer . . . . .	—	—	—	—	506591	506591	—	—	—
Button, centre . . . . .	505310	505310	505310	505310	—	—	—	—	505310
Shield, bulb . . . . .	509669	509669	509669	509669	—	—	—	—	509669
Tripod . . . . .	506506	506506	506506	506506	—	—	—	—	506506
§Wires, light unit fixing . . . . .	—	—	—	—	—	—	504665	504665	—
§Rim, unit . . . . .	—	—	—	—	—	—	553642	553642	—
§Rim, extension . . . . .	506598	506598	506598	506598	506597	506597	553664	553664	506598
§Buffer, rubber . . . . .	506473	506473	506473	506473	506473	506473	506473	506473	506473
§Junction box . . . . .	501398	501398	501398	501398	501398	501398	501398	501398	501398
Base . . . . .	506585	506585	506585	506585	506585	506585	506585	506585	506585
Screw, base fixing . . . . .	118540	118540	118540	118540	118540	118540	118540	118540	118540
§Nut, lamp fixing . . . . .	500357	500357	500357	500357	500357	500357	500357	500357	500357
Washer, lamp fixing . . . . .	188349	188349	188349	188349	188349	188349	188349	188349	188349
Screw, rim locking . . . . .	122431	122431	122431	122431	122431	122431	122431	122431	122431
Motif, body . . . . .	506582	506582	506582	506582	506582	506582	506582	506582	506582
§Bead, rubber . . . . .	506503	506503	506503	506503	506503	506503	506503	506503	506503
§Sundry parts, set . . . . .	553652	553652	553652	553652	553652	553652	553652	553652	553652

**HIGH POWER PROJECTORS**

50502 — 50820



# HIGH POWER PROJECTORS

MODELS P80, P100 AND R100

**RIM OR DOOR**

506587

551604

**REFLECTOR**

505332

506597 (Special for Rolls Royce)  
506598 (Non-Dip)  
509649 (Vertical Dip)  
553664 (Special piercing)

**RIM, EXTENSION**

553642

506503

**BEADS (Rubber)**

506502

509653

**TRIPODS**

505309

Button 505310 (Black)

506506

506594 (Facetted)  
506595 (Plain)  
509623 (Facetted-Export France)  
509648 (Plain-Vertical Dip)  
553674 (Plain-Export France)

**DIPPER UNIT**

57017  
509610 (Insul. Return)

504801

504804

**BULBHOLDERS**

507701

509684

562303

860895

Backshell and Bulbholder (Typical)

**MOTIF**

506582

**WIRES Fixing**

504665

506593

506500 (P100 Type)  
551603 (P80 Type)

**SUNDRY PARTS SET**

553652

**JUNCTION BOX**

501398

Screw 122431

Bulbshield 509669

Base 506585

**MODELS P100 R100**

For illustrations and details of headlamp lenses, see pages G4 and G5

# HEADLAMPS, External Fitting



**RIM OR DOOR ASSEMBLIES**

Prism 509754

507577

509744

534343

553435

551361  
551075 (Chrome)  
508718 (Chrome)

Rim, Extension

506860

553248

553080  
509484 (Chrome)

552261

508248

**BRACKETS, ACTION**

508595

509740

509739

**REFLECTORS**

501875

508247  
509745 (with pilot)  
508596 (Single Contact)

509793

553145 (Single Contact)  
553148 (Double Contact)

506854 (Single Contact)  
506855 (Double Contact)  
551912 (Double Contact with pilot)

508755 (9 1/8" Dia.)  
507002 (8 5/8" Dia.)  
509746 (6" Dia.)  
508278 (For 3 pin Adaptor)

553147 (Double Contact main)  
(Single Contact pilot)

553146 (Single Contact main and pilot)

553159

551966 (Double Contact)  
551998 (Single Contact)

553759

555447

553921  
516798 (with pilot)  
553695 (SS575 Type)  
553925 (Vertical dip)

553940  
553948 (Silvered Reflector)  
555275 (with pilot)  
54520148 (for 3 pin adaptor)

553961

For illustrations and details of headlamp lenses, see pages G69 and G70



# HEADLAMPS, External Fitting

## FIXING WIRES

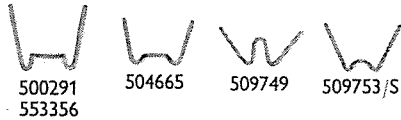

500291  
553356

504665

509749

509753/S

## CATCH ASSEMBLIES

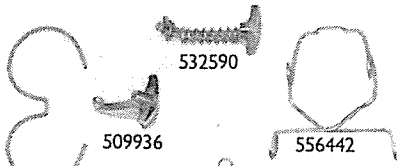

509936

532590

556442

Spring  
509191

500186  
551669

Sleeve  
188818



500181



504804



504801

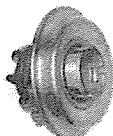

552943



553738

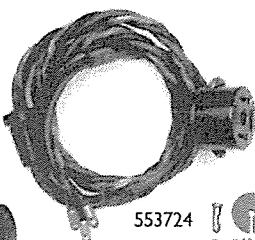

553724

Sleeve  
555910

554602 (Double Contact)  
554607 (Single Contact)

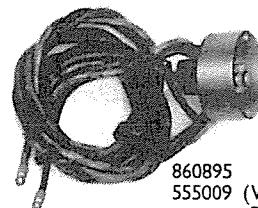

860895  
555009 (With Pilot)



553780



554710



554354



562303

## BULBHOLDERS, INTERIORS AND ADAPTORS

Screw  
186130

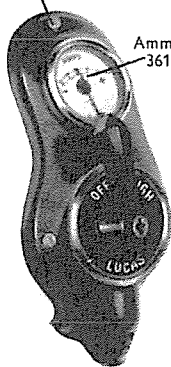

Ammeter  
36184

516387

365227

523986

Roller 351660

Plunger 351661

Spring 351662

57016 (6v)  
57017 (12v)

503014 (4.3/8" long)

504177 (2" long)

503970

505525

505626

508736

351501

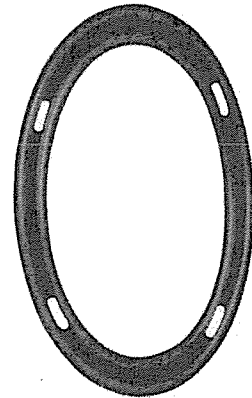

509724

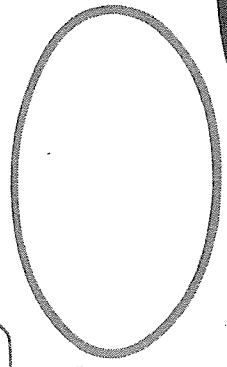

506361

507088 (9" dia)  
507154 (9 3/8" dia)  
509201 (8 3/8" dia)  
553065 (7" dia)

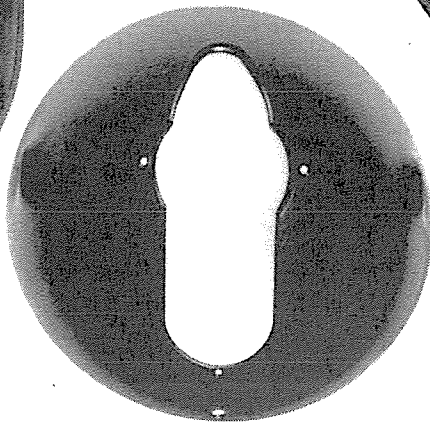

516293

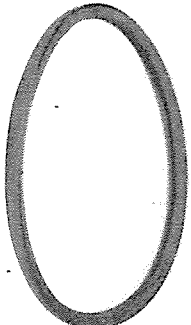

551959

For illustrations and details of headlamp lenses, see pages G69 and G70



# HEADLAMPS (with Switch Panels), External Fitting



## DETAILED SPARE PARTS

Part No... .. .	50185H MU42 Black, C.P.R. —	†50706A MU42 Black, C.P.R. (50185)
Model .. .. .		
Finish .. .. .		
Replaced by (see footnote) .. .. .		
§Instrument panel, complete .. .. .	516387	516387
Screw, panel fixing .. .. .	186130	186130
§ Ammeter .. .. .	36184	36184
§ Ring, rubber .. .. .	523986	523986
§ Nut, terminal .. .. .	166043	166043
§ Washer, spring, terminal .. .. .	185022	185022
Warning light .. .. .	365227	365227
§ Bulb .. .. .	998	998
§ Switch, lighting .. .. .	34080	34080
§ Key .. .. .	344715	344715
§ Handle, with fixing screws .. .. .	‡344729	344729
Screw, fixing .. .. .	—	—
Shaft, headpiece .. .. .	—	—
Roller, contact .. .. .	—	—
Plunger, contact .. .. .	—	—
Spring, contact plunger .. .. .	—	—
Screw, terminal .. .. .	120560	120560
Spring, switch fixing .. .. .	—	—
§ Ring, rubber, fixing .. .. .	523986	523986
Screw, cable clip .. .. .	186128	113100
Washer, cable clip .. .. .	188453	—
§Rim or door .. .. .	509484	509484
§ Wire, fixing .. .. .	509753/S	509753/S
§ Lens .. .. .	550875	550875
§Screw or catch, rim fixing .. .. .	509936	509936
Spring, rim catch .. .. .	509191	509191
§Bead, rubber, reflector .. .. .	553065	553065
Plate, rim fixing .. .. .	—	—
§Light unit or reflector .. .. .	553147	553147
§Bulb holder .. .. .	504801	504801
§ Sleeve, terminal .. .. .	188818	188818
Clip and screw .. .. .	551807	551807
§Bulb holder or plate, pilot .. .. .	—	—
§ Interior, pilot .. .. .	500181	500181
§Bead, pilot bulb holder .. .. .	—	—
Grommet, cable entry .. .. .	—	—
Washer, cable grip, pilot .. .. .	516285	—
§Screw, lamp fixing .. .. .	112201	112201
Washer, lamp fixing screw .. .. .	137141	137141
Body .. .. .	516293	—
§Bulb, main .. .. .	168	168
§Bulb, pilot .. .. .	200	200

For illustrations, see pages G7–G8

Note. For replacement spare parts, see appropriate column under part number    † When ordering, quote part number shown in brackets  
 ‡ Cover, ignition    § Recommended spares for stock    C.P.R. .. Chromium plated rim

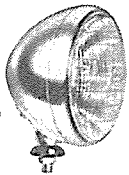

# HEADLAMPS, External Fitting

## DETAILED SPARE PARTS

### LH Dipping (Double Filament) and Non-dip Models

Part No. . . . .	50124B L-H1-O	50129A L-H2-O	†50285A L-H1-O	50730A L-H-O
Model . . . . .	Black	Black	Black	Black
Finish . . . . .	Black	Black	Black	Black
Replaced by (see footnote) . . . . .	—	—	(50124)	—
§Rim or door . . . . .	552261	552261	552261	552261
§ Glass . . . . .	552282	552282	552282	552282
§ Wires, glass fixing . . . . .	504665	504665	504665	504665
§Bead, rubber . . . . .	551959	551959	551959	551959
§Reflector . . . . .	551966	551998	551966	551966
§ Bulb holder . . . . .	504801	504804	504801	504801
§ Sleeve, terminal . . . . .	555910	555910	555910	555910
Clip and screw, bulb holder clamping . . . . .	551807	551807	551807	551807
§Bulb, main, 12 volt . . . . .	171	57	171	5
§Bulb, main, 6 volt . . . . .	109	106	—	—
Nut, fixing bolt . . . . .	180377	180377	180377	180377
Washer, fixing bolt . . . . .	188349	188349	188349	188349
§Screw, rim fixing . . . . .	552255	552255	552255	552255
§Bolt, lamp fixing . . . . .	503014	503014	503014	503014

### FF133-EDS Dipping Reflector Model

Part No. . . . .	*50089A FF133-EDS
Model . . . . .	C.P.R.
Finish . . . . .	C.P.R.
§Rim or door . . . . .	509744
§ Glass . . . . .	509757
§ Wires, lens fixing . . . . .	509753/S
§Bead, rubber . . . . .	†509724
	506361
§Reflector . . . . .	509745
§ Bulb holder, interior, main . . . . .	500181
§ Sleeve, terminal . . . . .	555910
§ Bulb holder, interior, pilot . . . . .	500181
§Bulb, main, 6 volt . . . . .	106
§Bulb, pilot, 6 volt . . . . .	200
§Dipper unit . . . . .	57016
§ Fuse . . . . .	188235
Bracket, action . . . . .	509739
Screw, rim catch . . . . .	113531
Prism . . . . .	509754
Wires, prism fixing . . . . .	509749

### LBD and MBD133 Dipping (Double Filament) and Non-dip Models

Part No. . . . .	50079B MBD133	50082B MBD133	†50142A L133	50147B MBD133-1	50147D MBD133-1	50148D MBD133-1	†50149D MBD133-1	50170D MBD133-2
Model . . . . .	Chromium	Chromium	Black	Chromium	Chromium	Chromium	Chromium	Chromium
Finish . . . . .	Chromium	Chromium	Black	Chromium	Chromium	Chromium	Chromium	Chromium
Replaced by (see footnote) . . . . .	—	—	(50079)	—	—	—	(50147)	—
(1) §Rim or door . . . . .	509484	509484	553080	509484	509484	509484	509484	509484
(2) § Glass . . . . .	550875	550875	516144	550875	550875	550875	550875	550875
(3) § Wires, glass fixing . . . . .	509753/S	509753/S	500291	509753/S	509753/S	509753/S	509753/S	509753/S
(4) §Bead, rubber . . . . .	553065	553065	506361	553065	553065	553065	553065	553065
(5) §Reflector . . . . .	553145	553145	*508571	553145	553145	553148	553148	553145
(6) § Bulb holder or interior . . . . .	500181	500181	500181	500181	504801	504801	504801	500181
(7) § Interior, pilot . . . . .	—	—	—	—	—	—	—	—
(8) §Sleeve, terminal . . . . .	—	555910	—	555910	555910	555910	555910	555910
(9) §Bulb, 12 volt . . . . .	57	—	57	—	—	—	—	—
(10) §Bulb, 6 volt . . . . .	106	106	106	106	168	168	168	106
(11) Nut, fixing bolt . . . . .	183940	183940	181261	170290	170290	170290	170290	180377
(12) Washer, fixing bolt . . . . .	188350	188350	188350	188350	188350	188350	188350	188349
(13) §Bolt, lamp fixing . . . . .	505626	505626	505626	505626	505626	505626	505626	503970
(14) §Catch or screw, rim fixing . . . . .	509936	509936	552255	509936	509936	509936	509936	509936
(15) Spring, rim catch . . . . .	509191	509191	—	509191	509191	509191	509191	509191

### LBD and MBD133—continued

Part No. . . . .	†50406D MD133	50414D MBD133P	50415D MBD133P	†50526D MD133P	†50527D MD133P	†50549A L133P-3	50569B MD133P	†50570B MD133P
Model . . . . .	Black	Chromium	Chromium	Black	Black	Black	Black	Black
Finish . . . . .	Black	Chromium	Chromium	Black	Black	Black	Black	Black
Replaced by (see footnote) . . . . .	—	—	—	(50364)	(50364)	(50746)	—	(50319)
(1) §Rim or door . . . . .	553080	509484	509484	553080	553080	553080	553080	553080
(2) § Glass . . . . .	550875	503403	503403	550875	550875	516199	550875	550875
(3) § Wires, glass fixing . . . . .	509753/S	500291	500291	509753/S	509753/S	500291	509753/S	509753/S
(4) §Bead, rubber . . . . .	553065	553065	553065	553065	553065	506361	553065	553065
(5) §Reflector . . . . .	553148	553147	553147	553147	553147	—	553147	553146
(6) § Bulb holder or interior . . . . .	504801	504801	504801	504801	504801	500181	504801	504804
(7) § Interior, pilot . . . . .	—	500181	500181	500181	500181	—	500181	500181
(8) §Sleeve, terminal . . . . .	555910	555910	555910	555910	555910	555910	555910	555910
(9) §Bulb, 12 volt . . . . .	—	—	—	—	—	—	171 #207	57 #207
(10) §Bulb, 6 volt . . . . .	168	168 #200	168 #200	168 #200	168 #200	106 #200	—	—
(11) Nut, fixing bolt . . . . .	183940	183940	183940	183940	183940	180377	183940	183940
(12) Washer, fixing bolt . . . . .	188350	188350	188350	188350	188350	188349	188350	188350
(13) §Bolt, lamp fixing . . . . .	505626	505626	505626	505626	505626	505626	505626	505626
(14) §Catch or screw, rim fixing . . . . .	509936	509936	509936	509936	509936	552255	509936	509936
(15) Spring, rim catch . . . . .	509191	509191	509191	509191	509191	—	509191	509191

For illustrations, see pages G7-G8

Note. For replacement lamp spare parts, see appropriate column under part number \* See Supersession Chart  
 † When ordering, quote part number shown in brackets ‡ Body fixing § Recommended spares for stock ¶ Pilot C.P.R. . . Chromium plated rim

# HEADLAMPS, External Fitting

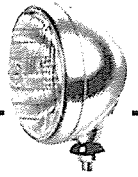

## DETAILED SPARE PARTS

### FF133

Dipping (Double Filament) and Non-dip Models

Part No. . . . .	*50088A	50426A
Model . . . . .	FF133-1P	FF133-1P
Finish . . . . .	C.P.R.	C.P.R.
§Rim or door . . . . .	509744	509744
§ Glass . . . . .	509757	509757
§ Wires, glass fixing . . . . .	509753/S	509753/S
§ Bead, rubber . . . . .	‡509724	‡509724
	506361	506361
§ Reflector . . . . .	509746	509793
§ Bulbholder or interior, main . . . . .	500181	504801
§ Sleeve, terminal . . . . .	555910	555910
§ Bulb holder interior, pilot . . . . .	500181	500181
§ Clip and screw, bulb holder clamping . . . . .	—	551807
§ Bulb, main, 6 volt . . . . .	106	168
§ Bulb, pilot, 6 volt . . . . .	200	200
§ Screw, rim fixing . . . . .	113531	113531
§ Prism . . . . .	509754	509754
§ Wires, prism fixing . . . . .	509749	509749

M42 Dipping (Double Filament) Models

Part No. . . . .	†50292D	†50306D	†50950A
Model . . . . .	M42	M42	M42
Finish . . . . .	Black,	Black,	Black
Replaced by (see footnote) . . . . .	C.P.R.	C.P.R.	Black
	(51906)	(50947)	(51906)
§Rim or door . . . . .	509484	509484	553080
§ Glass . . . . .	550875	550875	550875
§ Wires, glass fixing . . . . .	509753/S	509753/S	509753/S
§ Bead, rubber . . . . .	553065	553065	553065
§ Reflector . . . . .	553148	553147	553148
§ Bulb holder . . . . .	504801	504801	504801
§ Sleeve, terminal . . . . .	555910	555910	555910
§ Bulb holder interior, pilot . . . . .	—	500181	—
§ Clip and screw, bulb holder clamping . . . . .	551807	551807	551807
§ Bulb, 12 volt . . . . .	—	—	171
§ Bulb, 6 volt . . . . .	168	168 ‡200	168
§ Washer, fixing bolt . . . . .	137141	137141	137141
§ Catch, rim fixing . . . . .	509936	509936	509936
§ Spring, rim catch . . . . .	509191	509191	509191
§ Screw, lamp fixing . . . . .	112201	112201	112201

### LBD and MBD133 Dipping (Double Filament) and Non-dip Models—continued

†50201A L133P Black (50364)	†50202A L133P Black (50364)	†50251A MBD133 Chromium (50147)	50261D MBD133-1 Black (50659)	50267D MBD133-2 Chromium —	50268D MBD133-2 Chromium —	50303A L133 Black (50406)	50319B MD133P Black —	50364B MD133P Black —	†50370A L133P-3 Black (50649)
553080	553080	509484	553080	509484	509484	553080	553080	553080	553080 (1)
516199	516199	503403	550875	550875	550875	516144	550875	550875	516199 (2)
500291	500291	500291	509753/S	509753/S	509753/S	500291	509753/S	509753/S	500291 (3)
506361	506361	506361	553065	553065	553065	503631	553065	553065	506361 (4)
*551809	*551809	*508751	553145	553148	553148	553148	553146	553147	— (5)
504801	504801	500181	500181	504801	504801	504801	504804	504801	— (6)
500181	500181	—	—	—	—	—	500181	500181	500181 (7)
—	—	555910	555910	555910	555910	555910	555910	555910	555910 (8)
—	—	—	57	—	—	171	1 ‡207	171 ‡207	171 ‡207 (9)
183 ‡200	183 ‡200	106	—	168	168	—	—	—	— (10)
183940	183940	170290	170290	180377	180377	181261	183940	183940	180377 (11)
188350	188350	188350	188350	188349	188349	188350	188350	188350	188350 (12)
505626	505626	505626	505626	503970	503970	503014	505626	505626	505626 (13)
552255	552255	552255	509936	509936	509936	—	509936	509936	552255 (14)
—	—	—	509191	509191	509191	—	509191	509191	— (15)

### LBD and MBD133—continued

†50632D MD133P-3 Black (50649)	†50633D MD133P-3 Black (50746)	50645A/D MBD133P Chromium —	50646A/D MBD133P Chromium —	†50647B MBD133P Chromium (50645)	†50648B MBD133P Chromium (50646)	50649A/B MD133P-3 Black —	50659B MD133-1 Black, C.P.R. —	50746B MD133P Black —	50929A MD133P Black —
553080	553080	509484	509484	509484	509484	553080	509484	553080	553080 (1)
550875	550875	550875	550875	550875	550875	550875	550875	550875	550875 (2)
509753/S	509753/S	509753/S	509753/S	509753/S	509753/S	509753/S	509753/S	509753/S	509753/S (3)
553065	553065	553065	553065	553065	553065	553065	553065	553065	553065 (4)
553147	553146	553147	553146	553147	553146	553147	553145	553146	553159 (5)
504801	504804	504801	504804	504801	504804	504801	500181	504804	504801 (6)
500181	500181	500181	500181	500181	500181	500181	—	500181	504801 (7)
555910	555910	555910	555910	555910	555910	555910	—	555910	555910 (8)
171 ‡207	57 ‡207	171 ‡207	57 ‡207	—	—	171 ‡207	—	1 ‡207	5 ‡209 (9)
168 ‡200	106 ‡200	—	—	168 ‡200	106 ‡200	168 ‡200	106	106 ‡200	— (10)
180377	180377	183940	183940	183940	183940	180377	170290	180377	183940 (11)
188349	188349	188350	188350	188350	188350	188349	188350	188349	188350 (12)
503970	503970	505626	505626	505626	505626	503970	505626	503970	505626 (13)
509936	509936	509936	509936	509936	509936	509936	509936	509936	509936 (14)
509191	509191	509191	509191	509191	509191	509191	509191	509191	509191 (15)

For illustrations, see pages G7–G8

Note. For replacement lamp spare parts, see appropriate column under part number \* See Supersession Chart † When ordering, quote part number shown in brackets ‡ Body fixing § Recommended spares for stock ¶ Pilot C.P.R. . . Chromium plated rim continued

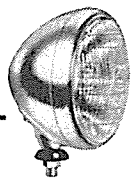

# HEADLAMPS, External Fitting

## DETAILED SPARE PARTS

### LBD and MBD133-EDS Dipping Reflector Models

Part No. . . . .	50081B MBD 133-EDS	50083B MBD 133-EDS	+50141A L133-EDS	50146D MBD 133-EDS	50171D MBD 133-EDS	†50250A LBD 133-1EDS	50260D MD 133-1EDS	50413D MD 133-EDS
Model . . . . .	Chromium	Chromium	Black (50081)	Chromium	Chromium	Chromium (51046)	Black	Black
Finish . . . . .	—	—	—	—	—	—	—	—
Replaced by (see footnote) . . . . .	—	—	—	—	—	—	—	—
§Rim or door . . . . .	509484	509484	553080	509484	509484	509484	553080	553080
§ Glass . . . . .	550875	550875	516144	550875	550875	503403	550875	550875
§ Wires, glass fixing . . . . .	509753/S	509753/S	509753/S	509753/S	509753/S	500291	509753/S	509753/S
§Bead, rubber . . . . .	553065	553065	506361	553065	553065	506361	553065	553065
§Reflector . . . . .	508596	508596	508596	508596	508596	508596	508596	508596
§ Bulb holder or interior . . . . .	500181	500181	500181	500181	500181	500181	500181	500181
§ Sleeve, terminal . . . . .	555910	555910	555910	555910	555910	555910	555910	555910
§Bulb, 12 volt . . . . .	57	—	57	—	—	—	57	57
§Bulb, 6 volt . . . . .	106	106	106	106	106	106	—	—
§Dipper unit . . . . .	57016	57016	57017	57016	57016	57016	57017	57017
§ Fuse . . . . .	188235	188235	188235	188235	188235	188235	188232	188232
§Bracket, action . . . . .	508595	508595	508595	508595	508595	508595	508595	508595
Nut, fixing bolt . . . . .	183940	183940	181261	170290	180377	170290	170290	180377
Washer, fixing bolt . . . . .	188350	188350	—	188350	188349	188350	188350	188349
§Bolt, lamp fixing . . . . .	505626	505626	—	505626	503970	505626	505626	503970
§Catch, rim fixing . . . . .	509936	509936	552255	509936	509936	552255	509936	509936
Spring, rim catch . . . . .	509191	509191	—	509191	509191	—	509191	509191

### MBD134 Dipping (Double Filament) and Non-dip Models

Part No. . . . .	†50086D	50200D	†50216D	50219A/F	50220D	†50221D	†50222D	†50223D	†50224A/D
Model . . . . .	MBD134-1	MD134-1	MD134-1	MD134-1	MD134-1	MD134-1	MD134-1	MD134-1	MD134-1
Finish . . . . .	Chromium	Black, C.P.R.	Primer, C.P.R.	Black, C.P.R.	Black, C.P.R.	Black, C.P.R.	Primer, C.P.R.	Chromium	Chromium
Replaced by (see footnote) . . . . .	—	—	(50200)	—	—	(50219)	(50220)	(50219)	(50220)
§Rim or door . . . . .	509484	509484	509484	509484	509484	509484	509484	509484	509484
§ Glass . . . . .	550875	550875	550875	550875	550875	550875	550875	550875	550875
§ Wires, glass fixing . . . . .	509753/S	509753/S	509753/S	509753/S	509753/S	509753/S	509753/S	509753/S	509753/S
§Bead, rubber . . . . .	553065	553065	553065	553065	553065	553065	553065	553065	553065
§Reflector . . . . .	553145	553145	553145	553148	553148	553148	553148	553148	553148
§ Bulb holder or interior, main . . . . .	500181	500181	500181	504801	504801	504801	504801	504801	504801
§ Sleeve, terminal . . . . .	555910	555910	555910	555910	555910	555910	555910	555910	555910
Clip and screw, bulb holder clamp- ing . . . . .	—	—	—	551807	551807	551807	551807	551807	551807
§Bulb, 12 volt . . . . .	57	57	—	171	171	—	—	171	171
§Bulb, 6 volt . . . . .	106	106	106	169	169	169	169	169	169
Nut, fixing bolt . . . . .	180364	180364	180364	180364	180364	180364	180364	180364	180364
Washer, fixing bolt . . . . .	188349	188349	188349	188349	188349	188349	188349	188349	188349
§Catch, rim fixing . . . . .	509936	509936	509936	509936	509936	509936	509936	509936	509936
Spring, rim catch . . . . .	509191	509191	509191	509191	509191	509191	509191	509191	509191

### MBD134—continued

Part No. . . . .	†51138A	†51139A	†51140A
Model . . . . .	MD 134-1	MD 134-1	MD 134-1
Finish . . . . .	Black	Black	Black
Replaced by (see footnote) . . . . .	(50200)	(50219)	(50220)
§Rim or door . . . . .	553080	553080	553080
§ Glass . . . . .	550875	550875	550875
§ Wires, glass fixing . . . . .	509753/S	509753/S	509753/S
§Bead, rubber . . . . .	553065	553065	553065
§Reflector . . . . .	553145	553148	553148
§ Bulb holder or interior, main . . . . .	500181	504801	504801
§ Sleeve, terminal . . . . .	555910	555910	555910
Clip and screw, bulb holder clamp- ing . . . . .	—	551807	551807
§Bulb, 12 volt . . . . .	57	171	171
§Bulb, 6 volt . . . . .	—	169	169
§Dipper unit . . . . .	—	—	—
Nut, fixing bolt . . . . .	180364	180364	180364
Washer, fixing bolt . . . . .	188349	188349	188349
§Catch, rim fixing . . . . .	509936	509936	509936
Spring, rim catch . . . . .	509191	509191	509191

### MBD134-EDS Dipping Reflector Models

Part No. . . . .	†50087D	50199D	†50215D
Model . . . . .	MBD 134-EDS	MD 134-EDS	MD 134-1EDS
Finish . . . . .	Chromium	Black, C.P.R.	Primer, C.P.R.
Replaced by (see footnote) . . . . .	—	—	(50199)
§Rim or door . . . . .	509484	509484	509484
§ Glass . . . . .	550875	550875	550875
§ Wires, glass fixing . . . . .	509753/S	509753/S	509753/S
§Bead, rubber . . . . .	553065	553065	553065
§Reflector . . . . .	508596	508596	508596
§ Bulb holder, interior . . . . .	500181	500181	500181
§ Sleeve, terminal . . . . .	555910	555910	555910
Clip and screw, bulb holder clamping . . . . .	—	—	—
§Bulb, 12 volt . . . . .	57	—	—
§Bulb, 6 volt . . . . .	—	106	106
§Dipper unit . . . . .	57017	57016	57016
§ Fuse . . . . .	188232	188235	188235
Nut, fixing bolt . . . . .	180364	180364	180364
Washer, fixing bolt . . . . .	188349	188349	188349
§Catch, rim fixing . . . . .	509936	509936	509936
Spring, rim catch . . . . .	509191	509191	509191

For illustrations, see pages G7-G8

Note. For replacement lamp spare parts, see appropriate column under part number † When ordering, quote part number shown in brackets  
 ‡ Complete lamp no longer available; return old unit for repair C.P.R. . . Chromium plated rim

# HEADLAMPS, External Fitting

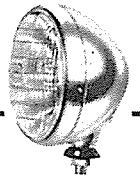

## DETAILED SPARE PARTS

### MBD140-EDS Dipping Reflector Models

Part No. . . . .	†50103A MBD140-EDS Chromium (50752)	†50153A MD140-1EDS Black, C.P.R. (50511)	†50204A M140-EDS Black, C.P.R. (50511)	†50253B MBD140-EDS Chromium (50752)	†50324A MBD140-DP Chromium —	50440A MD140-EDS Black, C.P.R. —
§Rim or door . . . . .	507577	507577	507577	507577	507577	507577
§ Glass . . . . .	551308	551308	516173	551308	504224	507586
§ Wires, glass fixing . . . . .	500291	500291	500291	500291	500291	500291
§Bead, rubber . . . . .	509201	509201	509201	509201	509201	509201
§Reflector . . . . .	508247	508247	508247	508247	—	508247
§ Bulb holder . . . . .	504804	504804	504804	504804	504804	504804
§ Sleeve, terminal . . . . .	555910	555910	555910	555910	555910	555910
Clip and screw, bulb holder clamping . . . . .	551807	551807	551807	551807	551807	551807
§Bulb, 12 volt . . . . .	57	57	57	57	57	57
Nut, fixing bolt . . . . .	180377	180377	180377	180377	180377	180377
Washer, fixing bolt . . . . .	188349	188349	188349	188349	188349	188349
§Catch, rim fixing . . . . .	509936	509936	509936	509936	509936	509936
Spring, rim catch . . . . .	509191	509191	509191	509191	509191	509191
§Bolt, lamp fixing . . . . .	503014	503014	503014	503014	503014	503014
Dipper unit . . . . .	57017	57017	57017	57017	—	57017
Fuse . . . . .	188232	188232	188232	188232	—	188232
Rim, extension . . . . .	508248	508248	508248	508248	—	508248

### MBD140-EDS—continued

Part No. . . . .	†50442A MD140-EDS Black, C.P.R. (50440)	†50452A MD140-EDS Black, C.P.R. (50511)	†50454A MD140-EDS Black, C.P.R. (50511)	†50460D MD140-EDS Black, C.P.R. (50511)	†50478A MD140-EDS Black, C.P.R. (50511)	†50481A MBD140-EDS Chromium (50752)
§Rim or door . . . . .	507577	507577	507577	507577	507577	507577
§ Glass . . . . .	507586	507586	507586	507586	507586	507586
§ Wires, glass fixing . . . . .	500291	500291	500291	500291	500291	500291
§Bead, rubber . . . . .	509201	509201	509201	509201	509201	509201
§Reflector . . . . .	508247	508247	508247	508247	508247	508247
§ Bulb holder . . . . .	504804	504804	504804	504804	504804	504804
§ Sleeve, terminal . . . . .	555910	555910	555910	555910	555910	555910
Clip and screw, bulb holder clamping . . . . .	551807	551807	551807	551807	551807	551807
§Bulb, 12 volt . . . . .	57	57	57	57	57	57
Nut, fixing bolt . . . . .	180377	551318	551318	—	180377	180377
Washer, fixing bolt . . . . .	188349	188349	188349	—	188349	188349
§Catch, rim fixing . . . . .	509936	509936	509936	509936	509936	509936
Spring, rim catch . . . . .	509191	509191	509191	509191	509191	509191
§Bolt, lamp fixing . . . . .	503014	503014	503014	503014	503014	503014
Dipper unit . . . . .	57017	57017	57017	57017	57017	57017
Fuse . . . . .	188232	188232	188232	188232	188232	188232
Rim, extension . . . . .	508248	508248	508248	508248	508248	508248

### MBD140-EDS—continued

Part No. . . . .	50511A MD 140-EDS Black, C.P.R. —	†50515A MD 140-1EDS Primer, C.P.R. (50511)	†50583A MD 140-EDS Black, C.P.R. (50511)	†50595A MBD 140-EDS Chromium (50752)	†50596A MBD 140-EDS Chromium (50752)	†50716D MBD 140-EDS Chromium (50752)	50752A MBD 140-EDS Chromium —
§Rim or door . . . . .	507577	507577	507577	507577	507577	507577	507577
§ Glass . . . . .	507586	507586	507586	507586	507586	508576	507586
§ Wires, glass fixing . . . . .	500291	500291	500291	500291	500291	500291	500291
§Bead, rubber . . . . .	509201	509201	509201	509201	509201	509201	509201
§Reflector . . . . .	508247	508247	508247	508247	508247	508247	508247
§ Bulb holder . . . . .	504804	504804	504804	504804	504804	504804	504804
§ Sleeve, terminal . . . . .	555910	555910	555910	555910	555910	555910	555910
Clip and screw, bulb holder clamping . . . . .	551807	551807	551807	551807	551807	551807	551807
§Bulb, 12 volt . . . . .	57	57	57	57	57	57	57
Nut, fixing bolt . . . . .	180377	180377	180377	180377	180377	180377	180377
Washer, fixing bolt . . . . .	188349	188349	188349	188349	188349	188349	188349
§Catch, rim fixing . . . . .	509936	509936	509936	509936	509936	509936	509936
Spring, rim catch . . . . .	509191	509191	509191	509191	509191	509191	509191
§Bolt, lamp fixing . . . . .	503014	503014	503014	503014	503014	503014	503014
Dipper unit . . . . .	57017	57017	57017	57017	57017	57017	57017
Fuse . . . . .	188232	188232	188232	188232	188232	188232	188232
Rim, extension . . . . .	508248	508248	508248	508248	508248	508248	508248

For illustrations, see pages G7-G8

Note. For replacement lamp spare parts, see appropriate column under part number † When ordering, quote part number shown in brackets  
 ‡ Complete lamp no longer available; return old unit for repair § Recommended spares for stock C.P.R. . . . Chromium plated rim

continued

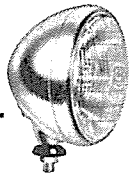

# HEADLAMPS, External Fitting

## DETAILED SPARE PARTS

### MD, MBD and MBL140 Dipping (Double Filament) and Non-dip Models

Part No. Model Finish Replaced by (see footnote)	†50102A MBD140 Chromium (50753)	†50154A MD140-1 Black, C.P.R. (50512)	†50205A M140 Black, C.P.R. (50512)	†50245A MD140 Black, C.P.R. (50519)	†50254B MBD140 Chromium (50753)	†50291A MBD140 Chromium (50523)	†50323A MBD140 Chromium (50753)
(1) §Rim or door	507577	507577	507577	507577	507577	507577	507577
(2) § Glass	551308	551308	516173	551308	551308	551308	504224
(3) § Wires, glass fixing	500291	500291	500291	500291	500291	500291	500291
(4) §Bead, rubber	509201	509201	509201	509201	509201	509201	509201
(5) §Reflector or light unit	506854	506854	506854	506855	506854	506855	506854
(6) § Bulb holder, main	504804	504804	504804	504801	504804	504801	504804
(7) § Sleeve, terminal	555910	555910	555910	555910	555910	555910	555910
(8) Clip and screw, bulb holder clamping	551807	551807	551807	551807	551807	551807	551807
(9) §Bulb, 12 volt	57	57	57	171	57	171	57
(10) Nut, fixing bolt	180377	180377	180377	180377	180377	180377	180377
(11) Washer, fixing bolt	188349	188349	188349	188349	188349	188349	188349
(12) §Catch, rim fixing	509936	509936	509936	509936	509936	509936	509936
(13) Spring, rim catch	509191	509191	509191	509191	509191	509191	509191
(14) §Bolt, lamp fixing	503014	503014	503014	503014	503014	503014	503014

### MD, MBD and MBL140—continued

Part No. Model Finish Replaced by (see footnote)	†50465A MD140 Black, C.P.R. (50607)	†50482A MBD140 Chromium (50753)	†50483A MBD140 Chromium (50523)	†50490A MBD140 Chromium (50753)	†50491A MBD140 Chromium (50753)	50512A MD140 Black, C.P.R. —	†50516A MD140 Primer, C.P.R. (50512)
(1) §Rim or door	507577	507577	507577	507577	507577	507577	507577
(2) § Glass	507586	507586	507586	507586	507586	507586	507586
(3) § Wires, glass fixing	500291	500291	500291	500291	500291	500291	500291
(4) §Bead, rubber	509201	509201	509201	509201	509201	509201	509201
(5) §Reflector or light unit	506855	506854	506855	506854	506854	506854	506854
(6) § Bulb holder, main	504801	504804	504801	504804	504804	504804	504804
(7) § Sleeve, terminal	555910	555910	555910	555910	555910	555910	555910
(8) Clip and screw, bulb holder clamping	551807	551807	551807	551807	551807	551807	551807
(9) §Bulb, 12 volt	171	57	171	57	57	57	57
(10) Nut, fixing bolt	—	180377	180377	180377	180377	180377	180377
(11) Washer, fixing bolt	—	188349	188349	188349	188349	188349	188349
(12) §Catch, rim fixing	509936	509936	509936	509936	509936	509936	509936
(13) Spring, rim catch	509191	509191	509191	509191	509191	509191	509191
(14) §Bolt, lamp fixing	503014	503014	503014	503014	503014	503014	503014

### MD and MBD141 Dipping (Double Filament) and Non-dip Models

Part No. Model Finish Replaced by (see footnote)	†50197A MBD141 Chromium —	†50218A MD141 Black, C.P.R. —	†50227A MD141 Black, C.P.R. —	†50228A MD141 Black, C.P.R. —	†50231A MBD141 Chromium (50565)	†50232A MBD141 Chromium —
(1) §Rim or door	507577	507577	507577	507577	507577	507577
(2) § Glass	507586	507586	507586	507586	507586	507586
(3) § Wires, glass fixing	500291	500291	500291	500291	500291	500291
(4) §Bead, rubber	509201	509201	509201	509201	509201	509201
(5) §Reflector or light unit	506854	506854	506855	506855	506855	506855
(6) § Bulb holder, main	504804	504804	504801	504801	504801	504801
(7) § Sleeve, terminal	555910	555910	555910	555910	555910	555910
(8) Clip and screw, bulb holder clamping	551807	551807	551807	551807	551807	551807
(9) §Bulb, 12 volt	57	—	—	—	—	—
(10) §Bulb, 6 volt	—	106	169	169	169	169
(11) Nut, fixing bolt	180364	180377	180377	180377	180377	180377
(12) Washer, fixing bolt	188349	188349	188349	188349	188349	188349
(13) §Catch, rim fixing	509936	509936	509936	509936	509936	509936
(14) Spring, rim catch	509191	509191	509191	509191	509191	509191

For illustrations, see pages G7–G8

Note. For replacement lamp spare parts, see appropriate column under part number † When ordering, quote part number shown in brackets  
 ‡ Complete lamp no longer available; return old unit for possible repair § Recommended spares for stock C.P.R. ... Chromium plated rim

# HEADLAMPS, External Fitting

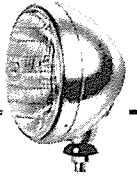

## DETAILED SPARE PARTS

### MD, MBD and MBL140 Dipping (Double Filament) and Non-dip Models—*continued*

†50427A MD140 Black, C.P.R. (50606)	†50439A MD140 Black, C.P.R. (50606)	50441A MD140 Black, C.P.R. —	†50443A MD140 Black, C.P.R. (50441)	†50453A MD140 Black, C.P.R. (50512)	†50455A MD140 Black, C.P.R. (50512)	†50458A MBD140 Chromium (50523)	†50459A MBD140 Chromium (50523)	†50461D MD140-1 Black, C.P.R. (50512)	†50464A MD140 Black, C.P.R. (50607)
507577	507577	507577	507577	507577	507577	507577	507577	507577	507577 (1)
507586	507586	507586	507586	507586	507586	507586	507586	507586	507586 (2)
500291	500291	500291	500291	500291	500291	500291	500291	500291	500291 (3)
509201	509201	509201	509201	509201	509201	509201	509201	509201	509201 (4)
506855	506855	506854	506854	506854	506854	506855	506855	506854	506855 (5)
504801	504801	504804	504804	504804	504804	504801	504801	504804	504801 (6)
555910	555910	555910	555910	555910	555910	555910	555910	555910	555910 (7)
551807	551807	551807	551807	551807	551807	551807	551807	551807	551807 (8)
171	171	57	57	57	57	171	171	57	171 (9)
—	—	180377	180377	551318	551318	180377	180377	—	— (10)
—	—	188349	188349	188349	188349	188349	188349	—	— (11)
509936	509936	509936	509936	509936	509936	509936	509936	509936	509936 (12)
509191	509191	509191	509191	509191	509191	509191	509191	509191	509191 (13)
503014	503014	503014	503014	503014	503014	503014	503014	503014	503014 (14)

### MD, MBD and MBDL140—*continued*

50519A MD140 Black, C.P.R. —	50523A MBD140 Chromium —	†50584A MD140-1 Black, C.P.R. (50512)	†50585A MD140-1 Black, C.P.R. (50519)	50606B M140 Black —	50607B M140 Black —	†50717D MBD140 Chromium (50753)	†50718F MBD140 Chromium (50523)	50753A MBD140 Chromium —	51473A MBL140 Chromium —
507577	507577	507577	507577	551361	551361	507577	507577	507577	553435 (1)
507586	507586	507586	507586	507586	507586	507586	507586	507586	— (2)
500291	500291	500291	500291	500291	500291	500291	500291	500291	553356 (3)
509201	509201	509201	509201	509201	509201	509201	509201	509201	— (4)
506855	506855	506854	506855	506855	506855	506854	506855	506854	553921 (5)
504801	504801	504804	504801	504801	504801	504804	504801	504804	860895 (6)
555910	555910	555910	555910	555910	555910	555910	555910	555910	555910 (7)
551807	551807	551807	551807	551807	551807	551807	551807	551807	— (8)
171	171	57	171	171	171	57	171	57	354 (9)
180377	180377	180377	180377	180377	180377	180377	180377	180377	180377 (10)
188349	188349	188349	188349	188349	188349	188349	188349	188349	188349 (11)
509936	509936	509936	509936	509936	509936	509936	509936	509936	509936 (12)
509191	509191	509191	509191	509191	509191	509191	509191	509191	509191 (13)
503014	503014	503014	503014	503014	503014	503014	503014	503014	503014 (14)

### MD and MBD141 Dipping (Double Filament) and Non-dip Models—*continued*

†50379A MBD141 Chromium (50565)	†50380A MBD141 Chromium —	†50556A MD141 Black, C.P.R. —	†50558A MD141 Primer, C.P.R. —	†50561A MD141E Black, C.P.R. —	†50562A MD141E Black, C.P.R. —	50565A MBD141E Chromium —	†50566A MBD141E Chromium —	50720A MBD141 Chromium —
507577	507577	507577	507577	507577	507577	507577	507577	507577 (1)
507586	507586	507586	507586	507586	507586	507586	507586	507586 (2)
500291	500291	500291	500291	500291	500291	500291	500291	500291 (3)
509201	509201	509201	509201	509201	509201	509201	509201	509201 (4)
506855	506855	506854	506854	506855	506855	506855	506855	506854 (5)
504801	504801	504804	504804	504801	504801	504801	504801	504804 (6)
555910	555910	555910	555910	555910	555910	555910	555910	555910 (7)
551807	551807	551807	551807	551807	551807	551807	551807	551807 (8)
171	171	57	57	171	171	171	171	57 (9)
—	—	—	—	—	—	—	—	— (10)
180364	180364	180377	180377	180377	180377	180377	180377	180364 (11)
188349	188349	188349	188349	188349	188349	188349	188349	188349 (12)
509936	509936	509936	509936	509936	509936	509936	509936	509936 (13)
509191	509191	509191	509191	509191	509191	509191	509191	509191 (14)

For illustrations, see pages G7-G8

Note. For replacement lamp spare parts, see appropriate column under part number † When ordering, quote part number shown in brackets  
‡ Complete lamp no longer available; return unit for possible repair C.P.R. ... Chromium plated rim

*continued*

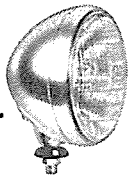

# HEADLAMPS, External Fitting

## DETAILED SPARE PARTS

### MD and MBD141-EDS Dipping Reflector Models

Part No. . . . .	‡50196A MBD141-EDS Chromium	‡50217A MD141-EDS Black, C.P.R.	‡50555A MD141-EDS Black, C.P.R.	‡50557A MD141-EDS Primer, C.P.R.	50719A MBD141-EDS Chromium
Model . . . . .	—	—	—	—	—
Finish . . . . .	—	—	—	—	—
Replaced by (see footnote)	—	—	—	—	—
§Rim or door . . . . .	507577	507577	507577	507577	507577
§ Glass . . . . .	507586	507586	507586	507586	507586
§ Wires, glass fixing . . . . .	500291	500291	500291	500291	500291
§Bead, rubber . . . . .	509201	509201	509201	509201	509201
§Reflector . . . . .	508247	508247	508247	508247	508247
§ Bulb holder, main . . . . .	504804	504804	504804	504804	504804
§ Sleeve, terminal . . . . .	555910	555910	555910	555910	555910
Clip and screw, bulb holder clamping	551807	551807	551807	551807	551807
§Bulb, main, 12 volt . . . . .	57	—	57	57	57
§Bulb, main, 6 volt . . . . .	—	106	—	—	—
§Dipper unit . . . . .	57017	57016	57017	57017	57017
§ Fuse . . . . .	188232	188235	188232	188232	188232
Rim, extension . . . . .	508248	508248	508248	508248	508248
Nut, fixing bolt . . . . .	180364	180377	180377	180377	180364
Washer, fixing bolt . . . . .	188349	188349	188349	188349	188349
§Catch, rim fixing . . . . .	509936	509936	509936	509936	509936
Spring, rim catch . . . . .	509191	509191	509191	509191	509191

### MD, MBD and ML143 Dipping (Double Filament) and Non-dip Models

Part No. . . . .	‡50108A MBD143 Chromium	‡50300B MBD143 Chromium (50709)	50301B MBD143 Chromium	‡50403A MD143 Black, C.P.R. (50712)	‡50589A/D MD143 Black, C.P.R. (50712)
Model . . . . .	—	—	—	—	—
Finish . . . . .	—	—	—	—	—
Replaced by (see footnote)	—	—	—	—	—
(1) §Rim or door . . . . .	507577	507577	507577	507577	507577
(2) § Glass . . . . .	551308	551308	551308	551308	507586
(3) § Wires, glass or light unit fixing . . . . .	500291	500291	500291	500291	500291
(4) §Bead, rubber . . . . .	509201	509201	509201	509201	509201
(5) §Reflector or light unit . . . . .	506854	506855	506855	506854	506854
(6) § Bulb holder . . . . .	504804	504801	504801	504804	504804
(7) § Sleeve, terminal . . . . .	555910	555910	555910	555910	555910
(8) Clip and screw, bulb holder clamp- ing . . . . .	551807	551807	551807	551807	551807
(9) §Bulb, 12 volt . . . . .	57	171	171	57	57
(10) Nut, fixing bolt . . . . .	505527	505527	505527	505527	505527
(11) Washer, fixing bolt . . . . .	188353	188353	188353	188353	188353
(12) §Catch, rim fixing . . . . .	509936	509936	509936	509936	509936
(13) Spring, rim catch . . . . .	509191	509191	509191	509191	509191
(14) §Bolt, lamp fixing . . . . .	505525	505525	505525	505525	505525

### MD, MBD and ML143—continued

Part No. . . . .	50709A MBD143 Chromium	50710A MBD143 Chromium	50712A MD143 Black, C.P.R.	50713A MD143 Black, C.P.R.	50714A MD143 Black, C.P.R.
Model . . . . .	—	—	—	—	—
Finish . . . . .	—	—	—	—	—
Replaced by (see footnote)	—	—	—	—	—
(1) §Rim or door . . . . .	507577	507577	507577	507577	507577
(2) § Glass . . . . .	507586	507586	507586	507586	507586
(3) § Wires, glass or light unit fixing . . . . .	500291	500291	500291	500291	500291
(4) §Bead, rubber . . . . .	509201	509201	509201	509201	509201
(5) §Reflector or light unit . . . . .	506855	506855	506854	506855	506855
(6) § Bulb holder . . . . .	504801	504801	504804	504801	504801
(7) § Sleeve, terminal . . . . .	555910	555910	555910	555910	555910
(8) Clip and screw, bulb holder clamp- ing . . . . .	551807	551807	551807	551807	551807
(9) §Bulb, 12 volt . . . . .	171	171	57	171	171
(10) Nut, fixing bolt . . . . .	505527	505527	505527	505527	505527
(11) Washer, fixing bolt . . . . .	188353	188353	188353	188353	188353
(12) §Catch, rim fixing . . . . .	509936	509936	509936	509936	509936
(13) Spring, rim catch . . . . .	509191	509191	509191	509191	509191
(14) §Bolt, lamp fixing . . . . .	505525	505525	505525	505525	505525

For illustrations, see pages G7-G8

Note. For replacement lamp spare parts, see appropriate column under part number † When ordering, quote part number shown in brackets  
 ‡ Complete lamp no longer available; return old unit for possible repair § Recommended spares for stock C.P.R. . . . Chromium plated rim



# HEADLAMPS, External Fitting

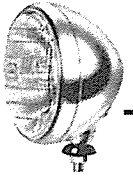

## DETAILED SPARE PARTS

### MD and MBD143-EDS Dipping Reflector Models

Part No. . . . .	†50107A MBD143-EDS Chromium (50707)	†50402A MD143-EDS Black, C.P.R. (50711)	†50588A/D MD143-EDS Black, C.P.R. (50711)	†50591A MBD143-EDS Chromium (50707)	50707A MBD143-EDS Chromium —	50711A MD143-EDS Black, C.P.R. —
§Rim or door . . . . .	507577	507577	507577	507577	507577	507577
§ Glass . . . . .	551308	551308	507586	507586	507586	507586
§ Wires, glass fixing . . . . .	500291	500291	500291	500291	500291	500291
§ Bead, rubber . . . . .	509201	509201	509201	509201	509201	509201
§ Reflector . . . . .	508247	508247	508247	508247	508247	508247
§ Bulb holder . . . . .	504804	504804	504804	504804	504804	504804
§ Sleeve, terminal . . . . .	555910	555910	555910	555910	555910	555910
Clip and screw, bulb holder clamping	551807	551807	551807	551807	551807	551807
§ Bulb, 12 volt . . . . .	57	57	57	57	57	57
§ Dipper unit . . . . .	57017	57017	57017	57017	57017	57017
§ Fuse . . . . .	188232	188232	188232	188232	188232	188232
Rim, extension . . . . .	508248	508248	508248	508248	508248	508248
Nut, fixing bolt . . . . .	505527	505527	505527	505527	505527	505527
Washer, fixing bolt . . . . .	188353	188353	188353	188353	188353	188353
§ Catch, rim fixing . . . . .	509936	509936	509936	509936	509936	509936
Spring, rim catch . . . . .	509191	509191	509191	509191	509191	509191
§ Bolt, lamp fixing . . . . .	505525	505525	505525	505525	505525	505525

### MD, MBD and ML143 Dipping (Double Filament) and Non-dip Models—continued

†50592A MBD143 Chromium —	†50593A MBD143 Chromium (50709)	50594A MBD143 Chromium —	‡50602A MD143 Black, C.P.R. —	50603A MD143 Black, C.P.R. —	50672A MD143EF Black, C.P.R. —	50673A MD143EF Black, C.P.R. —	50708A MBD143 Chromium —
507577	507577	507577	507577	507577	507577	507577	507577 (1)
507586	507586	507586	507586	507586	507586	507586	507586 (2)
500291	500291	500291	500291	500291	500291	500291	500291 (3)
509201	509201	509201	509201	509201	509201	509201	509201 (4)
506854	506855	506855	506855	506855	508278	508278	506854 (5)
504804	504801	504801	504801	504801	562303	562303	504804 (6)
555910	555910	555910	555910	555910	555910	555910	555910 (7)
551807	551807	551807	551807	551807	562306	562306	551807 (8)
57	171	171	171	171	—	—	57 (9)
505527	505527	505527	505527	505527	505527	505527	505527 (10)
188353	188353	188353	188353	188353	188353	188353	188353 (11)
509936	509936	509936	509936	509936	509936	509936	509936 (12)
509191	509191	509191	509191	509191	509191	509191	509191 (13)
505525	505525	505525	505525	505525	505525	505525	505525 (14)

### MD, MBD and ML143—continued

51644A/D ML143 Black, C.P.R. —	51645A/D ML143 Black, C.P.R. —	51671A ML143 Chromium —	51673A ML143 Chromium —	51674A ML143 Chromium —	51675A ML143EF Chromium —	51676A ML143EF Chromium —	51677A/B ML143 Chromium —	51678A/B ML143 Chromium —
553435	553435	553435	553435	553435	553435	553435	553435	553435 (1)
—	—	—	—	—	—	—	—	— (2)
553356	553356	553356	553356	553356	553356	553356	553356	553356 (3)
—	—	—	—	—	—	—	—	— (4)
553921	553921	555447	553940	553940	553948	553948	553921	553921 (5)
554602	554602	554602	554602	554602	562303	562303	554602	554602 (6)
555910	555910	555910	555910	555910	555910	555910	555910	555910 (7)
—	—	—	—	—	562306	562306	—	— (8)
354	354	355	370	370	—	—	354	354 (9)
505527	505527	505527	505527	505527	505527	505527	505527	505527 (10)
188353	188353	188353	188353	188353	188353	188353	188353	188353 (11)
509936	509936	509936	509936	509936	509936	509936	509936	509936 (12)
509191	509191	509191	509191	509191	509191	509191	509191	509191 (13)
505525	505525	505525	505525	505525	505525	505525	505525	505525 (14)

For illustrations, see pages G7-G8

Note. For replacement lamp spare parts, see appropriate column under part number † When ordering, quote part number shown in brackets  
 ‡ Complete lamp no longer available; return old unit for possible repair § Recommended spares for stock C.P.R. . . Chromium plated rim

continued

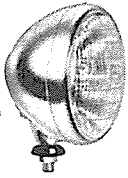

# HEADLAMPS, External Fitting

## DETAILED SPARE PARTS

### MD and MBD145-EDS Dipping Reflector Models

Part No. . . . .	‡50194A MD145-EDS Black, C.P.R.	‡50233A MD145-EDS Primer, C.P.R.
Model . . . . .		
Finish . . . . .		
Replaced by (see footnote) . . . . .		
§Rim or door . . . . .	507577	507577
§ Glass . . . . .	507586	507586
§ Wires, glass fixing . . . . .	504665	504665
§Bead, rubber . . . . .	509201	509201
§Reflector . . . . .	508247	508247
§ Bulb holder . . . . .	504804	504804
§ Sleeve, terminal . . . . .	555910	555910
Clip and screw, bulb holder clamping . . . . .	551807	551807
§Bulb, main, 12 volt . . . . .	57	57
§Dipper unit . . . . .	57017	57017
§ Fuse . . . . .	188232	188232
Rim, extension . . . . .	508248	508248
Nut, fixing bolt . . . . .	180377	180377
Washer, fixing bolt . . . . .	188349	188349
§Catch, rim fixing . . . . .	509936	509936
Spring, rim catch . . . . .	509191	509191

### MD and MBD145 Dipping (Double Filament) and Non-dip Models

Part No. . . . .	‡50195A MD145 Black, C.P.R.	‡50234A MD145 Primer, C.P.R.	‡50235A MD145 Black, C.P.R.	* ‡50236A MD145 Black, C.P.R.	‡50237A MD145 Primer, C.P.R.	‡50238A MD145 Primer, C.P.R.
Model . . . . .						
Finish . . . . .						
Replaced by (see footnote) . . . . .						
§Rim or door . . . . .	507577	507577	507577	507577	507577	507577
§ Glass . . . . .	507586	507586	507586	507586	507586	507586
§ Wires, glass fixing . . . . .	504665	504665	504665	504665	504665	504665
§Bead, rubber . . . . .	509201	509201	509201	509201	509201	509201
§Reflector . . . . .	506854	506854	506855	506855	506855	506855
§ Bulb holder . . . . .	504804	504804	504801	504801	504801	504801
§ Sleeve, terminal . . . . .	555910	555910	555910	555910	555910	555910
Clip and screw, bulb holder clamping . . . . .	551807	551807	551807	551807	551807	551807
§Bulb, 12 volt . . . . .	57	57	171	171	171	171
Nut, fixing bolt . . . . .	180377	180377	180377	180377	180377	180377
Washer, fixing bolt . . . . .	188349	188349	188349	188349	188349	188349
§Catch, rim fixing . . . . .	509936	509936	509936	509936	509936	509936
Spring, rim catch . . . . .	509191	509191	509191	509191	509191	509191

### M147 and MBD147 Dipping (Double Filament) and Non-dip Models

Part No. . . . .	‡50096A MBD147 Chromium	‡50156A MBD147-3 Chromium	‡50175A MBD147-4 Chromium	50177A MBD147-1 Chromium	‡50274A MBD147-1 Chromium (50177)
Model . . . . .					
Finish . . . . .					
Replaced by (see footnote) . . . . .					
(1) Rim or door . . . . .	507577	507577	507577	507577	507577
(2) § Glass . . . . .	551308	507586	504224	507586	507586
(3) § Wires, glass fixing . . . . .	500291	500291	500291	500291	500291
(4) §Bead, rubber . . . . .	509201	509201	509201	509201	509201
(5) §Reflector . . . . .	506854	506854	506854	506854	506855
(6) § Bulb holder . . . . .	504804	504804	504804	504804	504801
(7) § Sleeve, terminal . . . . .	555910	555910	555910	555910	555910
(8) Clip and screw, bulb holder clamping . . . . .	551807	551807	551807	551807	551807
(9) §Bulb, 12 volt . . . . .	57	57	57	57	171
(10) Nut, fixing bolt . . . . .	180377	180377	533537	180377	180377
(11) Washer, fixing bolt . . . . .	188349	188349	188349	188349	188349
(12) Catch, rim fixing . . . . .	509936	509936	509936	509936	509936
(13) Spring, rim catch . . . . .	509191	509191	509191	509191	509191
(14) §Bolt, lamp fixing . . . . .	503970	503970	504177	504177	504177

For illustrations, see pages G7-G8

Note. For replacement spare parts, see appropriate column under part number † When ordering, quote part number shown in brackets  
 ‡ Complete lamp no longer available; return old unit for possible repair § Recommended spares for stock C.P.R. . . . Chromium plated rim

# HEADLAMPS, External Fitting

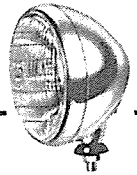

## DETAILED SPARE PARTS

### MBD147-EDS Dipping Reflector Models

Part No. . . . .	‡50095A MBD 147-EDS Chromium	‡50155A MBD 147-EDS Chromium	†50174A MBD 147-EDS Chromium (50500)	50176A MBD 147-EDS Chromium	‡50431A M147P-EDS Black, C.P.R.	50500A MBD 147-EDS Chromium	‡50624A MBD 147-EDS Chromium
§ Rim or door . . . . .	507577	507577	507577	507577	507577	507577	507577
§ Glass . . . . .	551308	507586	507586	507586	516173	507586	507586
§ Wires, glass fixing . . . . .	500291	500291	500291	500291	500921	500291	500291
§ Bead, rubber . . . . .	509201	509201	509201	509201	509201	509201	509201
§ Reflector . . . . .	508247	508247	508247	508247	—	508247	508247
§ Bulb holder . . . . .	504804	504804	504804	504804	504804	504804	504804
§ Sleeve, terminal . . . . .	555910	555910	555910	555910	555910	555910	555910
Clip and screw, bulb holder clamping . . . . .	551807	551807	551807	551807	551807	551807	551807
§ Bulb, 12 volt . . . . .	57	57	57	57	57 ‡207	57	57
§ Dipper unit . . . . .	57017	57017	57017	57017	57017	57017	57017
§ Fuse . . . . .	188232	188232	188232	188232	188232	188232	188232
Rim, extension . . . . .	508248	508248	508248	508248	508248	508248	508248
Nut, fixing bolt . . . . .	180377	180377	180377	180377	551318	533537	180377
Washer, fixing bolt . . . . .	188349	188349	188349	188349	188349	188349	188349
§ Catch, rim fixing . . . . .	509936	509936	509936	509936	509936	509936	509936
Spring, rim catch . . . . .	509191	509191	509191	509191	509191	509191	509191
§ Bolt or screw, lamp fixing . . . . .	503970	503970	504177	504177	503014	504177	—

### MBPL147 Dipping (Double Filament) Models

Part No. . . . .	‡50892A MBPL147 Chromium	‡A50892A MBPL147 Chromium	‡B50892A MBPL147 Chromium	‡50893A MBPL147 Chromium	‡50894A MBPL147 Chromium	‡A50894A MBPL147 Chromium	‡B50894A MBPL147 Chromium	51331A MBPL147 Chromium
§ Rim or door . . . . .	506860	506860	506860	506860	506860	506860	506860	506860
§ Wires, light unit fixing . . . . .	553356	553356	553356	553356	553356	553356	553356	553356
§ Bead, rubber . . . . .	509201	509201	509201	509201	509201	509201	509201	509201
§ Light unit . . . . .	553961	553961	553961	553961	553961	553961	553961	553961
§ Bulb holder . . . . .	554602	554602	554602	554607	554602	554602	554602	554602
§ Sleeve, terminal . . . . .	555910	555910	555910	555910	555910	555910	555910	555910
Clip and screw, bulb holder . . . . .	562306	562306	562306	562306	562306	562306	562306	562306
§ Bulb, 12 volt . . . . .	302	303	370	185	302	303	370	302
Nut, fixing bolt . . . . .	180377	180377	180377	180377	180377	180377	180377	180377
Washer, fixing bolt . . . . .	188349	188349	188349	188349	188349	188349	188349	188349
§ Catch, rim fixing . . . . .	509936	509936	509936	509936	509936	509936	509936	509936
Spring, rim catch . . . . .	509191	509191	509191	509191	509191	509191	509191	509191

### M147 and MBD147 Dipping (Double Filament) and Non-dip Models—continued

†50304A MBD147-3 Chromium (50634)	‡50305A MBD147-3 Chromium	‡50432A M147P Black, C.P.R.	50507A MBD147-4 Chromium	†50508A MBD147-4 Chromium	†50625A MBD147-3 Chromium	50634A MBD147-3 Chromium	‡50635A MBD147-3 Chromium
507577	507577	507577	507577	507577	507577	507577	507577 (1)
507586	507586	516173	507586	507586	507586	507586	507586 (2)
500291	500291	500291	500291	500291	500291	500291	500291 (3)
509201	509201	509201	509201	509201	509201	509201	509201 (4)
506855	506855	*511827	506855	506855	506854	506855	506855 (5)
504801	504801	504804	504801	504801	504804	504801	504801 (6)
555910	555910	555910	555910	555910	555910	555910	555910 (7)
551807	551807	551807	551807	551807	551807	551807	551807 (8)
171	171	57 ‡207	171	171	57	171	171 (9)
180377	180377	551318	533537	533537	180377	180377	180377 (10)
188349	188349	188349	188349	188349	188349	188349	188349 (11)
509936	509936	509936	509936	509936	509936	509936	509936 (12)
509191	509191	509191	509191	509191	509191	509191	509191 (13)
503970	503970	503014	504177	504177	—	503970	503014 (14)

For illustrations, see pages G7-G8

Note. For replacement lamp spare parts, see appropriate column under part number \* See Supersession Chart  
 † When ordering, quote part number shown in brackets ‡ Complete lamp no longer available; return old unit for possible repair  
 § Recommended spares for stock † Pilot C.P.R. . . Chromium plated rim

continued

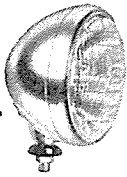

# HEADLAMPS, External Fitting

## DETAILED SPARE PARTS

### MD and MBD148 Dipping (Double Filament) and Non-dip Models

Part No. . . . .	†50098A MBD148 Chromium (50473)	†50210A MBD148 Chromium (50473)	†50211A MBD148 Chromium (50473)	‡50314B MBD148S Chromium —	‡50315B MBD148S Chromium —	‡50383B MBD148S Chromium —	‡50384B MBD148S Chromium —
(1) §Rim or door . . . . .	507577	507577	507577	507577	507577	507577	507577
(2) § Glass . . . . .	551308	551308	551308	507586	507586	507586	507586
(3) § Wires, glass fixing . . . . .	500291	500291	500291	500291	500291	500291	500291
(4) § Bead, rubber . . . . .	509201	509201	509201	509201	509201	509201	509201
(5) § Reflector . . . . .	506854	506854	506854	506855	506855	506854	506854
(6) § Bulb holder . . . . .	504804	504804	504804	504801	504801	504804	504804
(7) § Sleeve, terminal . . . . .	555910	555910	555910	555910	555910	555910	555910
(8) Clip and screw, bulb holder clamping . . . . .	551807	551807	551807	551807	551807	551807	551807
(9) § Bulb, 12 volt . . . . .	57	57	57	171	171	57	57
(10) Nut, fixing bolt . . . . .	180377	—	180377	503053	503053	503053	503053
(11) Washer, fixing bolt . . . . .	188349	—	188349	188349	188349	188349	188349
(12) § Catch, rim fixing . . . . .	509936	509936	509936	509936	509936	509936	509936
(13) Spring, rim catch . . . . .	509191	509191	509191	509191	509191	509191	509191
(14) § Bolt, lamp fixing . . . . .	503014	503014	503014	503014	503014	503014	503014

### MBD148-EDS Dipping Reflector Models

Part No. . . . .	†50213A MBD 148-EDS Chromium —	‡50433A MD 148P-EDS Black, C.P.R. —	50472A MBD 148-EDS Chromium —	†50474A MBD 148-EDS Chromium (50472)
§Rim or door . . . . .	507577	507577	507577	507577
§ Glass . . . . .	551308	507586	507586	507586
§ Wires, glass fixing . . . . .	500291	500291	500291	500291
§ Bead, rubber . . . . .	509201	509201	509201	509201
§ Reflector . . . . .	508247	—	508247	508247
§ Bulb holder, main or pilot . . . . .	504804	504804	504804	504804
§ Sleeve, terminal . . . . .	555910	555910	555910	555910
Clip and screw, bulb holder clamping . . . . .	551807	—	551807	551807
§ Bulb, 12 volt . . . . .	57	57 ‡207	57	57
§ Dipper unit . . . . .	57017	57017	57017	57017
§ Fuse . . . . .	188232	188232	188232	188232
Rim, extension . . . . .	508248	508248	508248	508248
Nut, fixing bolt . . . . .	—	180377	—	—
Washer, fixing bolt . . . . .	—	188349	—	—
§ Catch, rim fixing . . . . .	509936	509936	509936	509936
Spring, rim catch . . . . .	509191	509191	509191	509191
§ Bolt, lamp fixing . . . . .	503014	503014	503014	503014

### M and MB150-EDS Dipping Reflector Models

Part No. . . . .	†50336A M 150-EDS Black, C.P.R. (50440)	†50344A MB 150-EDS Chromium (50752)
§Rim or door . . . . .	551075	551075
§ Glass . . . . .	510770	505975
§ Wires, glass fixing . . . . .	500291	500291
§ Bead, rubber . . . . .	507088	507088
§ Reflector . . . . .	501875	501875
§ Bulb holder, main . . . . .	504804	504804
§ Sleeve, terminal . . . . .	555910	555910
Clip and screw, bulb holder clamping . . . . .	551807	551807
§ Bulb, 12 volt . . . . .	57	57
§ Dipper unit . . . . .	57017	57017
§ Fuse . . . . .	188232	188232
Rim, extension . . . . .	507080	507080
Nut, fixing bolt . . . . .	180377	180377
Washer, fixing bolt . . . . .	188349	188349
§ Catch, rim fixing . . . . .	509936	509936
Spring, rim catch . . . . .	509191	509191
§ Bolt, lamp fixing . . . . .	503014	503014

### M, MB and MBD150 Dipping (Double Filament) and Non-dip Models

Part No. . . . .	†50284A MBD150 Chromium (50523)	‡50316A MBD150S Chromium —	‡50317A MBD150S Chromium —	†50337A M150 Black, C.P.R. (50441)	‡50338A M150 Black, C.P.R. —	†50339A M150 Black, C.P.R. —	†50345A MB150 Chromium (50753)
§Rim or door . . . . .	551075	551075	551075	551075	551075	551075	551075
§ Glass . . . . .	551070	551070	551070	510770	510770	510770	505975
§ Wires, glass fixing . . . . .	500291	500291	500291	500291	500291	500291	500291
§ Bead, rubber . . . . .	507088	507088	507088	507088	507088	507088	507088
§ Reflector . . . . .	507002	507002	507002	*506998	507002	507002	*506998
§ Bulb holder . . . . .	504801	504801	504801	504804	504801	504801	504804
§ Sleeve, terminal . . . . .	555910	555910	555910	555910	555910	555910	555910
Clip and screw, bulb holder clamp- ing . . . . .	551807	551807	551807	551807	551807	551807	551807
§ Bulb, 12 volt . . . . .	171	171	171	57	171	171	57
Nut, fixing bolt . . . . .	180377	503053	503053	180377	180377	180377	180377
Washer, fixing bolt . . . . .	188349	188349	188349	188349	188349	188349	188349
§ Catch, rim fixing . . . . .	509936	509936	509936	509936	509936	509936	509936
Spring, rim catch . . . . .	509191	509191	509191	509191	509191	509191	509191
§ Bolt, lamp fixing . . . . .	503014	503014	503014	503014	503014	503014	503014

For illustrations, see pages G7-G8

Note. For replacement lamp spare parts, see appropriate column under part number C.P.R. . . Chromium plated rim \* See Supersession Chart  
 † When ordering, quote part number shown in brackets ‡ Complete lamp no longer available; return unit for possible repair § Recommended spares for stock †† Pilot

# HEADLAMPS, External Fitting

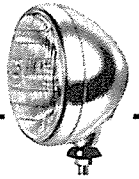

## DETAILED SPARE PARTS

### MD and MBD148 Dipping (Double Filament) and Non-dip Models—continued

50434A MD148P Black, C.P.R. —	50473A MBD148 Chromium —	†50475A MBD148 Chromium (50473)	50476A MBD148 Chromium —	†50623A MBD148 Chromium (50473)	50654A MBD148 Chromium —	†50741A MBD148S Chromium —	†50742A MBD148S Chromium —	†50743A MBD148S Chromium —
507577	507577	507577	507577	507577	507577	507577	507577	507577 (1)
507586	507586	507586	507586	507586	507586	507586	507586	507586 (2)
500291	500291	500291	500291	500291	500291	500291	500291	500291 (3)
509201	509201	509201	509201	509201	509201	509201	509201	509201 (4)
551912	506854	506854	506855	506854	506855	506855	506854	506855 (5)
504804	504804	504804	504801	504804	504801	504801	504804	504801 (6)
555910	555910	555910	555910	555910	555910	555910	555910	555910 (7)
—	551807	551807	551807	551807	551807	551807	551807	551807 (8)
57 †207	57	57	171	57	171	171	57	171 (9)
180377	—	—	—	180377	180377	503053	503053	503053 (10)
188349	—	—	—	188349	188349	188349	188349	188349 (11)
509936	509936	509936	509936	509936	509936	509936	509936	509936 (12)
509191	509191	509191	509191	509191	509191	509191	509191	509191 (13)
503014	503014	503014	503014	503014	503014	503014	503014	503014 (14)

### MBD163 Dipping (Double Filament) and Non-dip Models

Part No. . . . .	50541B MBD 163-1 Chromium	50542B MBD 163-1 Chromium	50543B MBD 163-1 Chromium
Replaced by (see footnote)	—	—	—
§Rim or door . . . . .	508718	508718	508718
§ Glass . . . . .	508724	508724	508724
§ Wires, glass fixing . . . . .	500291	500291	500291
§Bead, rubber . . . . .	507154	507154	507154
§Reflector . . . . .	508755	*507292	*507292
§ Bulb holder . . . . .	504804	504801	504801
§ Sleeve, terminal . . . . .	555910	555910	555910
§ Clip and screw, bulb holder clamping . . . . .	551807	551807	551807
§Bulb, 12 volt . . . . .	57	171	171
Nut, fixing bolt . . . . .	180377	180377	180377
Washer, fixing bolt . . . . .	188349	188349	188349
§Catch, rim fixing . . . . .	509936	509936	509936
Spring, rim catch . . . . .	509191	509191	509191
§Bolt, lamp fixing . . . . .	503970	503970	503970

### MBD163-EDS Dipping Reflector Models

Part No. . . . .	50540B MBD163-1EDS Chromium
Replaced by (see footnote)	—
§Rim or door . . . . .	508718
§ Glass . . . . .	508724
§ Wires, glass fixing . . . . .	500291
§Bead, rubber . . . . .	507154
§Reflector . . . . .	501875
§ Bulb holder, main . . . . .	504804
§ Sleeve, terminal . . . . .	555910
§ Clip and screw, bulb holder clamping . . . . .	551807
§Bulb, 12 volt . . . . .	57
§Dipper unit . . . . .	57017
§ Fuse . . . . .	188232
Nut, fixing bolt . . . . .	180377
Washer, fixing bolt . . . . .	188349
§Catch, rim fixing . . . . .	509936
Spring, rim catch . . . . .	509191
§Screw, lamp fixing . . . . .	503970

### MBD166-EDS Dipping Reflector Models

Part No. . . . .	†50150D MBD 166S-EDS Chromium	†50181A MBD 166S-EDS Chromium	50289D MBD 166S-EDS Chromium	†50325B MBD 166S-EDS Chromium	†50330D MBD 166S-EDS Chromium	†50600B MBD 166S-EDS Chromium	†50861A MBD 166-EDS Chromium	†506096 LBD 166-2EDS Chromium
Replaced by (see footnote)	—	—	—	—	—	—	—	—
§Rim or door . . . . .	508718	508718	508718	508718	508718	508718	508718	508718
§ Glass . . . . .	507163	507163	507163	507163	508724	508724	508724	507163
§ Wires, glass fixing . . . . .	500291	500291	500291	500291	500291	500291	500291	500291
§Bead, rubber . . . . .	507154	†508736	507154	507154	507154	507154	507154	†508736
§Reflector . . . . .	501875	501875	501875	501875	501875	501875	501875	—
§ Bulb holder . . . . .	504804	504804	504804	504804	504804	504804	504804	504804
§ Sleeve, terminal . . . . .	555910	555910	555910	555910	555910	555910	555910	555910
§ Clip and screw, bulb holder clamping . . . . .	551807	551807	551807	551807	551807	551807	551807	551807
§Bulb, main, 12 volt . . . . .	57	57	57	57	57	57	57	57
§Dipper unit . . . . .	57017	57017	57017	57017	57017	57017	57017	57017
§ Fuse . . . . .	188232	188232	188232	188232	188232	188232	188232	188232
Nut, fixing bolt . . . . .	—	—	—	503053	503053	180377	180377	180377
Washer, fixing bolt . . . . .	—	—	—	188349	188349	188349	188349	188349
§Catch, rim fixing . . . . .	509936	509936	509936	509936	509936	509936	509936	532590
Spring, rim catch . . . . .	509191	509191	509191	509191	509191	509191	509191	—
§Bolt, lamp fixing . . . . .	503014	503014	503014	503014	503014	503014	503014	—

For illustrations, see pages G7-G8

Note. For replacement lamp spare parts, see appropriate column under part number C.P.R. . . Chromium plated rim \* See Supersession Chart † Complete lamp no longer available; return old unit for possible repair ‡ Recommended spares for stock †† Pilot ††† Langite



# HEADLAMPS, External Fitting

## DETAILED SPARE PARTS

### LBD and MBD166 Dipping (Double Filament) and Non-dip Models

Part No. . . . .	‡50151B MBD 166S	‡50178A LBD 166	‡50182A MBD 166	50203A/D MBD 166-1S	50273A/D MBD 166-1S	‡50326B MBD 166S	‡50331D MBD 166S	50349B MBD 166S	‡50385B MBD 166S
Model . . . . .	Chromium	Chromium	Chromium	Chromium	Chromium	Chromium	Chromium	Chromium	Chromium
Finish . . . . .	—								
Replaced by (see footnote)	—								
(1) §Rim or door . . . . .	508718	508718	508718	508718	508718	508718	508718	508718	508718
(2) §Glass . . . . .	507163	507163	507163	508724	508724	507163	508724	507163	507163
(3) § Wires, glass fixing . . . . .	500291	500291	500291	500291	500291	500291	500291	500291	500291
(4) §Bead, rubber . . . . .	507154	508736	508736	507154	507154	507154	507154	507154	507154
(5) §Reflector . . . . .	508755	—	—	508755	*507292	508755	508755	*507292	*508762
(6) § Bulb holder . . . . .	504804	504804	504804	504804	504801	504804	504804	504801	504801
(7) § Sleeve, terminal . . . . .	555910	555910	555910	555910	555910	555910	555910	555910	555910
(8) Clip and screw, bulb holder clamping . . . . .	551807	551807	551807	551807	551807	551807	551807	551807	551807
(9) §Bulb, 12 volt . . . . .	57	57	57	57	171	57	57	171	171
(10) Nut, fixing bolt . . . . .	—	533537	—	533537	533537	503053	180377	503053	—
(11) Washer, fixing bolt . . . . .	—	188349	—	188349	188349	188349	188349	188349	—
(12) §Catch, rim fixing . . . . .	509936	509936	509936	509936	509936	509936	509936	509936	509936
(13) Spring, rim catch . . . . .	509191	509191	509191	509191	509191	509191	509191	509191	509191
(14) §Bolt, lamp fixing . . . . .	503014	503014	503014	504177	504177	503014	503014	503014	503014

### S700 Dipping (Double Filament) Models

Part No. . . . .	†50728D S700	†A50728D S700	†B50728D S700	†50729D S700	†50775E S700	†50798D S700	†50821D S700	†A50821D S700
Model . . . . .	Black, C.P.R.							
Finish . . . . .	Black, C.P.R.		Black, C.P.R.		Chromium		Chromium	
Replaced by (see footnote)	(51026)		(50873)		(51018)		(51026)	
(1) §Rim or door . . . . .	553248	553248	553248	553248	553248	553248	553248	553248
(2) § Wires, light unit fixing . . . . .	504665	504665	504665	504665	504665	504665	504665	504665
(3) §Light unit . . . . .	553759	553759	553759	553759	555447	553759	553759	553759
(4) §Bulb holder, main . . . . .	860895	860895	860895	554607	554607	554607	554602	554602
(5) § Sleeve, terminal . . . . .	555910	555910	555910	555910	555910	555910	555910	555910
(6) Clip and screw, bulb holder clamping . . . . .	—	—	—	—	—	—	—	—
(7) §Bulb holder, pilot . . . . .	—	—	—	—	—	—	—	—
(8) §Bulb, 12 volt . . . . .	354	355	370	325	355	325	354	355
(9) §Bulb, 6 volt . . . . .	—	—	—	—	—	—	—	—
(10) Nut, fixing bolt . . . . .	180364	180364	180364	180364	180377	180377	180377	180377
(11) Washer, fixing bolt . . . . .	188349	188349	188349	188349	188349	188349	188349	188349
(12) §Screw, rim fixing . . . . .	144921	144921	144921	144921	144921	144921	144921	144921
(13) Plate, rim fixing . . . . .	534296	534296	534296	534296	534296	534296	534296	534296
(14) §Bolt, lamp fixing . . . . .	503014	503014	503014	503014	503014	503014	503014	503014

### S700—continued

Part No. . . . .	†50876B S700EF	50877B S700	†50895B S700	†A50895B S700	†B50895B S700	†50896B S700	50897B S700	†50914B S700
Model . . . . .	Black, C.P.R.							
Finish . . . . .	Chromium		Black, C.P.R.		Black, C.P.R.		Chromium	
Replaced by (see footnote)	(50987)		(51026)		(51027)		(51029)	
(1) §Rim or door . . . . .	553248	553248	553248	553248	553248	553248	553248	553248
(2) § Wires, light unit fixing . . . . .	504665	504665	504665	504665	504665	504665	504665	504665
(3) §Light unit . . . . .	553948	555447	553759	553759	553759	553759	—	553759
(4) §Bulb holder, main . . . . .	562303	554602	860895	860895	860895	554607	553724	554602
(5) § Sleeve, terminal . . . . .	555910	555910	555910	555910	555910	555910	555910	555910
(6) Clip and screw, bulb holder clamping . . . . .	562306	—	—	—	—	—	—	—
(7) §Bulb holder, pilot . . . . .	†552943	—	—	—	—	—	—	—
(8) §Bulb, 12 volt . . . . .	—	355	302	303	370	185	—	354
(9) §Bulb, 6 volt . . . . .	—	—	—	—	—	—	—	—
(10) Nut, fixing bolt . . . . .	180377	180377	180364	180364	180364	180364	180377	180377
(11) Washer, fixing bolt . . . . .	188349	188349	188349	188349	188349	188349	188349	188349
(12) §Screw, rim fixing . . . . .	144921	144921	144921	144921	144921	144921	144921	144921
(13) Plate, rim catch . . . . .	534296	534296	534296	534296	534296	534296	534296	534296
(14) §Bolt, lamp fixing . . . . .	503014	503014	503014	503014	503014	503014	503014	503014

For illustrations, see pages G7-G8

Note. For replacement lamp spare parts, see appropriate column under part number \* See Supersession Chart † When ordering, quote part number shown in brackets ‡ Complete lamp no longer available; return old unit for possible repair § Recommended spares for stock † Langite \* Backshell C.P.R. . . Chromium plated rim

# HEADLAMPS, External Fitting

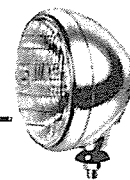

## DETAILED SPARE PARTS

### LBD and MBD166 Dipping (Double Filament) and Non-dip Models—continued

50530B MBD 166-2S Chromium	‡50531B MBD 166-2S Chromium	‡50554B MBD 166S Chromium	‡50580B MBD 166 Chromium	‡50581B MBD 166 Chromium	‡50601B MBD 166S Chromium	50655A MBD 166S Chromium	‡50656A MBD 166 Chromium	‡50657A MBD 166S Chromium	‡50862A MBD 166S Chromium	‡506097 LBD 166S Chromium
508718	508718	508718	508718	508718	508718	508718	508718	508718	508718	508718 (1)
508724	508724	508724	508724	508724	508724	508724	508724	508724	508724	507163 (2)
500291	500291	500291	500291	500291	500291	500291	500291	500291	500291	500291 (3)
507154	507154	507154	507154	507154	507154	507154	507154	507154	507154	508736 (4)
508755	508755	508755	*507292	*507292	501875	*507292	*507292	*507292	508755	508755 (5)
504804	504804	504804	504801	504801	504801	504801	504801	504801	504804	504804 (6)
555910	555910	555910	555910	555910	555910	555910	—	—	555910	555910 (7)
551807	551807	551807	551807	551807	551807	551807	551807	551807	551807	551807 (8)
57	57	57	171	171	57	171	171	171	57	57 (9)
180377	180377	—	180377	180377	180377	180377	180377	—	180377	180377 (10)
188349	188349	—	188349	188349	188349	188349	188349	—	188349	188349 (11)
509936	509936	509936	509936	509936	509936	509936	509936	509936	509936	532590 (12)
509191	509191	509191	509191	509191	509191	509191	509191	509191	509191	— (13)
—	—	503014	503014	503014	503014	—	—	503014	503014	— (14)

### S700 Dipping (Double Filament) Models—continued

‡B50821D S700 Chromium (50986)	‡50854D S700 Black, C.P.R. (51023)	‡A50854D S700 Black, C.P.R. (51025)	‡B50854D S700 Black, C.P.R. (51024)	‡50855B S700 Black, C.P.R. (51023)	‡50869D S700 Chromium (50988)	‡A50869D S700 Chromium (50877)	‡B50869D S700 Chromium (50986)	‡50870D S700 Chromium (50988)	50873A/B S700 Chromium —
553248	553248	553248	553248	553248	553248	553248	553248	553248	553248 (1)
504665	504665	504665	504665	504665	504665	504665	504665	504665	504665 (2)
553759	553759	553759	553759	553759	553759	553759	553759	553759	555447 (3)
554602	554602	554602	554602	554607	554602	554602	554602	554602	554602 (4)
555910	555910	555910	555910	555910	555910	555910	555910	555910	555910 (5)
—	—	—	—	—	—	—	—	—	— (6)
—	—	—	—	—	—	—	—	—	— (7)
370	354	355	370	325	354	355	370	325	355 (8)
—	—	—	—	—	—	—	—	—	— (9)
180377	180377	180377	180377	180377	180377	180377	180377	180377	180364 (10)
188349	188349	188349	188349	188349	188349	188349	188349	188349	188349 (11)
144921	144921	144921	144921	144921	144921	144921	144921	144921	144921 (12)
534296	534296	534296	534296	534296	534296	534296	534296	534296	534296 (13)
503014	503014	503014	503014	503014	503014	503014	503014	503014	503014 (14)

### S700—continued

‡50915B S700 Black, C.P.R. (51029)	§50947A SS700P Black, C.P.R. —	‡50985A S700 Chromium (50988)	50986A S700 Chromium —	50987A S700EF Chromium —	50988A S700 Chromium —	‡50989A S700 Chromium (50877)	‡50990A S700 Chromium (50987)	‡50991A S700EF Chromium (51651)
553248	553248	553248	553248	553248	553248	553248	553248	553248 (1)
504665	504665	504665	504665	504665	504665	504665	504665	504665 (2)
553759	*553268	553921	553940	553948	553921	555447	553940	553948 (3)
554607	555009	554602	554602	562303	554602	554602	554602	562303 (4)
555910	555910	555910	555910	555910	555910	555910	555910	555910 (5)
—	—	—	—	562306	—	—	—	562306 (6)
—	554710	—	—	*552943	—	—	—	*552943 (7)
325	—	354	370	—	354	301	370	— (8)
—	312 **988	—	—	—	—	—	—	— (9)
180377	112201	180377	180377	180377	180377	180377	180377	180377 (10)
188349	137141	188349	188349	188349	188349	188349	188349	188349 (11)
144921	144921	144921	144921	144921	144921	144921	144921	144921 (12)
534296	534296	534296	534296	534296	534296	534296	534296	534296 (13)
503014	—	503014	503014	503014	503014	503014	503014	503014 (14)

For illustrations, see pages G7-G8

Note. For replacement lamp spare parts, see appropriate column under part number. \* See Supersession Chart.  
 † When ordering, quote part number shown in brackets. ‡ Complete lamp no longer available; return old unit for possible repair. †† Langite. § SS700P Model.  
 ‡ Backshell. \*\* Pilot. C.P.R. ... Chromium plated rim.

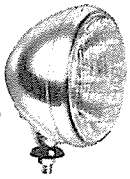

# HEADLAMPS, External Fitting

## DETAILED SPARE PARTS

### S700 and SS575 Dipping (Double Filament) Models

Part No. . . . .	†50995A S700	†50996A S700	†51014A/F S700 Black, C.P.R. (51023)	†51015A/F S700 Black, C.P.R. (51024)	†51016A/F S700 Black, C.P.R. (51025)	†51017A S700 Black, C.P.R. (51026)	51018A S700 Black, C.P.R. (51027)	51023E S700 Black, C.P.R. —
Model . . . . .	Chromium	Chromium	Black, C.P.R. (51023)	Black, C.P.R. (51024)	Black, C.P.R. (51025)	Black, C.P.R. (51026)	Black, C.P.R. (51027)	Black, C.P.R. —
Finish . . . . .								
Replaced by (see footnote) . . . . .	(50988)	(50986)	(51023)	(51024)	(51025)	(51026)	(51027)	—
§Rim or door . . . . .	553248	553248	553248	553248	553248	553248	553248	553248
§ Wires, light unit fixing . . . . .	504665	504665	504665	504665	504665	504665	504665	504665
§Light unit . . . . .	553921	553940	553921	553940	555447	553921	553940	553921
§Bulb holder, main . . . . .	554602	554602	554602	554602	554602	554602	554602	554602
§ Sleeve, terminal . . . . .	555910	555910	555910	555910	555910	555910	555910	555910
§Bulb, 12 volt . . . . .	354	370	354	370	355	354	370	354
§Bulb, 6 volt . . . . .	—	—	—	—	—	—	—	—
Nut, fixing bolt . . . . .	180377	180377	180377	180377	180377	180364	180364	180377
Washer, fixing bolt . . . . .	188349	188349	188349	188349	188349	188349	188349	188349
§Screw, rim fixing . . . . .	144921	144921	144921	144921	144921	144921	144921	144921
Plate, rim fixing . . . . .	534296	534296	534296	534296	534296	534296	534296	534296
§Bolt, lamp fixing . . . . .	503014	503014	503014	503014	503014	503014	503014	503014

### S700 and SS575—continued

Part No. . . . .	51024E S700 Black, C.P.R. —	51025F S700 Black, C.P.R. —	51026A S700 Black, C.P.R. —	51027A S700 Black, C.P.R. —	51029A S700 Black, C.P.R. —	51076A SS575 Black, C.P.R. —	†51078E S700 Black, C.P.R. (51023)	†51079E S700 Black, C.P.R. (51024)	†51080E S700 Black, C.P.R. (51025)
Model . . . . .									
Finish . . . . .									
Replaced by (see footnote) . . . . .	—	—	—	—	—	—	(51023)	(51024)	(51025)
§Rim or door . . . . .	553248	553248	553248	553248	553248	553248	553248	553248	553248
§ Wires, light unit fixing . . . . .	504665	504665	504665	504665	504665	504665	504665	504665	504665
§Light unit . . . . .	553940	555447	553921	553940	553921	553695	553921	553940	555447
§Bulb holder, main . . . . .	554602	554602	554602	554602	554602	554602	554602	554602	554602
§ Sleeve, terminal . . . . .	555910	555910	555910	555910	555910	555910	555910	555910	555910
§Bulb, 12 volt . . . . .	370	355	354	370	354	—	354	370	355
§Bulb, 6 volt . . . . .	—	—	—	—	—	166	—	—	—
Nut, fixing bolt . . . . .	180377	180377	180364	180364	180377	112201	180377	180377	180377
Washer, fixing bolt . . . . .	188349	188349	188349	188349	188349	137141	188349	188349	188349
§Screw, rim fixing . . . . .	144921	144921	144921	144921	144921	144921	144921	144921	144921
Plate, rim fixing . . . . .	534296	534296	534296	534296	534296	534296	534296	534296	534296
§Bolt, lamp fixing . . . . .	503014	503014	503014	503014	503014	—	503014	503014	503014

### S700 and SS575—continued

Part No. . . . .	†51353A S700 Black, C.P.R. (51023)	†51354A S700 Black, C.P.R. (51027)	51355A S700 Black, C.P.R. (50873)	51405A S700 Grey, C.P.R. —	51651A S700EF Chromium —	51682A S700 Black, C.P.R. —	51906A SS700 Black, C.P.R. —	58295A S700 C.P.R. —	58464A S700 Black, C.P.R. —
Model . . . . .									
Finish . . . . .									
Replaced by (see footnote) . . . . .	(51023)	(51027)	(50873)	—	—	—	—	—	—
§Rim or door . . . . .	553248	553248	553248	553248	553248	553248	553248	553248	553248
§ Screw, rim fixing . . . . .	—	—	—	—	—	—	—	144921	—
§ Wires, light unit fixing . . . . .	504665	504665	504665	504665	504665	504665	504665	504665	504665
§Light unit . . . . .	553921	553940	555447	554842	553948	—	553925	556452	54520148
§Plate, light unit retaining . . . . .	—	—	—	—	—	—	—	—	—
§Spring, light unit fixing . . . . .	—	—	—	—	—	—	—	—	—
§Bulb holder, main . . . . .	554602	554602	554602	554607	562303	553724	554602	553738	553738
§ Sleeve, terminal . . . . .	555910	555910	555910	555910	555910	555910	555910	555910	555910
Clip and screw, bulb holder clamping . . . . .	—	—	—	—	562306	—	—	—	‡556442
§Bulb holder, pilot . . . . .	—	—	—	—	‡552943	—	—	—	—
§Bulb, 12 volt . . . . .	354	370	355	325	—	—	311	410	410
§Bulb, 6 volt . . . . .	—	—	—	—	—	—	—	—	—
Nut, fixing bolt . . . . .	180377	180377	180377	180377	180377	180377	—	180377	180377
Washer, fixing bolt . . . . .	188349	188349	188349	188349	188349	188349	137499	188349	188349
§Screw, rim fixing . . . . .	144921	144921	144921	144921	144921	144921	144921	—	144921
Plate, rim fixing . . . . .	534296	534296	534296	534296	534296	534296	534296	534296	534296
§Bolt, lamp fixing . . . . .	503014	503014	503014	503014	503014	503014	112201	503014	503014
Clip, cable . . . . .	—	—	—	—	—	—	—	552335	552335
Screw, cable clip . . . . .	—	—	—	—	—	—	—	186181	—

For illustrations, see pages G7–G8

Note. For replacement lamp spare parts, see appropriate column under part number  
 ‡ Bulb retaining spring § Recommended spares for stock || Backshell

† When ordering, quote part number shown in brackets  
 C.P.R. . . . Chromium plated rim

continued



# HEADLAMPS, Flush Fitting

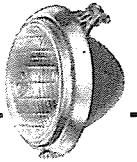

## Models:

F575, F700, P700, PF700, RF700,  
PF770, MCF575, RL700 and PL700

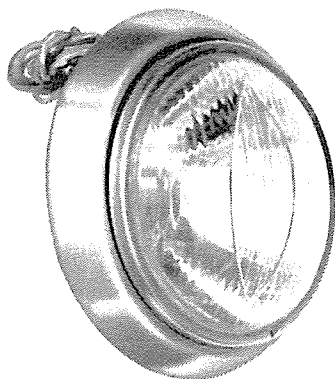

MODEL F575  
MCF575 (less  
body)



MODEL F700

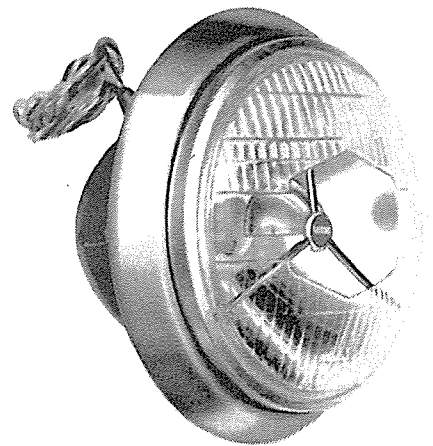

MODEL P700

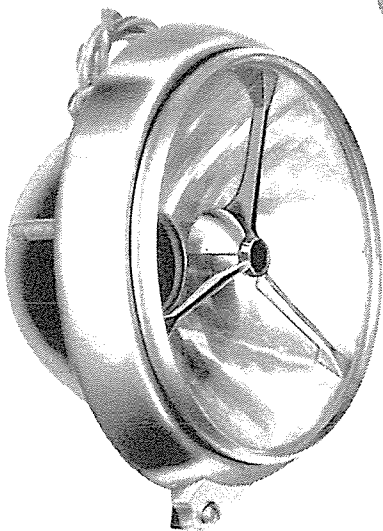

MODEL PF770

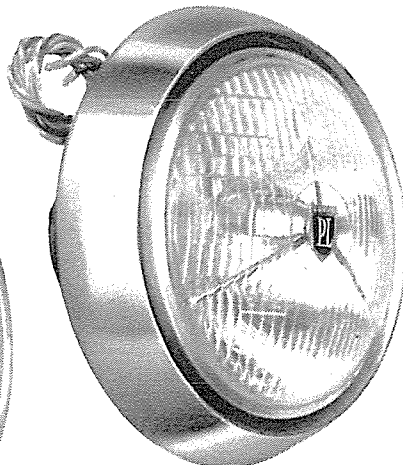

MODEL PL700  
RL700 (R.R.  
Motif)



MODEL PF700  
RF700

*For detailed spare parts, see pages G30-G68*



# HEADLAMPS, Flush Fitting

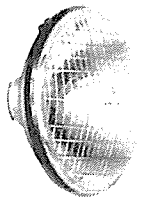

516659 (Non-Pilot)  
516828 (Pilot-Bottom)  
553695 (Non-Pilot)  
553700 (Pilot-Top)

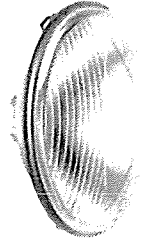

552495 (F575)  
552496 (F575P)  
552849 (F575P-3 pin)  
553759 (F700)  
556075 (F700P)

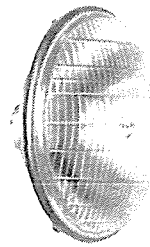

553564 (Pilot)  
553921  
554496  
555306  
555309 (Pilot)  
555447  
555991  
556376 (Pilot)  
556597 (Pilot)  
54520132 (Pilot)  
54520136

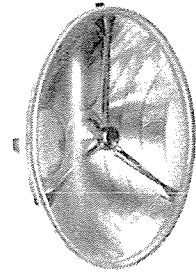

553476 (Bentley Biflex)  
553627 (R.R. Biflex)  
553961 (Lucas Marking)  
553982 (Austin 'A')

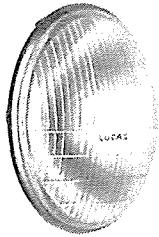

553940  
553948 (3 Pin)  
554253 (Pilot-3 Pin)  
555275 (Pilot)  
555305 (Vert Dip with Adaptor)  
556288 (Pilot)  
54520882

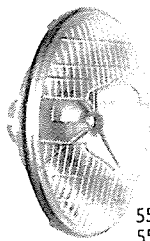

554308  
555296  
555996  
556229  
554999 (Special Adaptor)



554430

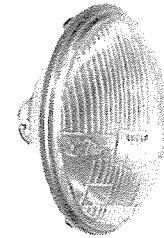

554665 (Le Mans)  
555288 (Le Mans 3 Pin)

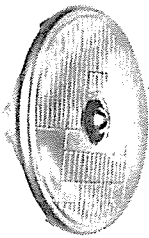

554917  
555355 (3 Pin)

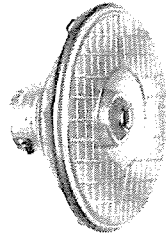

555709  
555710

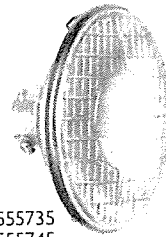

555735  
555745  
54520067 (Special Adaptor)  
54520068 (Special Adaptor)



555752  
555753 (Austin 'A')  
555754  
556565  
556566 (Lucas Marking)  
556567

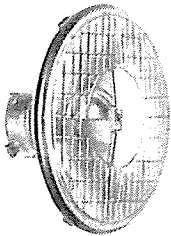

555423 ('B' Medallion)  
555424 ('B' Medallion)  
555998 (R.R. Medallion)  
555999 (R.R. Medallion)

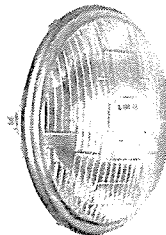

556452  
54520883

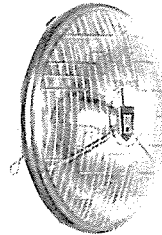

556599  
54520293

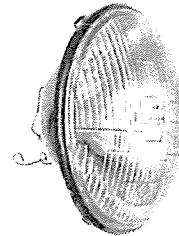

54520148 (Sweden)  
54520420 (Pilot)



54521060

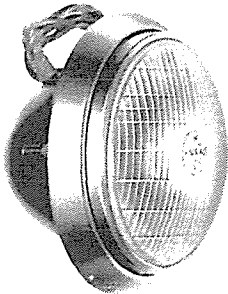

MODEL F700

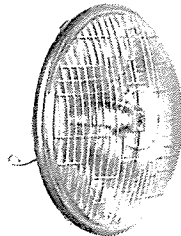

556379 (R.R. Medallion)  
556380 ('B' Medallion)  
54520275 (R.R. Medallion)  
54520276 ('B' Medallion)

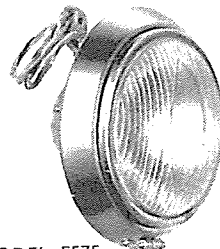

MODEL F575  
MCF575P (Less Body)

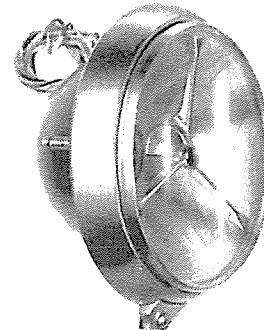

MODEL PF770  
RF770

For detailed spare parts, see pages G30-G68

# HEADLAMPS, Flush Fitting

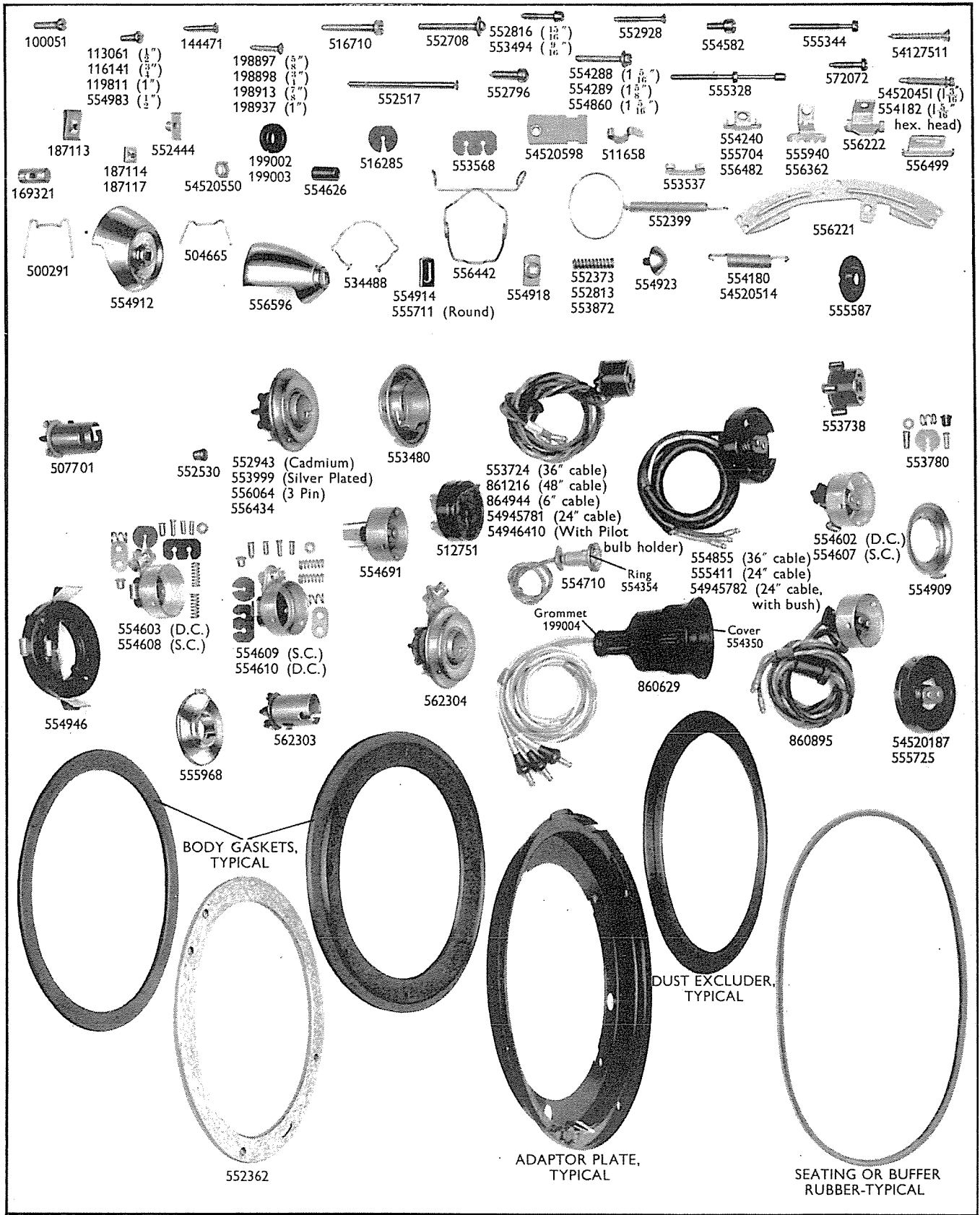

For detailed spare parts, see pages G30-G68



# HEADLAMPS, Flush Fitting



For detailed spare parts, see pages G30-G68

# HEADLAMPS, Flush Fitting



556353

556420  
556027 (With fixing brackets)  
54520810

556429

556432

556498

Embellisher  
556503

556511

556537

556563  
54520122 (Smaller side lamp aperture)

54520154

54520673

## PLATES, LIGHT UNIT RETAINING

554463 (Olive finish)

552686

552704  
552392 (F700)  
553614 (with spring box)

553715

553717

552805 (F575)  
554872 (F700)  
554893 (F700)  
555351 (R.R.)

553877 (PF770)  
553972 (PF770)  
554907 (J700)  
552970 (With spring box)

553878 (7 1/4" Aperture)  
553971 (6 3/8" Aperture)  
554906 (6 11/16" Aperture)

554345

554596

554871 (3 slots)  
554672 (6 slots)

54520446  
554175

54520549  
554179 (Slotted)

For detailed spare parts, see pages G30-G68

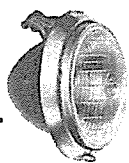

# HEADLAMPS, Flush Fitting

## DETAILED SPARE PARTS

Part No. . . . .		†50144A	*A50144A	†50165A	†50166A	†50262A	†A50262A	†B50262A	†50263A
Model . . . . .		F700	F700	F700P	F700P	F700	F700	F700	F700
Finish . . . . .		C.P.R.	C.P.R.	C.P.R.	C.P.R.	C.P.R.	C.P.R.	C.P.R.	C.P.R.
Replaced by (see footnote) . . . . .		(50882)	—	(51369)	(51369)	(51344)	(51533)	(51346)	(51344)
(1) §Rim or door . . . . .		552406	552406	552406	552406	552405	552405	552405	552405
(2) § Screw, rim fixing . . . . .		—	—	—	—	—	—	—	—
(3) Motif, top front . . . . .		—	—	—	—	—	—	—	—
(4) Screw, bracket and motif fixing . . . . .		—	—	—	—	—	—	—	—
(5) Bracket, rim and motif fixing . . . . .		—	—	—	—	—	—	—	—
(6) §Excluder, dust . . . . .		—	—	—	—	—	—	—	—
(7) §Plate, light unit retaining . . . . .		552371	552371	552371	552371	552371	552371	552371	552371
(8) Screw, unit rim . . . . .		—	—	—	—	—	—	—	—
(9) Rim, unit seating . . . . .		552392	552392	552392	552392	—	—	—	—
(10) Piece, packing . . . . .		—	—	552362	552362	552362	552362	552362	552362
(11) §Light unit . . . . .		553759	553759	556075	556075	553759	553759	553759	553759
(12) Spring, light unit fixing . . . . .		—	—	—	—	—	—	—	—
(13) Screw, plate fixing . . . . .		—	—	—	—	—	—	—	—
(14) Screw, pivot . . . . .		100329	100329	100329	100329	100329	100329	100329	100329
(15) Pivot . . . . .		552444	552444	552444	552444	552444	552444	552444	552444
(16) §Bulb holder . . . . .		554602	554602	554603	554608	554602	554602	554602	554607
(17) § Sleeve, terminal . . . . .		555910	555910	555910	555910	555910	555910	555910	555910
(18) § Interior, pilot bulb holder . . . . .		—	—	553780	553780	—	—	—	—
(19) §Backshell . . . . .		—	—	—	—	—	—	—	—
(20) Clip and screw, adaptor . . . . .		—	—	—	—	—	—	—	—
(21) §Bulb, main . . . . .		354	355	354 ‡222	162 ‡222	354	355	370	162
(22) §Buffer, rubber . . . . .		—	—	—	—	—	—	—	—
(23) Conversion adaptor . . . . .		—	—	—	—	—	—	—	—
(24) §Gasket, rubber . . . . .		—	—	—	—	553760	553760	553760	553760
(25) Screw, with washer . . . . .		554288	554288	554288	554288	554288	554288	554288	554288
(26) Spring, trimmer . . . . .		552399	552399	552399	552399	552399	552399	552399	552399
(27) Screw, motif fixing . . . . .		—	—	—	—	—	—	—	—
(28) Washer, spring . . . . .		—	—	—	—	—	—	—	—
(29) Sleeve, sealing . . . . .		—	—	—	—	—	—	—	—
(30) Screw, body fixing . . . . .		—	—	—	—	—	—	—	—

Part No. . . . .		†50446K	†50528M	50529B	A50529B	B50529B	†50537B	†50550E	†A50550E
Model . . . . .		F700	F700	F575P-1	F575P-1	F575P-1	F575P-1	F700P	F700P
Finish . . . . .		C.P.R.	C.P.R.	C.P.R.	C.P.R.	C.P.R.	C.P.R.	C.P.R.	C.P.R.
Replaced by (see footnote) . . . . .		(51336)	(51533)	—	—	—	(50529)	(51592)	(50605)
(1) §Rim or door . . . . .		552913	552912	552529	552529	552529	552529	552949	552949
(2) § Screw, rim fixing . . . . .		552816	552816	—	—	—	—	552816	552816
(3) Motif, top front . . . . .		—	—	—	—	—	—	—	—
(4) Screw, bracket and motif fixing . . . . .		—	—	—	—	—	—	—	—
(5) Bracket, rim and motif fixing . . . . .		—	—	—	—	—	—	—	—
(6) §Excluder, dust . . . . .		552906	552906	—	—	—	—	552906	552906
(7) §Plate, light unit retaining . . . . .		554872	554872	—	—	—	—	554872	554872
(8) Screw, unit rim . . . . .		186137	186137	—	—	—	—	186137	186137
(9) Rim, unit seating . . . . .		554871	554871	—	—	—	—	554871	554871
(10) Piece, packing . . . . .		553537	553537	—	—	—	—	553537	553537
(11) §Light unit . . . . .		553759	555447	552496	552496	552496	552496	556075	556075
(12) Spring, light unit fixing . . . . .		—	—	504665	504665	504665	504665	—	—
(13) Screw, plate fixing . . . . .		—	—	552517	552517	552517	552517	—	—
(14) Screw, pivot . . . . .		—	—	—	—	—	—	—	—
(15) Pivot . . . . .		—	—	—	—	—	—	—	—
(16) §Bulb holder . . . . .		554607	554602	554610	554610	554610	554610	554603	554603
(17) § Sleeve, terminal . . . . .		555910	555910	555910	555910	555910	555910	555910	555910
(18) § Interior, pilot bulb holder . . . . .		—	—	553780	553780	553780	553780	553780	553780
(19) §Backshell . . . . .		—	—	—	—	—	—	—	—
(20) Clip and screw, adaptor . . . . .		—	—	—	—	—	—	—	—
(21) §Bulb, main . . . . .		325	355	354 ‡222	355 ‡222	370 ‡222	162 ‡222	354 ‡222	355 ‡222
(22) §Buffer, rubber . . . . .		—	—	—	—	—	—	—	—
(23) Conversion adaptor . . . . .		—	—	—	—	—	—	—	—
(24) §Gasket, rubber . . . . .		552915	553561	—	—	—	—	552996	552996
(25) Screw, with washer . . . . .		554288	554288	—	—	—	—	554288	554288
(26) Spring, trimmer . . . . .		552813	552813	512714	512714	512714	512714	552813	552813
(27) Screw, motif fixing . . . . .		—	—	—	—	—	—	—	—
(28) Washer, spring . . . . .		—	—	—	—	—	—	—	—
(29) Motif . . . . .		—	—	—	—	—	—	—	—
(30) Screw, body fixing . . . . .		—	—	—	—	—	—	—	—
(31) Pin, split . . . . .		—	—	186711	186711	186711	186711	—	—
(32) Nut, barrel . . . . .		—	—	169321	169321	169321	169321	—	—
(33) Bung, rubber, pivot . . . . .		—	—	552530	552530	552530	552530	—	—

For illustrations, see pages G25-G29

Note. For replacement lamp spare parts, see appropriate column under part number \* See Supersession Chart † When ordering, quote part number shown in brackets  
 ‡ Pilot § Recommended spares for stock C.P.R. . . . . Chromium plated rim

# HEADLAMPS, Flush Fitting

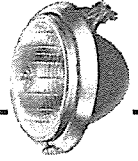

## DETAILED SPARE PARTS

†50264D F700 C.P.R. (50882)	†50311F RF770 Chromium (50751)	†50360B F575P C.P.R. (50613)	†A50360B F575P C.P.R. (A50613)	†50361A F575P C.P.R. (50613)	†50362F F700P C.P.R. (51592)	†50429H RF770 C.P.R. (50751)	†50444D F700 C.P.R. (50794)	†50445K F700 C.P.R. (51336)	†A50445K F700 C.P.R. (51509)	†B50445K F700 C.P.R. (51339)	
552406	552678	552822	552822	552822	552913	552678	552923	552913	552913	552913	(1)
—	552796	552816	552816	552816	552816	552796	552928	552816	552816	552816	(2)
—	552689	—	—	—	—	552689	—	—	—	—	(3)
—	116003	—	—	—	—	116003	—	—	—	—	(4)
—	552691	552817	552817	552817	—	552691	—	—	—	—	(5)
—	†552688	552806	552806	552806	552906	—	552906	552906	552906	552906	(6)
552371	552686	—	—	—	554872	552686	554872	554872	554872	554872	(7)
—	—	—	—	—	186137	—	186137	186137	186137	186137	(8)
552392	552704	552805	552805	552805	554871	552704	554871	554871	554871	554871	(9)
—	—	—	—	—	553537	—	553537	553537	553537	553537	(10)
553759	*552702	552496	552496	552496	556075	554736	556075	553759	553759	554759	(11)
—	552687	—	—	—	—	552687	—	—	—	—	(12)
—	101970	—	—	—	—	101970	—	—	—	—	(13)
100329	100329	—	—	—	—	100329	—	—	—	—	(14)
552444	552444	—	—	—	—	552444	—	—	—	—	(15)
554607	554607	554610	554610	554609	554608	554607	554608	554602	554602	554602	(16)
555910	555910	555910	555910	555910	555910	555910	555910	555910	555910	555910	(17)
—	—	553780	553780	553780	553780	—	—	—	—	—	(18)
—	—	—	—	—	—	553480	—	—	—	—	(19)
—	—	—	—	—	—	—	—	—	—	—	(20)
162	185	354 †222	355 †222	162 †222	162 †989	302	325	354	355	370	(21)
—	—	—	—	—	—	—	—	—	—	—	(22)
—	—	552823	552823	552823	552915	—	552922	552915	552915	552915	(24)
554288	554288	554288	554288	554288	554288	554288	554288	554288	554288	554288	(25)
552399	552399	552813	552813	552813	552813	554383	552813	552813	552813	552813	(26)
—	132504	—	—	—	—	132504	—	—	—	—	(27)
—	188412	—	—	—	—	188412	—	—	—	—	(28)
—	—	—	—	—	554626	—	554626	554626	554626	554626	(29)
—	117020	—	—	—	—	117020	—	—	—	—	(30)

†B50550E F700P C.P.R. (50983)	†50551E F700P C.P.R. (51592)	†50571D PF770 C.P.R. (50825)	50572F F575 C.P.R.	A50572F F575 C.P.R.	B50572F F575 C.P.R.	†50573F F575 C.P.R. (50792)	†50578E F575P C.P.R. (50613)	†50579K F700 C.P.R. (51344)	50605H F700 C.P.R.	†50612A F700 C.P.R. (51336)	
552949	552949	552792	552822	552822	552822	552822	552822	552912	552913	552913	(1)
552816	552816	552796	553494	553494	553494	553494	553494	552816	552816	552816	(2)
—	—	553979	—	—	—	—	—	—	—	—	(3)
—	—	116003	—	—	—	—	—	—	—	—	(4)
—	—	552691	—	—	—	—	—	—	—	—	(5)
552906	552906	—	552806	552806	552806	552806	552806	552906	552906	—	(6)
554872	554872	552686	552805	552805	552805	552805	552805	554872	554872	552392	(7)
186137	186137	—	—	—	—	—	—	186137	186137	552371	(8)
554871	554871	552704	—	—	—	—	—	554871	554871	—	(9)
553537	553537	—	—	—	—	—	—	553537	553537	552362	(10)
556075	556075	553961	552495	552495	552495	552495	552495	553759	553564	553759	(11)
—	—	552687	—	—	—	—	—	—	—	—	(12)
—	—	101970	—	—	—	—	—	—	—	101893	(13)
—	—	100329	—	—	—	—	—	—	—	100329	(14)
—	—	552444	—	—	—	—	—	—	—	552444	(15)
554603	554608	554607	554602	554602	554602	554607	554609	554607	554603	554607	(16)
555910	555910	555910	555910	555910	555910	555910	555910	555910	555910	555910	(17)
553780	553780	—	—	—	—	—	553780	—	553780	—	(18)
—	—	553480	—	—	—	—	—	—	—	—	(19)
—	—	—	—	—	—	—	—	—	—	—	(20)
370 †222	325 †222	185	354	355	370	325	325 †222	325	355 †222	354	(21)
—	—	—	—	—	—	—	—	—	—	—	(22)
—	—	—	—	—	—	—	—	—	—	—	(23)
552996	552996	552688	552823	552823	552823	552823	552823	553561	552915	—	(24)
554288	554288	554288	554288	554288	554288	554288	554288	554288	554288	554288	(25)
552813	552813	553483	552813	552813	552813	552813	552813	552813	552813	552399	(26)
—	—	132504	—	—	—	—	—	—	—	—	(27)
—	—	188412	—	—	—	—	—	—	—	—	(28)
—	—	552690	—	—	—	—	—	—	—	—	(29)
—	—	117020	—	—	—	—	—	—	—	—	(30)
—	—	—	—	—	—	—	—	—	—	—	(31)
—	—	—	—	—	—	—	—	—	—	—	(32)
—	—	—	—	—	—	—	—	—	—	—	(33)

For illustrations, see pages G25-G29

\* See Supersession Chart † When ordering, quote part number shown in brackets ‡ Gasket, rubber †† Pilot C.P.R. ... Chromium plated rim continued

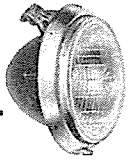

# HEADLAMPS, Flush Fitting

## DETAILED SPARE PARTS

Part No. . . . .	50613E	*A50613E	*B50613E	†50614E	50664E	50675E	50679E	†50694F
Model . . . . .	F575P	F575P	F575P	F575P	F575P-EF	F700P-EF	F700P-EF	F700
Finish . . . . .	C.P.R.	C.P.R.	C.P.R.	C.P.R.	C.P.R.	C.P.R.	C.P.R.	C.P.R.
Replaced by (see footnote) . . . . .	—	—	—	(50613)	—	—	—	(51336)
(1) §Rim or door . . . . .	552822	552822	552822	552822	552822	552923	552913	552913
(2) § Screw, rim fixing . . . . .	553494	553494	553494	553494	553494	552928	552816	552816
(3) Motif, top front . . . . .	—	—	—	—	—	—	—	—
(4) Screw, bracket and motif fixing . . . . .	—	—	—	—	—	—	—	—
(5) Bracket, rim and motif fixing . . . . .	—	—	—	—	—	—	—	—
(6) §Excluder, dust . . . . .	552806	552806	552806	552806	552806	552906	552906	552906
(7) §Plate, light unit retaining . . . . .	552805	552805	552805	552805	552805	554872	554872	554872
(8) Screw, unit rim . . . . .	—	—	—	—	—	186137	186137	186137
(9) Rim, unit seating . . . . .	—	—	—	—	—	554871	554871	554871
(10) Piece, packing . . . . .	—	—	—	—	—	553537	553537	553537
(11) §Light unit . . . . .	552495	552495	552495	552495	552849	554253	554253	553759
(12) Spring, light unit fixing . . . . .	—	—	—	—	—	—	—	—
(13) Screw, plate fixing . . . . .	—	—	—	—	—	—	—	—
(14) Screw, pivot . . . . .	—	—	—	—	—	—	—	—
(15) Pivot . . . . .	—	—	—	—	—	—	—	—
(16) §Bulb holder . . . . .	554610	554610	554610	554609	562303	562303	562303	554602
(17) § Sleeve, terminal . . . . .	555910	555910	555910	555910	555910	555910	555910	555910
(18) § Interior, pilot bulb holder . . . . .	553780	553780	553780	553780	553780	553780	553780	—
(19) §Backshell . . . . .	—	—	—	—	—	562304	562304	—
(20) Clip and screw, adaptor . . . . .	—	—	—	—	562306	562306	562306	—
(21) §Bulb, main . . . . .	354   222	355   222	370   222	325   222	222	222	222	354
(22) §Buffer, rubber . . . . .	—	—	—	—	—	—	—	—
(23) Conversion adaptor . . . . .	—	—	—	—	—	—	—	—
(24) §Gasket, rubber . . . . .	552823	552823	552823	552823	552823	552915	552915	552915
(25) Screw, with washer . . . . .	554288	554288	554288	554288	554288	554288	554288	554288
(26) Spring, trimmer . . . . .	552813	552813	552813	552813	552813	552813	552813	552813
(27) Screw, motif fixing . . . . .	—	—	—	—	—	—	—	—
(28) Washer, spring . . . . .	—	—	—	—	—	—	—	—
(29) Sleeve, sealing . . . . .	—	—	—	—	—	554626	554626	554626
(30) Screw, body fixing . . . . .	—	—	—	—	—	—	—	—

Part No. . . . .	†B50734D	†50735D	50747B/D	50751D	†50755E	†50756E	†A50756E	†B50756E
Model . . . . .	F700P	F700P	F700EF	RF770	F700P	F700P	F700P	F700P
Finish . . . . .	C.P.R.	C.P.R.	C.P.R.	C.P.R.	C.P.R.	C.P.R.	C.P.R.	C.P.R.
Replaced by (see footnote) . . . . .	(50983)	(50982)	—	—	(51369)	(51369)	(51370)	(51371)
(1) §Rim or door . . . . .	552913	552913	552936	552678	552936	552936	552936	552936
(2) § Screw, rim fixing . . . . .	552816	552816	552816	554582	552816	552816	552816	552816
(3) Motif, top front . . . . .	—	—	—	552689	—	—	—	—
(4) Screw, bracket and motif fixing . . . . .	—	—	—	116003	—	—	—	—
(5) Bracket, rim and motif fixing . . . . .	—	—	—	552691	—	—	—	—
(6) §Excluder, dust . . . . .	552906	552906	552906	—	552906	552906	552906	552906
(7) §Plate, light unit retaining . . . . .	554872	554872	554872	552686	554872	554872	554872	554872
(8) Screw, unit rim . . . . .	186137	186137	186137	101970	186137	186137	186137	186137
(9) Rim, unit seating . . . . .	554871	554871	554871	552704	554871	554871	554871	554871
(10) Piece, packing . . . . .	553537	553537	553537	—	553537	553537	553537	553537
(11) §Light unit . . . . .	556075	556075	553948	553476	556075	556075	556075	556075
(12) Spring, light unit fixing . . . . .	—	—	—	552687	—	—	—	—
(13) Screw, plate fixing . . . . .	—	—	—	—	—	—	—	—
(14) Screw, pivot . . . . .	—	—	—	100329	—	—	—	—
(15) Pivot . . . . .	—	—	—	552444	—	—	—	—
(16) §Bulb holder . . . . .	554603	554608	562303	554602	554608	554603	554603	554603
(17) § Sleeve, terminal . . . . .	555910	555910	555910	555910	555910	555910	555910	555910
(18) § Interior, pilot bulb holder . . . . .	553780	553780	—	—	553780	553780	553780	553780
(19) §Backshell . . . . .	—	—	†552943	553480	—	—	—	—
(20) Clip and screw, adaptor . . . . .	—	—	562306	—	—	—	—	—
(21) §Bulb, main . . . . .	370   222	325   222	—	302	325   222	354   222	355   222	370   222
(22) §Buffer, rubber . . . . .	—	—	—	—	—	—	—	—
(23) Conversion adaptor . . . . .	—	—	—	—	—	—	—	—
(24) §Gasket, rubber . . . . .	552915	552915	553561	552688	553561	553561	553561	553561
(25) Screw, with washer . . . . .	554288	554288	554289	554288	554288	554288	554288	554288
(26) Spring, trimmer . . . . .	552813	552813	552813	553483	552813	552813	552813	552813
(27) Screw, clamp . . . . .	—	—	—	—	—	—	—	—
(28) Ring, fixing . . . . .	—	—	552970	—	—	—	—	—
(29) Sleeve, sealing . . . . .	554626	554626	554626	—	554626	554626	554626	554626
(30) Screw, body fixing . . . . .	—	—	—	117020	—	—	—	—

For illustrations, see pages G25–G29

Note. For replacement lamp spare parts, see appropriate column under part number \* See Supersession Chart † When ordering, quote part number shown in brackets  
 ‡ Supplied complete with Adaptor 562303 § Recommended spares for stock || Pilot C.P.R. . . Chromium plated rim



# HEADLAMPS, Flush Fitting

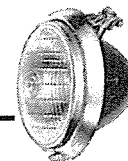

## DETAILED SPARE PARTS

†50695F F700 C.P.R. (50941)	†50700E F700P-EF C.P.R. (50984)	†50705D PF770 C.P.R. (50825)	†A50705D PF770 C.P.R. (A50825)	†B50705D PF770 C.P.R. (B50825)	†50723H F700 C.P.R. (50882)	*A50723H F700 C.P.R. —	*B50723H F700 C.P.R. —	†50724H F700 C.P.R. (50882)	†50734D F700P C.P.R. (50982)	†A50734D F700P C.P.R. (50605)	
552913	552949	552792	552792	552792	552936	552936	552936	552936	552913	552913	(1)
552816	552816	552796	552796	552796	552816	552816	552816	552816	552816	552816	(2)
—	—	553979	553979	553979	—	—	—	—	—	—	(3)
—	—	116003	116003	116003	—	—	—	—	—	—	(4)
—	—	552691	552691	552691	—	—	—	—	—	—	(5)
552906	552906	—	—	—	552906	552906	552906	552906	552906	552906	(6)
554872	554872	552686	552686	552686	554872	554872	554872	554872	554872	554872	(7)
186137	186137	101970	101970	101970	186137	186137	186137	186137	186137	186137	(8)
554871	554871	552704	552704	552704	554871	554871	554871	554871	554871	554871	(9)
553537	553537	—	—	—	553537	553537	553537	553537	553537	553537	(10)
553759	554253	553961	553961	553961	553759	553759	553759	553759	556075	556075	(11)
—	—	552687	552687	552687	—	—	—	—	—	—	(12)
—	—	—	—	—	—	—	—	—	—	—	(13)
—	—	100329	100329	100329	—	—	—	—	—	—	(14)
—	—	552444	552444	552444	—	—	—	—	—	—	(15)
554607	562303	554602	554602	554602	554602	554602	554602	554607	554603	554603	(16)
555910	555910	555910	555910	555910	555910	555910	555910	555910	555910	555910	(17)
—	553780	—	—	—	—	—	—	—	553780	553780	(18)
—	562304	553480	553480	553480	—	—	—	—	—	—	(19)
—	562306	—	—	—	—	—	—	—	—	—	(20)
325	222	302	303	370	354	355	370	325	354   222	355   222	(21)
—	—	—	—	—	—	—	—	—	—	—	(22)
—	—	—	—	—	—	—	—	—	—	—	(23)
552915	552996	552688	552688	552688	553561	553561	553561	553561	552915	552915	(24)
554288	554288	554288	554288	554288	554288	554288	554288	554288	554288	554288	(25)
552813	552813	553483	553483	553483	552813	552813	552813	552813	552813	552813	(26)
—	—	—	—	—	—	—	—	—	—	—	(27)
—	—	—	—	—	—	—	—	—	—	—	(28)
554626	554626	—	—	—	554626	554626	554626	554626	554626	554626	(29)
—	—	117020	117020	117020	—	—	—	—	—	—	(30)

50757E F700P-EF C.P.R. —	50778A PF770 C.P.R. —	A50778A PF770 C.P.R. —	B50778A PF770 C.P.R. —	†50779A PF770 C.P.R. (50778)	†50780A PF770EF C.P.R. (51194)	50781A/B PF770 C.P.R. —	†50790E F700EF C.P.R. (51342)	†50792B F575P C.P.R. (50613)	*A50792B F575P C.P.R. —	*B50792B F575P C.P.R. —	
552936	553620	553620	553620	553620	553620	553620	552913	552822	552822	552822	(1)
552816	552796	552796	552796	552796	552796	552796	552816	553494	553494	552494	(2)
—	553623	553623	553623	553623	553623	553623	—	—	—	—	(3)
—	116003	116003	116003	116003	116003	116003	—	—	—	—	(4)
—	552691	552691	552691	552691	552691	552691	—	—	—	—	(5)
552906	—	—	—	—	—	—	552906	552806	552806	552806	(6)
554872	552686	552686	552686	552686	552686	554596	554872	552805	552805	552805	(7)
186137	—	—	—	—	—	—	186137	—	—	—	(8)
554871	552704	552704	552704	552704	552704	553614	554871	—	—	—	(9)
553537	—	—	—	—	—	—	553537	—	—	—	(10)
554253	553961	553961	553961	553961	553961	—	553948	552496	552496	552496	(11)
—	552687	552687	552687	552687	552687	—	—	—	—	—	(12)
—	101970	101970	101970	101970	101970	101970	—	—	—	—	(13)
—	100329	100329	100329	100329	100329	100329	—	—	—	—	(14)
—	552444	552444	552444	552444	552444	552444	—	—	—	—	(15)
562303	554602	554602	554602	554602	562303	553724	562303	554610	554610	554610	(16)
555910	555910	555910	555910	555910	555910	555910	555910	555910	555910	555910	(17)
553780	—	—	—	—	—	—	—	553780	553780	553780	(18)
‡562304	553480	553480	553480	553480	‡552943	¶553606	‡552943	—	—	—	(19)
562306	—	—	—	—	562306	—	562306	—	—	—	(20)
222	302	303	370	185	—	—	—	354   222	355   222	370   222	(21)
—	—	—	—	—	—	—	—	—	—	—	(22)
—	—	—	—	—	—	—	—	—	—	—	(23)
553561	552688	552688	552688	552688	552688	552688	552915	552823	552823	552823	(24)
554288	554288	554288	554288	554288	554288	554288	554288	554288	554288	554288	(25)
552813	553483	553483	553483	553483	553483	552813	552813	552813	552813	552813	(26)
—	—	—	—	—	—	132464	—	—	—	—	(27)
—	—	—	—	—	—	§188412	—	—	—	—	(28)
554626	—	—	—	—	—	**199003	554626	—	—	—	(29)
—	117020	117020	117020	117020	117020	117020	—	—	—	—	(30)

For illustrations, see pages G25-G29

\* See Supersession Chart † When ordering, quote part number shown in brackets ‡ Supplied complete with Adaptor 562303 || Pilot  
 ¶ Clamp unit § Washer, clamp screw \*\* Grommet C.P.R. ... Chromium plated rim

continued

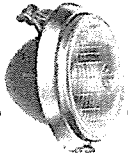

# HEADLAMPS, Flush Fitting

## DETAILED SPARE PARTS

Part No. . . . .		†50793B F700P C.P.R. (51592)	†A50793B F700P C.P.R. (50605)	†B50793B F700P C.P.R. (50983)	50794B F700P C.P.R. —	A50794B F700P C.P.R. —	B50794B F700P C.P.R. —	†50795B F700 C.P.R. (51530)	†50799D F700 C.P.R. (51344)
(1) §Rim or door . . . . .		552913	552913	552913	552923	552923	552923	552949	552912
(2) § Screw, rim fixing . . . . .		552816	552816	552816	552928	552928	552928	552816	552816
(3) Motif, top front . . . . .		—	—	—	—	—	—	—	—
(4) Screw, bracket and motif fixing . . . . .		—	—	—	—	—	—	—	—
(5) Bracket, rim and motif fixing . . . . .		—	—	—	—	—	—	—	—
(6) §Excluder, dust . . . . .		552906	552906	552906	552906	552906	552906	552906	552906
(7) §Plate, light unit retaining . . . . .		554872	554872	554872	554872	554872	554872	554872	554872
(8) Screw, unit rim . . . . .		186137	186137	186137	186137	186137	186137	186137	186137
(9) Rim, unit seating . . . . .		554871	554871	554871	554871	554871	554871	554871	554871
(10) Piece, packing . . . . .		553537	553537	553537	553537	553537	553537	553537	553537
(11) §Light unit . . . . .		556075	556075	556075	556075	556075	556075	555447	553759
(12) Spring, light unit fixing . . . . .		—	—	—	—	—	—	—	—
(13) Screw, plate fixing . . . . .		—	—	—	—	—	—	—	—
(14) Screw, pivot . . . . .		—	—	—	—	—	—	—	—
(15) Pivot . . . . .		—	—	—	—	—	—	—	—
(16) §Bulb holder . . . . .		554603	554603	554603	554603	554603	554603	554602	554602
(17) § Sleeve, terminal . . . . .		555910	555910	555910	555910	555910	555910	555910	555910
(18) § Interior, pilot bulb holder . . . . .		553780	553780	553780	553780	553780	553780	—	—
(19) §Backshell . . . . .		—	—	—	—	—	—	—	—
(20) Clip and screw, adaptor . . . . .		—	—	—	—	—	—	—	—
(21) §Bulb, main . . . . .		354 ‡222	355 ‡222	370 ‡222	354 ‡222	355 ‡222	370 ‡222	355	354
(22) §Buffer, rubber . . . . .		—	—	—	—	—	—	—	—
(23) Conversion adaptor . . . . .		—	—	—	—	—	—	—	—
(24) §Gasket, rubber . . . . .		552915	552915	552915	552922	552922	552922	552996	553561
(25) Screw, with washer . . . . .		—	—	—	554288	554288	554288	554288	554288
(26) Spring, trimmer . . . . .		552813	552813	552813	552813	552813	552813	552813	552813
(27) Screw, motif fixing . . . . .		—	—	—	—	—	—	—	—
(28) Sleeve, sealing . . . . .		—	554626	554626	554626	554626	554626	554626	—
(29) Motif . . . . .		—	—	—	—	—	—	—	—
(30) Screw, body fixing . . . . .		—	—	—	—	—	—	—	—

Part No. . . . .		50822B F575P-1EF C.P.R.	50825A PF770 C.P.R.	A50825A PF770 C.P.R.	B50825A PF770 C.P.R.	†50826A PF770 C.P.R. (50825)	†50835A F700 C.P.R. (51417)	†A50835A F700 C.P.R. (51530)	†B50835A F700 C.P.R. (51419)
(1) §Rim or door . . . . .		552529	552792	552792	552792	552792	552949	552949	552949
(2) § Screw, rim fixing . . . . .		—	552796	552796	552796	552796	552816	552816	552816
(3) Motif, top front . . . . .		—	553979	553979	553979	553979	—	—	—
(4) Screw, bracket and motif fixing . . . . .		—	116003	116003	116003	116003	—	—	—
(5) Bracket, rim and motif fixing . . . . .		—	552691	552691	552691	552691	—	—	—
(6) §Excluder, dust . . . . .		—	—	—	—	—	552906	552906	552906
(7) §Plate, light unit retaining . . . . .		—	552686	552686	552686	552686	554872	554872	554872
(8) Screw, unit rim . . . . .		—	—	—	—	—	186137	186137	186137
(9) Rim, unit seating . . . . .		—	552704	552704	552704	552704	554871	554871	554871
(10) Piece, packing . . . . .		—	—	—	—	—	553537	553537	553537
(11) §Light unit . . . . .		552849	553961	553961	553961	553961	553759	553759	553759
(12) Spring, light unit fixing . . . . .		504665	552687	552687	552687	552687	—	—	—
(13) Screw, plate fixing . . . . .		552517	101970	101970	101970	101970	—	—	—
(14) Screw, pivot . . . . .		—	100329	100329	100329	100329	—	—	—
(15) Pivot . . . . .		—	552444	552444	552444	552444	—	—	—
(16) §Bulb holder . . . . .		562303	554602	554602	554602	554602	554602	554602	554602
(17) § Sleeve, terminal . . . . .		—	555910	555910	555910	555910	555910	555910	555910
(18) § Interior, pilot bulb holder . . . . .		553780	—	—	—	—	—	—	—
(19) §Backshell . . . . .		562304	553480	553480	553480	553480	—	—	—
(20) Clip and screw, adaptor . . . . .		562306	—	—	—	—	—	—	—
(21) §Bulb, main . . . . .		‡222	302	303	370	185	354	355	370
(22) §Buffer, rubber . . . . .		—	—	—	—	—	—	—	—
(23) Conversion adaptor . . . . .		—	—	—	—	—	—	—	—
(24) §Gasket, rubber . . . . .		—	552688	552688	552688	552688	552996	552996	552996
(25) Screw, with washer . . . . .		—	554288	554288	554288	554288	554288	554288	554288
(26) Spring, trimmer . . . . .		512714	553483	553483	553483	553483	552813	552813	552813
(27) Screw, motif fixing . . . . .		—	—	—	—	—	—	—	—
(28) Sleeve, sealing . . . . .		—	—	—	—	—	554626	554626	554626
(29) Grommet . . . . .		—	—	—	—	—	—	—	—
(30) Screw, body fixing . . . . .		—	117020	117020	117020	117020	—	—	—
(31) Pin, split . . . . .		186711	—	—	—	—	—	—	—
(32) Nut, barrel . . . . .		169321	—	—	—	—	—	—	—
(33) Bung, rubber, pivot . . . . .		552530	—	—	—	—	—	—	—

For illustrations, see pages G25-G29

Note. For replacement lamp spare parts, see appropriate column under part number † When ordering, quote part number shown in brackets  
 ‡ Pilot § Recommended spares for stock ¶ Supplied complete with Adaptor 562303 C.P.R. . . . Chromium plated rim

# HEADLAMPS, Flush Fitting

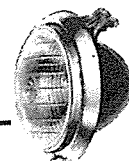

## DETAILED SPARE PARTS

†A50799D F700 C.P.R. (51344)	†B50799D F700 C.P.R. (51346)	†50802A F700P-EF C.P.R. (50679)	†50803A F700 C.P.R. (51509)	†50804A/D F700 C.P.R. (51509)	50806A F575/700 C.P.R. —	†50807B F700 C.P.R. (51467)	†50808D F700EF C.P.R. (51411)	50811A F700 C.P.R. —	50812A F700 C.P.R. —	50817D RF770 C.P.R. —	
552912	552912	552913	552913	552913	552913	552912	552912	552913	552923	552678	(1)
552816	552816	552816	552816	552816	552816	552816	552816	552816	552816	552796	(2)
—	—	—	—	—	—	—	—	—	—	552689	(3)
—	—	—	—	—	—	—	—	—	—	116003	(4)
—	—	—	—	—	—	—	—	—	—	552691	(5)
552906	552906	552906	552906	552906	—	552906	552906	552906	552906	—	(6)
554872	554872	554872	554872	554872	553715	554872	554872	554872	554872	554596	(7)
186137	186137	186137	186137	186137	126463	186137	186137	186137	186137	—	(8)
554871	554871	554871	554871	554871	553717	554871	554871	554871	554871	553614	(9)
553537	553537	553537	553537	553537	—	553537	553537	553537	553537	—	(10)
553759	553759	554253	555447	555447	—	—	553948	—	—	—	(11)
—	—	—	—	—	500291	—	—	—	—	—	(12)
—	—	—	—	—	553494	—	—	—	—	101970	(13)
—	—	—	—	—	—	—	—	—	—	100329	(14)
—	—	—	—	—	—	—	—	—	—	552444	(15)
554602	554602	562303	554602	554602	553724	553724	562303	553724	553724	—	(16)
555910	555910	555910	555910	555910	—	—	555910	—	—	—	(17)
—	—	553780	—	—	—	—	—	—	—	—	(18)
—	—	‡562304	—	—	—	—	—	—	—	—	(19)
—	—	562306	—	—	—	—	‡552943	—	—	—	(20)
355	370	‡222	355	355	—	—	562306	—	—	—	(21)
—	—	—	—	—	—	—	—	—	—	—	(22)
—	—	—	—	—	—	—	—	—	—	—	(23)
553561	553561	552915	552915	552915	553718	553561	553561	552915	552922	552688	(24)
554288	554288	554288	554288	554288	—	554288	554288	554288	554288	554288	(25)
552813	552813	552813	552813	552813	—	552813	552813	552813	552813	552813	(26)
—	—	—	—	—	—	—	—	—	—	—	(27)
—	—	554626	554626	554626	—	554626	554626	554626	554626	—	(28)
—	—	—	—	—	—	—	—	—	—	—	(29)
—	—	—	—	—	‡126544	—	—	—	—	117020	(30)

†50836A F700 C.P.R. (51417)	†50837A F700EF C.P.R. (51420)	50838A PF770 C.P.R. —	A50838A PF770 C.P.R. —	B50838A PF770 C.P.R. —	†50839A PF770 C.P.R. (50838)	†50840A PF770 C.P.R. (51194)	50841A PF770 C.P.R. —	50848A PF770EF C.P.R. —	50849A/B RF770 C.P.R. —	B50849A/B RF770 C.P.R. —	
552949	552949	553620	553620	553620	553620	553620	553620	552792	552678	552678	(1)
552816	552816	552796	552796	552796	552796	552796	552796	552796	552796	552796	(2)
—	—	553623	553623	553623	553623	553623	553623	553979	552689	552689	(3)
—	—	116003	116003	116003	116003	116003	116003	116003	116003	116003	(4)
—	—	552691	552691	552691	552691	552691	552691	552691	552691	552691	(5)
552906	552906	—	—	—	—	—	—	—	—	—	(6)
554872	554872	552686	552686	552686	552686	552686	554596	552686	552686	552686	(7)
186137	186137	—	—	—	—	—	—	—	—	—	(8)
554871	554871	552704	552704	552704	552704	552704	553614	552704	552704	552704	(9)
553537	553537	—	—	—	—	—	—	—	—	—	(10)
553759	553948	553961	553961	553961	553961	553961	—	553961	553627	553627	(11)
—	—	552687	552687	552687	552687	552687	—	552687	552687	552687	(12)
—	—	101970	101970	101970	101970	101970	101970	101970	101970	101970	(13)
—	—	100329	100329	100329	100329	100329	100329	100329	100329	100329	(14)
—	—	552444	552444	552444	552444	552444	552444	552444	552444	552444	(15)
554607	562303	554602	554602	554602	554607	562303	562303	562303	554602	554602	(16)
555910	555910	555910	555910	555910	555910	555910	555910	555910	555910	555910	(17)
—	—	—	—	—	—	—	—	—	—	—	(18)
—	‡552943	553480	553480	553480	553480	‡552943	—	‡552943	553480	553480	(19)
325	562306	—	—	—	—	562306	—	562306	—	—	(20)
—	—	302	303	370	185	—	—	—	185	370	(21)
—	—	—	—	—	—	—	—	—	—	—	(22)
—	—	—	—	—	—	—	—	—	—	—	(23)
552996	552996	552688	552688	552688	552688	552688	552688	552688	552688	552688	(24)
554288	554288	554288	554288	554288	554288	554288	554288	554288	554288	554288	(25)
552813	552813	553483	553483	553483	553483	553483	552813	553483	553483	553483	(26)
—	—	—	—	—	—	—	—	—	—	—	(27)
554626	554626	—	—	—	—	—	—	—	—	—	(28)
—	—	—	—	—	—	—	—	—	—	—	(29)
—	—	117020	117020	117020	117020	117020	117020	117020	199003	199003	(30)
—	—	—	—	—	—	—	—	—	117020	117020	(31)
—	—	—	—	—	—	—	—	—	—	—	(32)
—	—	—	—	—	—	—	—	—	—	—	(33)

For illustrations, see pages G25-G29

† When ordering, quote part number shown in brackets  
C.P.R. ... Chromium plated rim

‡ Supplied complete with Adaptor 562303

¶ Pilot

‡ Order separately

continued

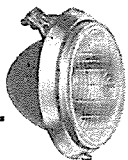

# HEADLAMPS, Flush Fitting

## DETAILED SPARE PARTS

Part No. . . . .	†50852B	†A50852B	†B50852B	†50857B	†A50857B	†B50857B	†50858B	†50859B	
Model . . . . .	PF770	PF770	PF770	F700	F700	F700	F700	F700EF	
Finish . . . . .	C.P.R.	C.P.R.	C.P.R.	—	—	—	—	—	
Replaced by (see footnote) . . . . .	(50825)	(A50825)	(B50825)	(51468)	(51469)	(51470)	(51468)	(50977)	
(1) §Rim or door . . . . .	553667	553667	553667	—	—	—	—	—	
(2) § Screw, rim fixing . . . . .	552796	552796	552796	—	—	—	—	—	
(3) Motif, top front . . . . .	—	—	—	—	—	—	—	—	
(4) Screw, bracket and motif fixing . . . . .	116003	116003	116003	—	—	—	—	—	
(5) Bracket, rim and motif fixing . . . . .	552691	552691	552691	—	—	—	—	—	
(6) §Excluder, dust . . . . .	—	—	—	552906	552906	552906	552906	552906	
(7) §Plate, light unit retaining . . . . .	552686	552686	552686	554872	554872	554872	554872	554872	
(8) Screw, unit rim . . . . .	—	—	—	186137	186137	186137	186137	186137	
(9) Rim, unit seating . . . . .	552704	552704	552704	554871	554871	554871	554871	554871	
(10) Piece, packing . . . . .	—	—	—	553537	553537	553537	553537	553537	
(11) §Light unit . . . . .	553961	553961	553961	553759	553759	553759	553759	553948	
(12) Spring, light unit fixing . . . . .	552687	552687	552687	—	—	—	—	—	
(13) Screw, plate fixing . . . . .	101970	101970	101970	—	—	—	—	—	
(14) Screw, pivot . . . . .	100329	100329	100329	—	—	—	—	—	
(15) Pivot . . . . .	552444	552444	552444	—	—	—	—	—	
(16) §Bulb holder . . . . .	554602	554602	554602	554602	554602	554602	554607	562303	
(17) § Sleeve, terminal . . . . .	555910	555910	555910	555910	555910	555910	555910	555910	
(18) § Interior, pilot bulb holder . . . . .	—	—	—	—	—	—	—	—	
(19) §Backshell . . . . .	553480	553480	553480	—	—	—	—	—	†552943
(20) Clip and screw, adaptor . . . . .	—	—	—	—	—	—	—	—	562306
(21) §Bulb, main . . . . .	302	303	370	354	355	370	325	—	
(22) §Buffer, rubber . . . . .	—	—	—	—	—	—	—	—	
(23) Conversion adaptor . . . . .	—	—	—	—	—	—	—	—	
(24) §Gasket, rubber . . . . .	552688	552688	552688	553561	553561	553561	553561	553561	
(25) Screw, with washer . . . . .	554288	554288	554288	554288	554288	554288	554288	554288	
(26) Spring, trimmer . . . . .	553483	553483	553483	552813	552813	552813	552813	552813	
(27) Screw, motif fixing . . . . .	—	—	—	—	—	—	—	—	
(28) Washer, spring . . . . .	—	—	—	—	—	—	—	—	
(29) Motif . . . . .	—	—	—	—	—	—	—	—	
(30) Screw, body fixing . . . . .	117020	117020	117020	—	—	—	—	—	
(31) Sleeve, sealing . . . . .	—	—	—	554626	554626	554626	554626	554626	

Part No. . . . .	50900A	A50900A	B50900A	†50901A	50913A/D	†50919A/B	50920A	50933A	
Model . . . . .	PF770	PF770	PF770	PF770	PF770	F700	PF770	PF770	
Finish . . . . .	C.P.R.	C.P.R.	C.P.R.	C.P.R.	C.P.R.	—	C.P.R.	C.P.R.	
Replaced by (see footnote) . . . . .	—	—	—	(50900)	—	(51587)	—	—	
(1) §Rim or door . . . . .	552792	552792	552792	552792	552792	—	553844	553956	
(2) § Screw, rim fixing . . . . .	552796	552796	552796	552796	554582	552796	552816	552796	
(3) Motif, top front . . . . .	553979	553979	553979	553979	553979	—	—	553864	
(4) Screw, bracket and motif fixing . . . . .	116003	116003	116003	116003	116003	—	—	116003	
(5) Bracket, rim and motif fixing . . . . .	552691	552691	552691	552691	552691	—	—	553953	
(6) §Excluder, dust . . . . .	—	—	—	—	—	‡553752	—	553954	
(7) §Plate, light unit retaining . . . . .	552686	552686	552686	552686	552686	554872	552686	553878	
(8) Screw, unit rim . . . . .	—	—	—	—	—	186137	—	—	
(9) Rim, unit seating . . . . .	552704	552704	552704	552704	‡552704	554871	552704	553877	
(10) Piece, packing . . . . .	—	—	—	—	—	553537	—	186137	
(11) §Light unit . . . . .	553982	553982	553982	553982	553961	—	553961	553961	
(12) Spring, light unit fixing . . . . .	552687	552687	552687	552687	552687	—	552687	—	
(13) Screw, plate fixing . . . . .	101970	101970	101970	101970	101970	—	101970	—	
(14) Screw, pivot . . . . .	100329	100329	100329	100329	100329	—	100329	—	
(15) Pivot . . . . .	552444	552444	552444	552444	552444	—	552444	—	
(16) §Bulb holder . . . . .	554602	554602	554602	554607	554602	553724	554602	554602	
(17) § Sleeve, terminal . . . . .	555910	555910	555910	555910	555910	—	555910	555910	
(18) § Interior, pilot bulb holder . . . . .	—	—	—	—	—	—	—	—	
(19) §Backshell . . . . .	553480	553480	553480	553480	553480	—	553480	553480	
(20) Clip and screw, adaptor . . . . .	—	—	—	—	—	—	—	—	
(21) §Bulb, main . . . . .	302	303	370	185	302	—	302	302	
(22) §Buffer, rubber . . . . .	—	—	—	—	—	—	—	553875	
(23) Conversion adaptor . . . . .	—	—	—	—	—	—	—	—	
(24) §Gasket, rubber . . . . .	552688	552688	552688	552688	552688	—	552688	553955	
(25) Screw, with washer . . . . .	554288	554288	554288	554288	554288	554288	554288	*552708	
(26) Spring, trimmer . . . . .	553483	553483	553483	553483	553483	552813	553483	553872	
(27) Sleeve, sealing . . . . .	—	—	—	—	—	554626	—	554626	
(28) Washer, spring . . . . .	—	—	—	—	—	—	—	—	
(29) Grommet . . . . .	—	—	—	199003	199003	—	—	—	
(30) Screw, body fixing . . . . .	117020	117020	117020	117020	117020	—	117020	177020	

For illustrations, see pages G25-G29

Note. For replacement lamp spare parts, see appropriate column under part number † See Supersession Chart ‡ When ordering, quote part number shown in brackets  
 † Supplied complete with Adaptor 562303 § Recommended spares for stock ‡ Supplied separately † Ring, fixing C.P.R. . . Chromium plated rim

# HEADLAMPS, Flush Fitting

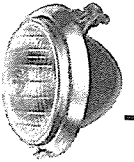

## DETAILED SPARE PARTS

	50864B RF770EF C.P.R.	50874A F700 C.P.R.	†50878A F700 C.P.R. (51336)	†A50878A F700 C.P.R. (51509)	†B50878A F700 C.P.R. (51339)	†50879A F700 C.P.R. (51344)	†50880A F700 C.P.R. (51336)	†50881A F700 C.P.R. (51344)	50882A F700 C.P.R. —	†50884A F700 C.P.R. (51417)	†50885A F700 C.P.R. (51417)	
	552678	552912	552913	552913	552913	552912	552913	552912	552936	552949	552949	(1)
	552796	552816	552816	552816	552816	552816	552816	552816	552816	552816	552816	(2)
	552689	—	—	—	—	—	—	—	—	—	—	(3)
	116003	—	—	—	—	—	—	—	—	—	—	(4)
	552691	—	—	—	—	—	—	—	‡552970	—	—	(5)
	—	552906	552906	552906	552906	552906	552906	552906	552906	552906	552906	(6)
	552686	554872	554872	554872	554872	554872	554872	554872	554872	554872	554872	(7)
	—	186137	186137	186137	186137	186137	186137	186137	186137	186137	186137	(8)
	552704	554871	554871	554871	554871	554871	554871	554871	554871	554871	554871	(9)
	—	553537	553537	553537	553537	553537	553537	553537	553537	553537	553537	(10)
	553476	553759	553759	553759	553759	553759	553759	553759	553759	553759	553759	(11)
	552687	—	—	—	—	—	—	—	‡‡512505	—	—	(12)
	101970	—	—	—	—	—	—	—	—	—	—	(13)
	100329	—	—	—	—	—	—	—	—	—	—	(14)
	552444	—	—	—	—	—	—	—	—	—	—	(15)
	562303	554602	554602	554602	554602	554602	554607	554607	554602	554602	554607	(16)
	555910	555910	555910	555910	555910	555910	555910	555910	555910	555910	555910	(17)
	—	—	—	—	—	—	—	—	—	—	—	(18)
	‡552943	—	—	—	—	—	—	—	—	—	—	(19)
	562306	—	—	—	—	—	—	—	—	—	—	(20)
	—	326	354	355	370	354	325	325	354	354	325	(21)
	—	—	—	—	—	—	—	—	—	—	—	(22)
	—	—	—	—	—	—	—	—	—	—	—	(23)
	552688	553561	552915	552915	552915	553561	552915	553561	553561	552996	552996	(24)
	554288	554288	554288	554288	554288	554288	554288	554288	554289	554288	554288	(25)
	553483	552813	552813	552813	552813	552813	552813	552813	552813	552813	552813	(26)
	—	—	—	—	—	—	—	—	—	—	—	(27)
	—	—	—	—	—	—	—	—	—	—	—	(28)
	—	—	—	—	—	—	—	—	—	—	—	(29)
	117020	—	—	—	—	—	—	—	—	—	—	(30)
	—	—	554626	554626	554626	554626	554626	554626	554626	554626	554626	(31)

	A50933A PF770 C.P.R.	B50933A PF770 C.P.R.	†50934A PF770 C.P.R. (50933)	50935A/B PF770EF C.P.R.	50936A PF770 C.P.R.	†50937A PF770 C.P.R. (50781)	50941A F700 C.P.R.	50942A PF770 Chromium	†50954A F700 C.P.R. (51336)	†50959A F700 C.P.R. (51344)	†50960A F700 C.P.R. (51533)	
	553956	553956	553956	553956	553956	553667	552913	552792	552913	552912	552912	(1)
	552796	552796	552796	552796	552796	552796	552816	552796	552816	552816	552816	(2)
	553864	553864	553864	553864	553864	—	—	553979	—	—	—	(3)
	116003	116003	116003	116003	116003	116003	—	116003	—	—	—	(4)
	553953	553953	553953	553953	553953	552691	—	552691	—	—	—	(5)
	553954	553954	553954	553954	553954	—	552906	—	—	552906	552906	(6)
	553878	553878	553878	553971	553971	554596	554872	554596	554872	554872	554872	(7)
	—	—	—	186137	186137	—	186137	—	186137	186137	186137	(8)
	553877	553877	553877	553972	553972	553614	554871	553614	554871	554871	554871	(9)
	186137	186137	186137	—	—	—	553537	—	553537	553537	553537	(10)
	553961	553961	553961	553948	—	—	553921	—	553921	554253	554447	(11)
	—	—	—	—	—	—	—	—	—	—	—	(12)
	—	—	—	—	—	101970	—	101970	—	—	—	(13)
	—	—	—	—	—	100329	—	100329	—	—	—	(14)
	—	—	—	—	—	552444	—	552444	—	—	—	(15)
	554602	554602	554607	562303	553724	553724	554602	553724	554602	554602	554602	(16)
	555910	555910	555910	555910	—	—	555910	—	555910	555910	555910	(17)
	—	—	—	—	—	—	—	—	—	—	—	(18)
	553480	553480	553480	‡552943	—	—	—	—	—	—	—	(19)
	—	—	—	562306	—	—	—	—	—	—	—	(20)
	303	370	185	—	—	—	354	—	354	354	355	(21)
	553875	553875	553875	—	—	—	—	—	—	—	—	(22)
	—	—	—	—	—	—	—	—	—	—	—	(23)
	553955	553955	553955	553955	553955	552688	552915	552688	—	553561	553561	(24)
	*552708	*552708	*552708	*552708	*552708	554288	554288	554288	554288	554288	554288	(25)
	553872	553872	553872	553872	553872	552813	552813	552813	552813	552813	552813	(26)
	554626	554626	554626	554626	554626	—	554626	—	554626	554626	554626	(27)
	—	—	—	—	—	—	—	—	—	—	—	(28)
	—	—	—	—	—	—	—	—	—	—	—	(29)
	117020	117020	117020	117020	117020	117020	—	117020	—	—	—	(30)

For illustrations, see pages G25-G29

\* See Supersession Chart † When ordering, quote part number shown in brackets ‡ Ring, fixing †† Collar, spacing  
 † Supplied complete with Adaptor 562303 C.P.R. .. Chromium plated rim

continued

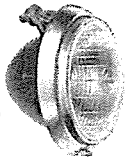

# HEADLAMPS, Flush Fitting

## DETAILED SPARE PARTS

Part No. . . . .	†50961A F700 C.P.R. (51346)	†50962A F700EF C.P.R. (51342)	†50963A F700 C.P.R. (51339)	†50966A F700EF C.P.R. (51342)	50967A F700 C.P.R. —	†50968A F700 C.P.R. (51419)	50973A F700 C.P.R. —	†50974B F700 — (51468)
(1) §Rim or door . . . . .	552912	552913	552913	552913	552913	552949	552913	—
(2) § Screw, rim fixing . . . . .	552816	552816	552816	552816	552816	552816	552816	—
(3) Motif, top front . . . . .	—	—	—	—	—	—	—	—
(4) Screw, bracket and motif fixing . . . . .	—	—	—	—	—	—	—	—
(5) Bracket, rim and motif fixing . . . . .	—	—	—	—	—	—	—	—
(6) §Excluder, dust . . . . .	552906	552906	552906	552906	552906	552906	552906	553752
(7) §Plate, light unit retaining . . . . .	554872	554872	554872	554872	554872	554872	554872	554872
(8) Screw, unit rim . . . . .	186137	186137	186137	186137	186137	186137	186137	186137
(9) Rim, unit seating . . . . .	554871	554871	554871	554871	554871	554871	554871	554871
(10) Piece, packing . . . . .	553537	553537	553537	553537	553537	553537	553537	553537
(11) §Light unit . . . . .	553940	553948	553940	553948	553940	553940	555447	553921
(12) Spring, light unit fixing . . . . .	—	—	—	—	—	—	—	—
(13) Screw, plate fixing . . . . .	—	—	—	—	—	—	—	—
(14) Screw, pivot . . . . .	—	—	—	—	—	—	—	—
(15) Pivot . . . . .	—	—	—	—	—	—	—	—
(16) §Bulb holder . . . . .	554602	562303	554602	562303	554602	554602	554602	554602
(17) § Sleeve, terminal . . . . .	555910	555910	555910	555910	555910	555910	555910	555910
(18) § Interior, pilot bulb holder . . . . .	—	—	—	—	—	—	—	—
(19) §Backshell . . . . .	—	‡552943	—	‡552943	—	—	—	—
(20) Clip and screw, adaptor . . . . .	—	562306	—	562306	—	—	—	—
(21) §Bulb, main . . . . .	370	—	370	—	370	370	355	354
(22) §Buffer, rubber . . . . .	—	—	—	—	—	—	—	—
(23) Conversion adaptor . . . . .	—	—	—	—	—	—	—	—
(24) §Gasket, rubber . . . . .	553561	552915	552915	552915	552915	552996	552915	—
(25) Screw, with washer . . . . .	554288	554288	554288	554288	554288	554288	554288	554288
(26) Spring, trimmer . . . . .	552813	552813	552813	552813	552813	552813	552813	552813
(27) Screw, motif fixing . . . . .	—	—	—	—	—	—	—	—
(28) Washer, spring . . . . .	—	—	—	—	—	—	—	—
(29) Motif . . . . .	—	—	—	—	—	—	—	—
(30) Screw, body fixing . . . . .	—	—	—	—	—	—	—	—
(31) Pin, split . . . . .	—	—	—	—	—	—	—	—
(32) Sleeve, sealing . . . . .	554626	554626	554626	554626	554626	554626	554626	554626

Part No. . . . .	†50993A F700 C.P.R. (51533)	†50994A F700 C.P.R. (51346)	51009A F700EF C.P.R. —	†51010A F700 C.P.R. (51417)	†51011A F700 C.P.R. (51419)	†51012A F700 C.P.R. (51530)	51033A F575 C.P.R. —	51044A F575P C.P.R. —
(1) §Rim or door . . . . .	552912	552912	552912	552949	552949	552949	552822	552822
(2) § Screw, rim fixing . . . . .	552816	552816	552816	552816	552816	552816	553494	552816
(3) Motif, top front . . . . .	—	—	—	—	—	—	—	—
(4) Screw, bracket and motif fixing . . . . .	—	—	—	—	—	—	—	—
(5) Bracket, rim and motif fixing . . . . .	—	—	—	—	—	—	—	552817
(6) §Excluder, dust . . . . .	552906	552906	552906	552906	552906	552906	552806	552806
(7) §Plate, light unit retaining . . . . .	554872	554872	554872	554872	554872	554872	552805	552805
(8) Screw, unit rim . . . . .	186137	186137	186137	186137	186137	186137	—	—
(9) Rim, unit seating . . . . .	554871	554871	554871	554871	554871	554871	—	—
(10) Piece, packing . . . . .	553537	553537	553537	553537	553537	553537	—	—
(11) §Light unit . . . . .	555447	553940	553948	553921	553940	555447	553695	553700
(12) Spring, light unit fixing . . . . .	—	—	—	—	—	—	—	—
(13) Screw, plate fixing . . . . .	—	—	—	—	—	—	—	—
(14) Screw, pivot . . . . .	—	—	—	—	—	—	—	—
(15) Pivot . . . . .	—	—	—	—	—	—	—	—
(16) §Bulb holder . . . . .	554602	554602	562303	554602	554602	554602	554602	554610
(17) § Sleeve, terminal . . . . .	555910	555910	555910	555910	555910	555910	555910	555910
(18) § Interior, pilot bulb holder . . . . .	—	—	—	—	—	—	—	553780
(19) §Backshell . . . . .	—	—	‡552943	—	—	—	—	—
(20) Clip and screw, adaptor . . . . .	—	—	562306	—	—	—	—	—
(21) §Bulb, main . . . . .	355	370	—	354	370	355	312	312 †988
(22) §Buffer, rubber . . . . .	—	—	—	—	—	—	—	—
(23) Conversion adaptor . . . . .	—	—	—	—	—	—	—	—
(24) §Gasket, rubber . . . . .	553561	553561	552915	552996	552996	552996	552823	552823
(25) Screw, with washer . . . . .	554288	554288	554288	554288	554288	554288	554288	554288
(26) Spring, trimmer . . . . .	552813	552813	552813	552813	552813	552813	552813	552813
(27) Screw, motif fixing . . . . .	—	—	—	—	—	—	—	—
(28) Washer, spring . . . . .	—	—	—	—	—	—	—	—
(29) Sleeve, sealing . . . . .	554626	554626	554626	554626	554626	554626	554626	554626
(30) Screw, body fixing . . . . .	—	—	—	—	—	—	—	—

For illustrations, see pages G25-G29

Note. For replacement lamp spare parts, see appropriate column under part number † When ordering, quote part number shown in brackets  
 ‡ Supplied complete with Adaptor 562303 § Recommended spares for stock ¶ Pilot C.P.R. . . . Chromium plated rim

# HEADLAMPS, Flush Fitting

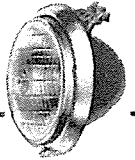

## DETAILED SPARE PARTS

†50975B F700 — (51469)	†50976B F700 — (51470)	50977A F700EF — —	†50978A F700EF C.P.R. (51411)	†50979A PF700 C.P.R. (51065)	†50980A PF770 C.P.R. (51065)	50981B PF770EF C.P.R. —	50982A F700P C.P.R. —	50983A F700P C.P.R. —	50984A F700P-EF C.P.R. —	†50992A F700 C.P.R. (51344)	
—	—	—	552912	553965	553978	553965	552913	552913	552913	552912	(1)
—	—	—	552816	552796	554582	554582	552816	552816	552816	552816	(2)
—	—	—	—	—	553980	—	—	—	—	—	(3)
—	—	—	—	116003	116003	116003	—	—	—	—	(4)
—	—	—	—	553953	553953	553953	—	—	—	—	(5)
553752	553752	553752	552906	553954	553954	553954	552906	552906	552906	552906	(6)
554872	554872	554872	554872	553878	553878	553878	554872	554872	554872	554872	(7)
186137	186137	186137	186137	186137	186137	186137	186137	186137	186137	186137	(8)
554871	554871	554871	554871	553877	553877	553877	554871	554871	554871	554871	(9)
553537	553537	553537	553537	—	—	—	553537	553537	553537	553537	(10)
555447	553940	553948	553948	553961	553961	553961	556376	556288	554253	553921	(11)
—	—	—	—	—	—	—	—	—	—	—	(12)
—	—	—	—	—	—	—	—	—	—	—	(13)
—	—	—	—	—	—	—	—	—	—	—	(14)
—	—	—	—	—	—	—	—	—	—	—	(15)
554602	554602	562303	562303	554602	554602	562303	554603	554603	562303	554602	(16)
555910	555910	555910	555910	555910	555910	555910	555910	555910	555910	555910	(17)
—	—	—	—	—	—	—	553780	553780	553780	—	(18)
—	—	†552943	†552943	553480	553480	†552943	—	—	†562304	—	(19)
—	—	562306	562306	5511658	—	562306	—	—	562306	—	(20)
355	370	—	—	302	302	—	354 †222	370 †222	†222	354	(21)
—	—	—	—	553875	—	—	—	—	—	—	(22)
—	—	—	—	—	—	—	—	—	—	—	(23)
—	—	—	553561	553955	553955	553955	552915	552915	—	553561	(24)
554288	554288	554288	554288	*552708	*552708	*552708	554288	554288	554288	554288	(25)
552813	552813	552813	552813	553872	553872	553872	552813	552813	552813	552813	(26)
—	—	—	—	—	—	—	—	—	—	—	(27)
—	—	—	—	—	—	—	—	—	—	—	(28)
—	—	—	—	—	—	—	—	—	—	—	(29)
—	—	—	—	117020	117020	117020	—	—	—	—	(30)
—	—	—	—	186711	—	—	—	—	—	—	(31)
554626	554626	554626	554626	554626	554626	554626	554626	554626	554626	554626	(32)

51054A PF770 C.P.R. —	A51054A PF770 C.P.R. —	B51054A PF770 C.P.R. —	†51055A PF770 C.P.R. (51054)	†51056A PF770EF C.P.R. (51484)	51065A/B PF770 C.P.R. —	A51065A/B PF770 C.P.R. —	B51065A/B PF770 C.P.R. —	†51066A PF770 C.P.R. (51065)	51067B PF770 C.P.R. —	51073B P700 C.P.R. —	
553978	553978	553978	553978	553978	553978	553978	553978	553978	553978	552912	(1)
554582	554582	554582	554582	554582	554582	554582	554582	554582	554582	552816	(2)
553980	553980	553980	553980	553980	553980	553980	553980	553980	553980	—	(3)
116003	116003	116003	116003	116003	116003	116003	116003	116003	116003	—	(4)
553953	553953	553953	553953	553953	553953	553953	553953	553953	553953	—	(5)
553954	553954	553954	553954	553954	553954	553954	553954	553954	553954	552906	(6)
553878	553878	553878	553878	553971	553878	553878	553878	553878	553971	554872	(7)
186137	186137	186137	186137	186137	186137	186137	186137	186137	186137	186137	(8)
553877	553877	553877	553877	553972	553877	553877	553877	553877	553972	554871	(9)
—	—	—	—	—	—	—	—	—	—	—	(10)
553982	553982	553982	553982	553948	553961	553961	553961	553961	—	554308	(11)
—	—	—	—	—	—	—	—	—	—	—	(12)
—	—	—	—	—	—	—	—	—	—	—	(13)
—	—	—	—	—	—	—	—	—	—	—	(14)
—	—	—	—	—	—	—	—	—	—	—	(15)
554602	554602	554602	554607	562303	554602	554602	554602	554607	553724	554602	(16)
555910	555910	555910	555910	555910	555910	555910	555910	555910	—	555910	(17)
—	—	—	—	—	—	—	—	—	—	—	(18)
553480	553480	553480	553480	†552943	553480	553480	553480	553480	—	—	(19)
—	—	—	—	562306	—	—	—	—	—	—	(20)
302	303	370	185	—	302	303	370	185	—	354	(21)
553875	553875	553875	553875	—	553875	553875	553875	553875	—	—	(22)
—	—	—	—	—	—	—	—	—	—	—	(23)
553955	553955	553955	553955	553955	553955	553955	553955	553955	553955	553561	(24)
*552708	*552708	*552708	*552708	*552708	*552708	*552708	*552708	*552708	*552708	554288	(25)
553872	553872	553872	553872	553872	553872	553872	553872	553872	553872	552813	(26)
—	—	—	—	—	—	—	—	—	—	—	(27)
—	—	—	—	—	—	—	—	—	—	—	(28)
554626	554626	554626	554626	554626	554626	554626	554626	554626	554626	554626	(29)
117020	117020	117020	117020	117020	117020	117020	117020	117020	117020	—	(30)

For illustrations, see pages G25-G29

\* See Supersession Chart  
‡ Spring, backshell securing

† When ordering, quote part number shown in brackets  
\* Pilot C.P.R. . . Chromium plated rim

‡ Supplied complete with Adaptor 562303

continued

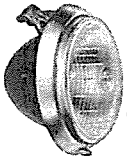

# HEADLAMPS, Flush Fitting

## DETAILED SPARE PARTS

Part No. . . . .	51087B RF770EF C.P.R.	†51088B RF770 C.P.R. (51293)	†51089A RF770 C.P.R. (51296)	51092A PF770EF C.P.R.	51194B PF770EF C.P.R.	†51216A PF770 C.P.R. (51065)	†A51216A PF770 C.P.R. (A51065)	†B51216A PF770 C.P.R. (B51065)
Model . . . . .								
Finish . . . . .								
Replaced by (see footnote)								
(1) §Rim or door . . . . .	553996	553996	553996	553844	553620	553965	553965	553965
(2) § Screw, rim fixing . . . . .	554582	554582	554582	552816	554582	552796	552796	552796
(3) Motif, top front . . . . .	553967	553967	553967	—	553623	—	—	—
(4) Screw, bracket and motif fixing . . . . .	116003	116003	116003	—	116003	116003	116003	116003
(5) Bracket, rim and motif fixing . . . . .	553953	553953	553953	—	552691	553953	553953	553953
(6) §Excluder, dust . . . . .	553954	553954	553954	—	—	553954	553954	553954
(7) §Plate, light unit retaining . . . . .	553878	553971	553878	554596	554596	553878	553878	553878
(8) Screw, unit rim . . . . .	186137	186137	186137	—	—	186137	186137	186137
(9) Rim, unit seating . . . . .	553877	553972	553877	553614	553614	553877	553877	553877
(10) Piece, packing . . . . .	—	—	—	—	—	—	—	—
(11) §Light unit . . . . .	553476	553476	553627	553948	553948	553961	553961	553961
(12) Spring, light unit fixing . . . . .	—	—	—	—	—	—	—	—
(13) Screw, plate fixing . . . . .	—	—	—	101970	101970	—	—	—
(14) Screw, pivot . . . . .	—	—	—	100329	100329	—	—	—
(15) Pivot . . . . .	—	—	—	552444	552444	—	—	—
(16) §Bulb holder . . . . .	562303	—	554602	562303	562303	554602	554602	554602
(17) § Sleeve, terminal . . . . .	555910	—	555910	555910	555910	555910	555910	555910
(18) § Interior, pilot bulb holder . . . . .	—	—	—	—	—	—	—	—
(19) §Backshell . . . . .	†553999	—	553480	†552943	†552943	553480	553480	553480
(20) Clip and screw, adaptor . . . . .	562306	—	—	562306	562306	—	—	—
(21) §Bulb, main . . . . .	—	—	302	—	—	302	302	370
(22) §Buffer, rubber . . . . .	553875	—	553875	—	—	553875	553875	553875
(23) Conversion adaptor . . . . .	—	—	—	—	—	—	—	—
(24) §Gasket, rubber . . . . .	—	—	—	552688	552688	553955	553955	553955
(25) Screw, with washer . . . . .	*552708	*552708	*552708	554288	554288	*552708	*552708	*552708
(26) Spring, trimmer . . . . .	553872	553872	553872	552813	552813	553872	553872	553872
(27) Screw, motif fixing . . . . .	—	—	—	—	—	—	—	—
(28) Washer, spring . . . . .	—	—	—	—	—	—	—	—
(29) Motif . . . . .	—	—	—	—	—	—	—	—
(30) Screw, body fixing . . . . .	—	—	117020	117020	117020	117020	117020	117020
(31) Sleeve, sealing . . . . .	554626	554626	554626	—	—	554626	554626	554626

Part No. . . . .	51259A/B F700 C.P.R.	51292A RF770 C.P.R.	51293A RF770 C.P.R.	51294B RF770EF C.P.R.	51295A RF770 C.P.R.	51296A RF770 C.P.R.	†51329A F700EF C.P.R. (51420)	†51334A P700 C.P.R. (51596)
Model . . . . .								
Finish . . . . .								
Replaced by (see footnote)								
(1) §Rim or door . . . . .	552912	553996	553996	553996	553996	553996	552949	552913
(2) § Screw, rim fixing . . . . .	552816	554582	554582	554582	554582	554582	552816	552816
(3) Washer, screw retaining . . . . .	—	—	—	—	—	—	—	—
(4) Motif, top front . . . . .	—	553967	553967	553967	553967	553967	—	—
(5) Screw, bracket and motif fixing . . . . .	—	116003	116003	116003	116003	116003	—	—
(6) Bracket, rim and motif fixing . . . . .	—	553953	553953	553953	553953	553953	—	—
(7) §Nut, rim fixing screw . . . . .	—	—	—	—	—	—	—	—
(8) §Excluder, dust . . . . .	552906	553954	553954	553954	553954	553954	552906	552906
(9) §Plate, light unit retaining . . . . .	554872	553878	553971	553971	553971	553878	554872	554872
(10) Screw, unit rim . . . . .	186137	186137	186137	186137	186137	186137	186137	186137
(11) Rim, unit seating . . . . .	554871	553877	553972	553972	553972	553877	554871	554871
(12) Piece, packing . . . . .	553537	—	—	—	—	—	—	—
(13) §Light unit . . . . .	54520136	553476	—	553948	553940	553627	553948	554308
(14) Spring, light unit fixing . . . . .	—	—	—	—	—	—	—	—
(15) Screw, plate fixing . . . . .	—	—	—	—	—	—	—	—
(16) Screw, pivot . . . . .	—	—	—	—	—	—	—	—
(17) Pivot . . . . .	—	—	—	—	—	—	—	—
(18) §Bulb holder . . . . .	512751	554602	—	562303	554602	554602	562303	554602
(19) § Sleeve, terminal . . . . .	555910	555910	555910	555910	555910	555910	555910	555910
(20) § Interior, pilot bulb holder . . . . .	—	—	—	—	—	—	—	—
(21) §Backshell . . . . .	—	553480	—	†552943	—	553480	†552943	—
(22) Clip and screw, adaptor . . . . .	—	—	—	562306	—	—	562306	—
(23) §Bulb, main . . . . .	355	302	—	—	370	302	—	354
(24) §Buffer, rubber . . . . .	—	553875	—	553875	553875	553875	—	—
(25) Conversion adaptor . . . . .	—	—	—	—	—	—	—	—
(26) §Gasket, rubber . . . . .	553561	—	—	—	—	—	552996	552915
(27) Screw, with washer . . . . .	554288	*552708	*552708	*552708	*552708	*552708	554288	554288
(28) Spring, trimmer . . . . .	552813	553872	553872	553872	553872	553872	552813	552813
(29) Screw, motif fixing . . . . .	—	—	—	—	—	—	—	—
(30) Sleeve, sealing . . . . .	554626	554626	554626	554626	554626	554626	554626	554626
(31) Screw, body fixing . . . . .	—	117020	—	117020	117020	117020	—	—

For illustrations, see pages G25–G29

Note. For replacement lamp spare parts, see appropriate column under part number  
 † Supplied complete with Adaptor 562303 § Recommended spares for stock

\* See Supersession Chart † When ordering, quote part number shown in brackets  
 C.P.R. . . . Chromium plated rim



# HEADLAMPS, Flush Fitting

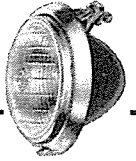

## DETAILED SPARE PARTS

	†51217A PF770 C.P.R. (51065)	†51218A PF770EF C.P.R. (50981)	†51240A F700EF — (51411)	†51246A F700 — (51344)	†51247A/B F700 — (51345)	†51249A F700 — (51336)	†51250A F700 — (51509)	†51251A F700 — (51339)	†51253A F700 — (51343)	†51254A F700 — (51344)	51258A/B F700 C.P.R. —	
	553978	553965	552912	552912	552912	552913	552913	552913	552913	552912	552912	(1)
	552796	552796	552816	552816	552816	552816	552816	552816	552816	552816	552816	(2)
	553980	—	—	—	—	—	—	—	—	—	—	(3)
	116003	116003	—	—	—	—	—	—	—	—	—	(4)
	553953	553953	—	—	—	—	—	—	—	—	—	(5)
	553954	553954	552906	552906	552906	—	552906	552906	552906	552906	552906	(6)
	553878	553878	554872	554872	554872	554872	554872	554872	554872	554872	554872	(7)
	186137	186137	186137	186137	186137	186137	186137	186137	186137	186137	186137	(8)
	553877	553877	554871	554871	554871	554871	554871	554871	554871	554871	554871	(9)
	—	—	—	—	—	553537	553537	553537	553537	553537	553537	(10)
	553961	553961	553948	553921	555447	553921	555447	553940	—	554253	554496	(11)
	—	—	—	—	—	—	—	—	—	—	—	(12)
	—	—	—	—	—	—	—	—	—	—	—	(13)
	—	—	—	—	—	—	—	—	—	—	—	(14)
	—	—	—	—	—	—	—	—	—	—	—	(15)
	554602	562303	562303	554602	554602	554602	554602	554602	553724	554602	512751	(16)
	555910	555910	555910	555910	555910	555910	555910	555910	—	555910	555910	(17)
	—	—	—	—	—	—	—	—	—	—	—	(18)
	553480	‡552943	‡552943	—	—	—	—	—	—	—	—	(19)
	—	562306	562306	—	—	—	—	—	—	—	—	(20)
	302	—	—	354	355	354	355	370	—	354	354	(21)
	553875	553875	—	—	—	—	—	—	—	—	—	(22)
	—	—	—	—	—	—	—	—	—	—	—	(23)
	553955	553955	553561	553561	553561	—	552915	552915	552915	553561	553561	(24)
	*552708	*552708	554288	554288	554288	554288	554288	554288	554288	554288	554288	(25)
	553872	553872	552813	552813	552813	552813	552813	552813	552813	552813	552813	(26)
	—	—	—	—	—	—	—	—	—	—	—	(27)
	—	—	—	—	—	—	—	—	—	—	—	(28)
	—	—	—	—	—	—	—	—	—	—	—	(29)
	117020	117020	—	—	—	—	—	—	—	—	—	(30)
	554626	554626	554626	554626	554626	554626	554626	554626	554626	554626	554626	(31)

	†51335A F700 C.P.R. (51336)	51336A F700 C.P.R. —	51336B/J F700 C.P.R. —	†51337A/B F700 C.P.R. (51509)	51337D/K F700 C.P.R. —	†51338A F700 C.P.R. (51509)	51339A F700 C.P.R. —	51339B/H F700 C.P.R. —	†51340A F700 C.P.R. (51339)	†51341A F700EF C.P.R. (51342)	51341B/E F700EF C.P.R. —	
	554440	554440	554440	554440	554440	554440	554440	554440	554440	554440	554440	(1)
	116141	116141	198898	116141	198898	116141	116141	198898	116141	116141	198898	(2)
	161385	161385	161385	161385	161385	161385	161385	161385	161385	161385	161385	(3)
	—	—	—	—	—	—	—	—	—	—	—	(4)
	—	—	—	—	—	—	—	—	—	—	—	(5)
	554240	554240	555704	554240	555704	554240	554240	555704	554240	554240	555704	(6)
	—	—	187117	—	187117	—	—	187117	—	—	187117	(7)
	552906	552906	552906	552906	552906	552906	552906	552906	552906	552906	552906	(8)
	554872	554872	554872	554872	554872	554872	554872	554872	554872	554872	554872	(9)
	186137	186137	186137	186137	186137	186137	186137	186137	186137	186137	186137	(10)
	554871	554871	554871	554871	554871	554871	554871	554871	554871	554871	554871	(11)
	553537	—	—	—	—	—	—	—	553537	553537	553537	(12)
	553921	553921	553921	555447	555447	555447	553940	553940	553940	553948	553948	(13)
	—	—	—	—	—	—	—	—	—	—	—	(14)
	—	—	—	—	—	—	—	—	—	—	—	(15)
	—	—	—	—	—	—	—	—	—	—	—	(16)
	—	—	—	—	—	—	—	—	—	—	—	(17)
	554602	554602	554602	554602	554602	554602	554602	554602	554602	562303	562303	(18)
	555910	555910	555910	555910	555910	555910	555910	555910	555910	555910	555910	(19)
	—	—	—	—	—	—	—	—	—	—	—	(20)
	—	—	—	—	—	—	—	—	—	‡552943	‡552943	(21)
	—	—	—	—	—	—	—	—	—	562306	562306	(22)
	354	354	414	355	355	355	370	370	370	—	—	(23)
	—	—	—	—	—	—	—	—	—	—	—	(24)
	—	—	—	—	—	—	—	—	—	—	—	(25)
	554280	554280	554280	554280	554280	554280	554280	554280	554280	554280	554280	(26)
	554288	554288	554288	554288	554288	554288	554288	554288	554288	554288	554288	(27)
	552813	552813	552813	552813	552813	552813	552813	552813	552813	552813	552813	(28)
	—	—	—	—	—	—	—	—	—	—	—	(29)
	554626	554626	554626	554626	554626	554626	554626	554626	554626	554626	554626	(30)
	—	—	—	—	—	—	—	—	—	—	—	(31)

For illustrations, see pages G25–G29

\* See Supersession Chart † When ordering, quote part number shown in brackets

‡ Supplied complete with Adaptor 562303

continued

C.P.R. ... Chromium plated rim

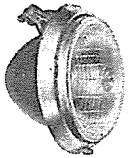

# HEADLAMPS, Flush Fitting

## DETAILED SPARE PARTS

Part No. . . . .	51342A	51342B/D	51343A	51343B/E	51344A	51344B/F	†51345A/B	51345D/F
Model . . . . .	F700EF	F700EF	F700	F700	F700	F700	F700	F700
Finish . . . . .	C.P.R.	C.P.R.	C.P.R.	C.P.R.	C.P.R.	C.P.R.	C.P.R.	C.P.R.
Replaced by (see footnote) . . . . .	—	—	—	—	—	—	(51533)	—
(1) §Rim or door . . . . .	554440	554440	554440	554440	554439	554439	554439	554439
(2) § Screw, rim fixing . . . . .	116141	198898	116141	198898	116141	198898	116141	198898
(3) Washer, screw retaining . . . . .	161385	161385	161385	161385	161385	161385	161385	161385
(4) Motif, top front . . . . .	—	—	—	—	—	—	—	—
(5) Screw, bracket and motif fixing . . . . .	—	—	—	—	—	—	—	—
(6) Bracket, rim and motif fixing . . . . .	554240	555704	554240	555704	554240	555704	554240	555704
(7) Nut, rim fixing screw . . . . .	—	187117	—	187117	—	187117	—	187117
(8) §Excluder, dust . . . . .	552906	552906	552906	552906	552906	552906	552906	552906
(9) §Plate, light unit retaining . . . . .	554872	554872	554872	554872	554872	554872	554872	554872
(10) Screw, unit rim . . . . .	186137	186137	186137	186137	186137	186137	186137	186137
(11) Rim, unit seating . . . . .	554871	554871	554871	554871	554871	554871	554871	554871
(12) Piece, packing . . . . .	553537	—	—	—	—	—	—	—
(13) §Light unit . . . . .	553948	553948	—	—	553921	553921	555447	555447
(14) Spring, light unit fixing . . . . .	—	—	—	—	—	—	—	—
(15) Screw, plate fixing . . . . .	—	—	—	—	—	—	—	—
(16) Screw, pivot . . . . .	—	—	—	—	—	—	—	—
(17) Pivot . . . . .	—	—	—	—	—	—	—	—
(18) §Bulb holder . . . . .	562303	562303	553724	553724	554602	554602	554602	554602
(19) § Sleeve, terminal . . . . .	555910	555910	—	—	555910	555910	555910	555910
(20) § Interior, pilot bulb holder . . . . .	—	—	—	—	—	—	—	—
(21) §Backshell . . . . .	‡552943	‡552943	—	—	—	—	—	—
(22) Clip and screw, adaptor . . . . .	562306	562306	—	—	—	—	—	—
(23) §Bulb, main . . . . .	—	—	—	—	354	414	355	355
(24) §Buffer, rubber . . . . .	—	—	—	—	—	—	—	—
(25) Conversion adaptor . . . . .	—	—	—	—	—	—	—	—
(26) §Gasket, rubber . . . . .	554280	554280	554280	554280	554279	554279	554279	554279
(27) Screw, with washer . . . . .	554288	554288	554288	554288	554288	554288	554288	554288
(28) Spring, trimmer . . . . .	552813	552813	552813	552813	552813	552813	552813	552813
(29) Sleeve, sealing . . . . .	554626	554626	554626	554626	554626	554626	554626	554626
(30) Screw, body fixing . . . . .	—	—	—	—	—	—	—	—
(31) Body . . . . .	—	—	—	—	—	—	—	—

Part No. . . . .	†51393A	†51394A	†51407A	†51408A	†51409A	51411A	51411B/D	†51414A
Model . . . . .	F700EF	F700	F700	F700	F700	F700EF	F700EF	F700EF
Finish . . . . .	—	—	C.P.R.	C.P.R.	C.P.R.	C.P.R.	C.P.R.	C.P.R.
Replaced by (see footnote) . . . . .	(51411)	(51467)	(51344)	(51346)	(51533)	—	—	(51411)
(1) §Rim or door . . . . .	552912	552912	554439	554439	554439	554439	554439	554439
(2) § Screw, rim fixing . . . . .	552816	552816	116141	116141	116141	116141	198898	116141
(3) Washer, screw retaining . . . . .	—	—	161385	161385	161385	161385	161385	161385
(4) Motif, top front . . . . .	—	—	—	—	—	—	—	—
(5) Screw, bracket and motif fixing . . . . .	—	—	—	—	—	—	—	—
(6) Bracket, rim and motif fixing . . . . .	—	—	554240	554240	554240	554240	555704	554240
(7) Nut, rim fixing screw . . . . .	—	—	—	—	—	—	187117	—
(8) §Excluder, dust . . . . .	552906	552906	552906	552906	552906	552906	552906	552906
(9) §Plate, light unit retaining . . . . .	554872	554872	554872	554872	554872	554872	554872	554872
(10) Screw, unit rim . . . . .	186137	186137	186137	186137	186137	186137	186137	186137
(11) Rim, unit seating . . . . .	554871	554871	554871	554871	554871	554871	554871	554871
(12) Piece, packing . . . . .	553537	553537	553537	553537	553537	553537	553537	553537
(13) §Light unit . . . . .	553948	—	553921	553940	555447	553948	553948	553948
(14) Spring, light unit fixing . . . . .	—	—	—	—	—	—	—	—
(15) Screw, plate fixing . . . . .	—	—	—	—	—	—	—	—
(16) Screw, pivot . . . . .	—	—	—	—	—	—	—	—
(17) Pivot . . . . .	—	—	—	—	—	—	—	—
(18) §Bulb holder . . . . .	562303	553724	554602	554602	554602	562303	562303	562303
(19) § Sleeve, terminal . . . . .	555910	555910	555910	555910	555910	555910	555910	555910
(20) § Interior, pilot bulb holder . . . . .	—	—	—	—	—	—	—	—
(21) §Backshell . . . . .	‡552943	—	—	—	—	‡552943	‡552943	‡552943
(22) Clip and screw, adaptor . . . . .	562306	—	—	—	—	562306	562306	562306
(23) §Bulb, main . . . . .	—	—	354	370	355	—	—	—
(24) §Buffer, rubber . . . . .	—	—	—	—	—	—	—	—
(25) Conversion adaptor . . . . .	—	—	—	—	—	—	—	—
(26) §Gasket, rubber . . . . .	553561	553561	554279	554279	554279	554279	554279	554279
(27) Screw, with washer . . . . .	554288	554288	554288	554288	554288	554288	554288	554288
(28) Spring, trimmer . . . . .	552813	552813	552813	552813	552813	552813	552813	552813
(29) Screw, motif fixing . . . . .	—	—	—	—	—	—	—	—
(30) Sleeve, sealing . . . . .	554626	554626	554626	554626	554626	554626	554626	554626
(31) Screw, body fixing . . . . .	—	—	—	—	—	—	—	—
(32) Pin, split . . . . .	—	—	—	—	—	—	—	—

For illustrations, see pages G25-G29

Note. For replacement lamp spare parts, see appropriate column under part number  
 ‡ Supplied complete with Adaptor 562303 § Recommended spares for stock

† When ordering, quote part number shown in brackets  
 C.P.R. . . Chromium plated rim

# HEADLAMPS, Flush Fitting

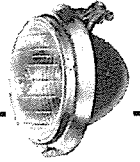

## DETAILED SPARE PARTS

51346A F700 C.P.R. —	51346B/E F700 C.P.R. —	51369A F700P C.P.R. —	51370A F700P C.P.R. —	51371A F700P C.P.R. —	†51378A F700 C.P.R. (51344)	†51380A F700 C.P.R. (51533)	†51382A F700 C.P.R. (51346)	51382B/E F700 —	†51391A F700 — (51533)	†51392A F700 — (51346)	
554439	554439	552936	552936	552936	554439	554439	554439	554439	552912	552912	(1)
116141	198898	552816	552816	552816	116141	116141	116141	198898	552816	552816	(2)
161385	161385	—	—	—	161385	161385	161385	161385	—	—	(3)
—	—	—	—	—	—	—	—	—	—	—	(4)
—	—	—	—	—	—	—	—	—	—	—	(5)
554240	555704	—	—	—	554240	554240	554240	555704	—	—	(6)
—	187117	—	—	—	—	—	—	187117	—	—	(7)
552906	552906	552906	552906	552906	552906	552906	552906	552906	552906	552906	(8)
554872	554872	554872	554872	554872	554872	554872	554872	554872	554872	554872	(9)
186137	186137	186137	186137	186137	186137	186137	186137	186137	186137	186137	(10)
554871	554871	554871	554871	554871	554871	554871	554871	554871	554871	554871	(11)
—	—	553537	553537	553537	—	—	—	—	553537	553537	(12)
553940	553940	553921	555447	553940	553921	555447	553940	553940	555447	553940	(13)
—	—	—	—	—	—	—	—	—	—	—	(14)
—	—	—	—	—	—	—	—	—	—	—	(15)
—	—	—	—	—	—	—	—	—	—	—	(16)
—	—	—	—	—	—	—	—	—	—	—	(17)
554602	554602	554603	554603	554603	554602	554602	554602	554602	554602	554602	(18)
555910	555910	555910	555910	555910	555910	555910	555910	555910	555910	555910	(19)
—	—	553780	553780	553780	—	—	—	—	—	—	(20)
—	—	—	—	—	—	—	—	—	—	—	(21)
—	—	—	—	—	—	—	—	—	—	—	(22)
370	370	354 ‡222	355 ‡222	370 ‡222	354	355	370	370	355	370	(23)
—	—	—	—	—	—	—	—	—	—	—	(24)
—	—	—	—	—	—	—	—	—	—	—	(25)
554279	554279	553561	553561	553561	554279	554279	554279	554279	553561	553561	(26)
554288	554288	554288	554288	554288	554288	554288	554288	554288	—	554288	(27)
552813	552813	552813	552813	552813	552813	552813	552813	552813	552813	552813	(28)
554626	554626	—	—	—	554626	554626	554626	554626	554626	554626	(29)
—	—	—	—	—	—	—	—	—	—	—	(30)
—	—	—	—	—	—	—	—	—	—	—	(31)

51417A F700 C.P.R. —	†51418A F700 C.P.R. (51530)	51419A F700 C.P.R. —	51420A F700EF C.P.R. —	51422A RF770EF C.P.R. —	51423A RF770EF C.P.R. —	†51426A F700 C.P.R. (51504)	51462A RF770 C.P.R. —	B51462A RF770 C.P.R. —	51464A RF770EF C.P.R. —	51467A F700 C.P.R. —	
554690	554690	554690	554690	553996	553996	554225	553996	553996	553996	554439	(1)
116141	116141	116141	116141	554582	554582	554222	554582	554582	554582	116141	(2)
161385	161385	161385	161385	—	—	—	—	—	—	161385	(3)
554684	554684	554684	554684	553967	553967	—	553967	553967	553967	—	(4)
—	—	—	—	116003	116003	—	116003	116003	116003	—	(5)
554240	554240	554240	554240	553953	553953	—	553953	553953	553953	554240	(6)
—	—	—	—	—	—	—	—	—	—	—	(7)
552906	552906	552906	552906	553954	553954	552906	553954	553954	553954	552906	(8)
554872	554872	554872	554872	553878	553878	554179	553878	553878	553878	554872	(9)
186137	186137	186137	186137	186137	186137	186134	186137	186137	186137	186137	(10)
554871	554871	554871	554871	553877	553877	554175	553877	553877	553877	554871	(11)
—	—	—	—	—	—	—	—	—	—	—	(12)
553921	555447	553940	553948	553476	553627	—	553476	553476	553476	—	(13)
—	—	—	—	—	—	*554180	—	—	—	—	(14)
—	—	—	—	—	—	—	—	—	—	—	(15)
—	—	—	—	—	—	—	—	—	—	—	(16)
—	—	—	—	—	—	—	—	—	—	—	(17)
554602	554602	554602	562303	562303	562303	553724	554602	554602	562303	553724	(18)
555910	555910	555910	555910	555190	555910	—	555910	555910	555910	—	(19)
—	—	—	—	—	—	—	—	—	—	—	(20)
—	—	—	§552943	§552943	§552943	—	553480	553480	§552943	—	(21)
—	—	—	562306	562306	562306	—	—	—	562306	—	(22)
354	355	370	—	553875	553875	—	323	370	553875	—	(23)
—	—	—	—	—	—	—	553875	553875	553875	—	(24)
—	—	—	—	—	—	—	—	—	—	—	(25)
554683	554683	554683	554683	—	—	554178	—	—	—	554279	(26)
554288	554288	554288	554288	*552708	*552708	554182	*552708	*552708	*552708	554288	(27)
552813	552813	552813	552813	553872	553872	554202	553872	553872	553872	552813	(28)
—	—	—	—	—	—	—	—	—	—	—	(29)
554626	554626	554626	554626	554626	554626	—	554626	554626	554626	554626	(30)
—	—	—	—	117020	117020	—	117020	117020	117020	—	(31)
—	—	—	—	—	—	—	—	—	—	—	(32)

For illustrations, see pages G25–G29

\* See Supersession Chart † When ordering, quote part number shown in brackets ‡ Pilot § Supplied complete with Adaptor 562303 C.P.R. ... Chromium plated rim ¶ Rim plate ¶ Unit rim retaining continued

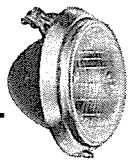

# HEADLAMPS, Flush Fitting

## DETAILED SPARE PARTS

Part No. . . . .	51467B/D	51468A	51468B	51468D/H	51469A/B	51469D	51469E/J	51470A
Model . . . . .	F700	F700	F700	F700	F700	F700	F700	F700
Finish . . . . .	C.P.R.	—	—	—	—	—	—	—
Replaced by (see footnote)	—	—	—	—	—	—	—	—
(1) §Rim or door . . . . .	554439	—	—	—	—	—	—	—
(2) § Screw, rim fixing . . . . .	198898	—	—	—	—	—	—	—
(3) Washer, screw retaining . . . . .	161385	—	—	—	—	—	—	—
(4) Motif, top front . . . . .	—	—	—	—	—	—	—	—
(5) Screw, bracket and motif fixing . . . . .	—	—	—	—	—	—	—	—
(6) Bracket, rim and motif fixing . . . . .	555704	554240	555704	—	554240	555704	—	554240
(7) §Nut, rim fixing screw . . . . .	187117	—	187117	—	—	187117	—	—
(8) §Excluder, dust . . . . .	552906	552906	552906	552906	552906	552906	552906	552906
(9) §Plate, light unit retaining . . . . .	554872	554872	554872	554872	554872	554872	554872	554872
(10) Screw, unit rim . . . . .	186137	186137	186137	186137	186137	186137	186137	186137
(11) Rim, unit seating . . . . .	554871	554871	554871	554871	554871	554871	554871	554871
(12) Piece, packing . . . . .	—	—	—	—	—	—	—	—
(13) §Light unit . . . . .	—	553921	553921	553921	555447	555447	555447	553940
(14) Spring, light unit fixing . . . . .	—	—	—	—	—	—	—	—
(15) Screw, plate fixing . . . . .	—	—	—	—	—	—	—	—
(16) Screw, pivot . . . . .	—	—	—	—	—	—	—	—
(17) Pivot . . . . .	—	—	—	—	—	—	—	—
(18) §Bulb holder . . . . .	553724	554602	554602	554602	554602	554602	554602	554602
(19) § Sleeve, terminal . . . . .	—	555910	555910	555910	555910	555910	555910	555910
(20) § Interior, pilot bulb holder . . . . .	—	—	—	—	—	—	—	—
(21) §Backshell . . . . .	—	—	—	—	—	—	—	—
(22) Clip and screw, adaptor . . . . .	—	—	—	—	—	—	—	—
(23) §Bulb, main . . . . .	—	354	354	354	355	355	355	370
(24) §Buffer, rubber . . . . .	—	—	—	—	—	—	—	—
(25) Conversion adaptor . . . . .	—	—	—	—	—	—	—	—
(26) §Gasket, rubber . . . . .	554279	554280	555415	554280	554280	555415	554280	554280
(27) Screw, with washer . . . . .	554288	554288	554288	554288	554288	554288	554288	554288
(28) Spring, trimmer . . . . .	552813	552813	552813	552813	552813	552813	552813	552813
(29) Screw, motif fixing . . . . .	—	—	—	—	—	—	—	—
(30) Sleeve, sealing . . . . .	554626	554626	554626	554626	554626	554626	554626	554626
(31) Screw, body fixing . . . . .	—	—	—	—	—	—	—	—

Part No. . . . .	51482A	51483A	51484A	51490A/B	51490D/J	51492A	51492B/H	51493A
Model . . . . .	PF770	PF770	PF770EF	F700	F700	F700	F700	RF770
Finish . . . . .	C.P.R.	C.P.R.	C.P.R.	C.P.R.	C.P.R.	C.P.R.	C.P.R.	C.P.R.
Replaced by (see footnote)	—	—	—	—	—	—	—	—
(1) §Rim or door . . . . .	553978	553978	553978	554440	554440	554440	554440	553996
(2) § Screw, rim fixing . . . . .	554582	554582	554582	116141	198898	116141	198898	554582
(3) Washer, screw retaining . . . . .	—	—	—	161385	161385	161385	161385	—
(4) Motif, top front . . . . .	553980	553980	553980	—	—	—	—	553967
(5) Screw, bracket and motif fixing . . . . .	116003	116003	116003	—	—	—	—	116003
(6) Bracket, rim and motif fixing . . . . .	553953	553953	553953	554240	555704	554240	555704	553953
(7) §Nut, rim fixing screw . . . . .	—	—	—	—	187117	—	187117	—
(8) §Excluder, dust . . . . .	553954	553954	553954	552906	552906	552906	552906	553954
(9) §Plate, light unit retaining . . . . .	553971	553971	553971	554872	554872	554872	554872	553971
(10) Screw, unit rim . . . . .	186137	186137	186137	186137	186137	186137	186137	186137
(11) Rim, unit seating . . . . .	553972	553972	553972	554871	554871	554871	554871	553972
(12) §Light unit . . . . .	555447	553940	553948	555447	555447	553940	553940	554308
(13) Spring, light unit fixing . . . . .	—	—	—	—	—	—	—	—
(14) Screw, plate fixing . . . . .	—	—	—	—	—	—	—	—
(15) §Bulb holder . . . . .	554602	554602	562303	554602	554602	554602	554602	554602
(16) § Sleeve, terminal . . . . .	555910	555910	555910	555910	555910	555910	555910	555910
(17) §Backshell . . . . .	—	—	‡552943	—	—	—	—	—
(18) Clip and screw, adaptor . . . . .	—	—	562306	—	—	—	—	—
(19) §Bulb, main . . . . .	355	370	—	332	332	336	336	354
(20) Conversion adaptor . . . . .	—	—	—	—	—	—	—	—
(21) §Gasket, rubber . . . . .	553955	553955	553955	554280	554280	554280	554280	—
(22) Screw, with washer . . . . .	*552708	*552708	*552708	554288	554288	554288	554288	*552708
(23) Spring, trimmer . . . . .	553872	553872	553872	552813	552813	552813	552813	553872
(24) Screw, motif or boss fixing . . . . .	—	—	—	—	—	—	—	—
(25) Washer, spring . . . . .	—	—	—	—	—	—	—	—
(26) Sleeve, sealing . . . . .	554626	554626	554626	554626	554626	554626	554626	554626
(27) Motif . . . . .	—	—	—	—	—	—	—	—
(28) Screw, body fixing . . . . .	—	—	117020	—	—	—	—	117020
(29) Pin, split . . . . .	—	—	—	—	—	—	—	—
(30) Grommet, medallion . . . . .	—	—	—	—	—	—	—	—
(31) Shield, bulb . . . . .	—	—	—	—	—	—	—	—
(32) Washer, cable grip . . . . .	—	—	—	—	—	—	—	—

For illustrations, see pages G25–G29

Note. For replacement lamp spare parts, see appropriate column under part number  
 § Recommended spares for stock C.P.R. . . . Chromium plated rim

\* See Supersession Chart

‡ Supplied complete with Adaptor 562303

# HEADLAMPS, Flush Fitting

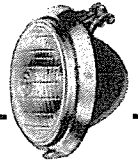

## DETAILED SPARE PARTS

51470B F700	51470D/H F700	51471A F700EF	51471B F700	51471D/E F700	51472A PF770 C.P.R.	51477A F700 C.P.R.	51477B/H F700 C.P.R.	51478A PF770 C.P.R.	51479A PF770 C.P.R.	51480A PF770 C.P.R.	
—	—	—	—	—	—	—	—	—	—	—	
—	—	—	—	—	553956	554440	554440	553620	553956	553620	(1)
—	—	—	—	—	552796	116141	198898	552796	552796	552796	(2)
—	—	—	—	—	—	161385	161385	—	—	—	(3)
—	—	—	—	—	553864	—	—	553623	553864	553623	(4)
—	—	—	—	—	116003	—	—	116003	116003	116003	(5)
555704	—	554240	555704	—	553953	554240	555704	552691	553953	552691	(6)
187117	—	—	187117	—	—	—	187117	—	—	—	(7)
552906	552906	552906	552906	552906	553954	552906	552906	—	553954	—	(8)
554872	554872	554872	554872	554872	553971	554872	554872	554596	553971	554596	(9)
186137	186137	186137	186137	186137	186137	186137	186137	—	186137	—	(10)
554871	554871	554871	554871	554871	553972	554871	554871	553614	553972	553614	(11)
—	—	—	—	—	—	—	—	—	—	—	(12)
553940	553940	553948	553949	553949	554665	553921	553921	554665	553940	553940	(13)
—	—	—	—	—	—	—	—	—	—	—	(14)
—	—	—	—	—	—	—	—	101970	—	101970	(15)
—	—	—	—	—	—	—	—	100329	—	100329	(16)
—	—	—	—	—	—	—	—	552444	—	552444	(17)
554602	554602	562303	562303	562303	554602	554602	554602	554602	554602	554602	(18)
555910	555910	555910	555910	555910	555910	555910	555910	555910	555910	555910	(19)
—	—	—	—	—	—	—	—	—	—	—	(20)
—	—	‡552943	‡552943	‡552943	—	—	—	—	—	—	(21)
—	—	562306	562306	562306	—	—	—	—	—	—	(22)
370	370	—	—	—	370	359	359	370	350	370	(23)
—	—	—	—	—	—	—	—	—	—	—	(24)
—	—	—	—	—	—	—	—	—	—	—	(25)
555415	554280	554280	555415	554280	553955	554280	554280	552688	553955	552688	(26)
554288	554288	554288	554288	554288	*552708	554288	554288	554288	*552708	554288	(27)
552813	552813	552813	552813	552813	553872	552813	552813	552813	553872	552813	(28)
—	—	—	—	—	—	—	—	—	—	—	(29)
554626	554626	554626	554626	554626	554626	554626	554626	—	554626	—	(30)
—	—	—	—	—	—	—	—	117020	—	117020	(31)

51495A PF770 C.P.R.	51496A/B F700 C.P.R.	51496D/H F700 C.P.R.	51498A/B F700 C.P.R.	51498D/H F700 C.P.R.	51500A F700 C.P.R.	51500B/E F700 C.P.R.	51504A F700 C.P.R.	†51505A J700 C.P.R. (51762)	†51506A J700 C.P.R. (51763)	51507A PF700 C.P.R.	
—	—	—	—	—	—	—	—	—	—	—	
553978	554440	554440	554440	554440	554440	554440	554225	554903	554903	554903	(1)
554582	116141	198898	116141	198898	116141	198898	554222	552796	552796	552796	(2)
—	161385	161385	161385	161385	161385	161385	—	—	—	—	(3)
553980	—	—	—	—	—	—	—	554905	554905	554905	(4)
116003	—	—	—	—	—	—	—	116003	116003	116003	(5)
553953	554240	555704	554240	555704	554240	555704	—	552691	552691	552691	(6)
—	—	187117	—	187117	—	187117	—	—	—	—	(7)
553954	552906	552906	552906	552906	552906	552906	552906	554459	554459	554459	(8)
553971	554872	554872	554872	554872	554872	554872	554179	554906	554906	554906	(9)
186137	186137	186137	186137	186137	186137	186137	186134	186137	186137	186137	(10)
553972	554871	554871	554871	554871	554871	554871	554175	554907	554907	554907	(11)
555447	553921	553921	555447	555447	553940	553940	—	555709	555710	554917	(12)
—	—	—	—	—	—	—	¶554180	¶554488	¶554488	§554923	(13)
—	—	—	—	—	—	—	—	**554909	**554909	—	(14)
553724	554602	554602	554602	554602	554602	554602	861216	54520187	54520187	554602	(15)
—	555910	555910	555910	555910	555910	555910	—	—	—	555910	(16)
—	—	—	—	—	—	—	—	—	—	—	(17)
—	—	—	—	—	—	—	—	—	—	—	(18)
355	373	373	357	357	403	403	—	404	406	370	(19)
554691	—	—	—	—	—	—	—	—	—	—	(20)
553955	554280	554280	554280	554280	554280	554280	554178	553955	553955	553955	(21)
*552708	554288	554288	554288	554288	554288	554288	554182	*552708	*552708	*552708	(22)
553872	552813	552813	552813	552813	552813	552813	554202	553872	553872	553872	(23)
—	—	—	—	—	—	—	—	132464	132464	132464	(24)
—	—	—	—	—	—	—	—	188341	188341	188412	(25)
554626	554626	554626	554626	554626	554626	554626	—	554626	554626	554626	(26)
—	—	—	—	—	—	—	—	554914	554914	—	(27)
—	—	—	—	—	—	—	—	117020	117020	117020	(28)
117020	—	—	—	—	—	—	186761	††555587	††555587	—	(29)
—	—	—	—	—	—	—	—	554918	554918	—	(30)
—	—	—	—	—	—	—	—	554912	554912	—	(31)
—	—	—	—	—	—	—	—	553568	553568	553568	(32)

For illustrations, see pages G25–G29

\* See Supersession Chart † When ordering, quote part number shown in brackets ‡ Supplied complete with Adaptor 562303 ¶ Unit rim retaining †† continued  
 †† Spring, adaptor\_shell retaining § Boss \*\* Shell, adaptor ††† Plate mask C.P.R. ... Chromium plated rim

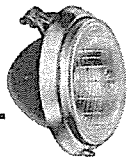

# HEADLAMPS, Flush Fitting

## DETAILED SPARE PARTS

Part No. . . . .	51509A/B	51509D/H	51515F/J	51516A/K	51517A/J	51518A/H	51529A	51530A
Model . . . . .	F700	F700	F700	F700	F700	F700EF	F700	F700
Finish . . . . .	C.P.R.	C.P.R.	C.P.R.	C.P.R.	C.P.R.	C.P.R.	—	C.P.R.
Replaced by (see footnote) . . . . .	—	—	—	—	—	—	—	—
(1) §Rim or door . . . . .	554440	554440	554982	554982	554982	554982	552949	554690
(2) § Screw, rim fixing . . . . .	116141	198898	554983	554983	554983	554983	552816	116141
(3) Washer, screw retaining . . . . .	161385	161385	161385	161385	161385	161385	—	161385
(4) Motif, top front . . . . .	—	—	—	—	—	—	‡552995	‡554684
(5) Screw, bracket and motif fixing . . . . .	—	—	—	—	—	—	—	—
(6) Bracket, rim and motif fixing . . . . .	554240	555704	—	—	—	—	—	554240
(7) §Nut, rim fixing screw . . . . .	—	187117	—	—	—	—	—	—
(8) §Excluder, dust . . . . .	552906	552906	552906	552906	552906	552906	552906	552906
(9) §Plate, light unit retaining . . . . .	554872	554872	554872	554872	554872	554872	554872	554872
(10) Screw, unit rim . . . . .	186137	186137	186137	186137	186137	186137	186137	186137
(11) Rim, unit seating . . . . .	554871	554871	554871	554871	554871	554781	554871	554871
(12) §Light unit . . . . .	555447	555447	553921	555447	553940	553948	553940	555447
(13) Spring, light unit fixing . . . . .	—	—	—	—	—	—	—	—
(14) Screw, plate fixing . . . . .	—	—	—	—	—	—	—	—
(15) §Bulb holder . . . . .	553724	553724	554602	554602	554602	562303	553724	553724
(16) § Sleeve, terminal . . . . .	—	—	555910	555910	555910	555910	—	—
(17) §Backshell . . . . .	—	—	—	—	—	¶552943	—	—
(18) Clip and screw, adaptor . . . . .	—	—	—	—	—	562306	—	—
(19) §Bulb, main . . . . .	355	355	354	355	370	—	370	355
(20) Conversion adaptor . . . . .	554691	554691	—	—	—	—	554691	554691
(21) §Gasket, rubber . . . . .	554280	554280	554279	554279	554279	554279	552996	554683
(22) Screw, with washer . . . . .	554288	554288	554288	554288	554288	554288	554288	554288
(23) Spring, trimmer . . . . .	552813	552813	552813	552813	552813	552813	552813	552813
(24) Screw, motif or boss fixing . . . . .	—	—	—	—	—	—	—	—
(25) Washer, spring . . . . .	—	—	—	—	—	—	—	—
(26) Motif . . . . .	—	—	—	—	—	—	—	—
(27) Screw, body fixing . . . . .	—	—	—	—	—	—	—	—
(28) Pin, split . . . . .	—	—	—	—	—	—	—	—
(29) Nut, barrel . . . . .	—	—	—	—	—	—	—	—
(30) Shield, bulb . . . . .	—	—	—	—	—	—	—	—
(31) Sleeve, sealing . . . . .	554626	554626	554626	554626	554626	554626	554626	554626
(32) Washer, cable grip . . . . .	—	—	—	—	—	—	—	—

Part No. . . . .	51546A	51546B/E	51553A	51560A	51561A	51562B	51563A/B	51564A/B
Model . . . . .	P700	P700	PF770-LR	PF770-LR	PF770EF	PF700	PF700	PF700
Finish . . . . .	C.P.R.	C.P.R.	C.P.R.	C.P.R.	C.P.R.	C.P.R.	C.P.R.	C.P.R.
Replaced by (see footnote) . . . . .	—	—	—	—	—	—	—	—
(1) §Rim or door . . . . .	554440	554440	553978	553978	553978	554903	554903	554903
(2) § Screw, rim fixing . . . . .	116141	198898	554582	552796	552796	552796	552796	552796
(3) Washer, screw retaining . . . . .	161385	161385	—	—	—	—	—	—
(4) Motif, top front . . . . .	—	—	553980	553980	553980	554905	554905	554905
(5) Screw, bracket and motif fixing . . . . .	—	—	116003	116003	116003	116003	116003	116003
(6) Bracket, rim and motif fixing . . . . .	554240	555704	553953	553953	553953	552691	552691	552691
(7) §Nut, rim fixing screw . . . . .	—	187117	—	—	—	—	—	—
(8) §Excluder, dust . . . . .	552906	552906	553954	553954	553954	554459	554459	554459
(9) §Plate, light unit retaining . . . . .	554872	554872	553971	553971	553971	554906	554906	554906
(10) Screw, unit rim . . . . .	186137	186137	186137	186137	186137	186137	186137	186137
(11) Rim, unit seating . . . . .	554871	554871	553972	553972	553972	554907	554907	554907
(12) Piece, packing . . . . .	—	—	—	—	553537	—	—	—
(13) §Light unit . . . . .	554999	554999	554665	554665	555288	—	555288	554665
(14) §Bulb holder . . . . .	54520187	54520187	554602	554602	562303	553724	562303	554602
(15) § Sleeve, terminal . . . . .	555910	—	555910	555910	555910	—	555910	555910
(16) § Interior, pilot bulb holder . . . . .	—	—	—	—	—	—	—	—
(17) §Backshell . . . . .	¶554909	¶554909	—	—	¶552943	—	¶552943	—
(18) Clip and screw, adaptor . . . . .	§534488	§534488	—	—	562306	—	562306	—
(19) §Bulb, main . . . . .	404	404	370	370	—	—	—	350
(20) §Buffer, rubber . . . . .	—	—	—	—	—	—	—	—
(21) Conversion adaptor . . . . .	—	—	—	—	—	—	—	—
(22) §Gasket, rubber . . . . .	554280	554280	553955	553955	553955	553955	553955	553955
(23) Screw, with washer . . . . .	554288	554288	*552708	*552708	*552708	*552708	*552708	*552708
(24) Spring, trimmer . . . . .	552813	552813	553872	553872	553872	553872	553872	553872
(25) Screw, motif or boss fixing . . . . .	—	—	—	—	—	—	—	—
(26) Washer, spring . . . . .	—	—	—	—	—	—	—	—
(27) Motif . . . . .	—	—	—	—	—	—	—	—
(28) Screw, body fixing . . . . .	—	—	117020	117020	117020	117020	117020	117020
(29) Sleeve, sealing . . . . .	554626	554626	554626	554626	554626	554626	554626	554626
(30) Washer, cable grip . . . . .	—	—	553568	553568	—	553568	—	553568
(31) Pin, split . . . . .	—	—	—	—	—	—	—	—

For illustrations, see pages G25-G29

Note. For replacement lamp spare parts, see appropriate column under part number \* See Supersession Chart ‡ Rim plate § Recommended spares for stock  
 ¶ Shell, adaptor ¶ Supplied complete with Adaptor 562303 § Spring, adaptor shell retaining

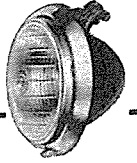

# HEADLAMPS, Flush Fitting

## DETAILED SPARE PARTS

51533A/B F700 C.P.R.	51533D/F F700 C.P.R.	51534B/E F700 C.P.R.	51535A F700-LR C.P.R.	51535B/F F700 C.P.R.	†51536A F700 C.P.R.	51536B F700 C.P.R.	51537A F700-LR C.P.R.	51537B/D F700 C.P.R.	51538A P700 C.P.R.	51538B/E P700 C.P.R.	
554439	554439	554439	554440	554440	554440	554440	554690	554690	554439	554439	(1)
116141	198898	198898	116141	198898	116141	198898	116141	198898	116141	198898	(2)
161385	161385	161385	161385	161385	161385	161385	161385	161385	161385	161385	(3)
—	—	—	—	—	—	—	‡554684	‡554684	—	—	(4)
—	—	—	—	—	—	—	—	—	—	—	(5)
554240	555704	555704	554240	555704	554240	555704	554240	555704	554240	555704	(6)
—	187117	187117	—	187117	—	187117	—	187117	—	187117	(7)
552906	552906	552906	552906	552906	552906	552906	552906	552906	552906	552906	(8)
554872	554872	554872	554872	554872	554872	554872	554872	554872	554872	554872	(9)
186137	186137	186137	186137	186137	186137	186137	186137	186137	186137	186137	(10)
554871	554871	554871	554871	554871	554871	554871	554871	554871	554871	554871	(11)
555447	555447	554665	554665	554665	553940	553940	554665	554665	554308	554308	(12)
—	—	—	—	—	—	—	—	—	—	—	(13)
—	—	—	—	—	—	—	—	—	—	—	(14)
553724	553724	554602	554602	554602	554602	554602	554602	554602	554602	554602	(15)
—	—	555910	555910	555910	555910	555910	555910	555910	555910	555910	(16)
—	—	—	—	—	—	—	—	—	—	—	(17)
—	—	—	—	—	—	—	—	—	—	—	(18)
355	355	370	370	370	350	350	370	370	354	414	(19)
554691	544691	—	—	—	—	—	—	—	—	—	(20)
554279	554279	554279	554280	554280	554280	555415	554683	554683	554279	554279	(21)
554288	554288	554288	554288	554288	554288	554288	554288	554288	554288	554288	(22)
552813	552813	552813	552813	552813	552813	552813	552813	552813	552813	552813	(23)
—	—	—	—	—	—	—	—	—	—	—	(24)
—	—	—	—	—	—	—	—	—	—	—	(25)
—	—	—	—	—	—	—	—	—	—	—	(26)
—	—	—	—	—	—	—	—	—	—	—	(27)
—	—	—	—	—	—	—	—	—	—	—	(28)
—	—	—	—	—	—	—	—	—	—	—	(29)
—	—	—	—	—	—	—	—	—	—	—	(30)
554626	554626	554626	554626	554626	554626	554626	554626	554626	554626	554626	(31)
—	—	—	—	—	—	—	—	—	—	—	(32)

51565B PF770 C.P.R.	51587H F700 C.P.R.	†51590A F700EF C.P.R. (51342)	51590B/E F700EF C.P.R.	51591A F700LR-EF C.P.R.	51591B/E F700LR-EF C.P.R.	51592E/H F700P C.P.R.	51596A P700 C.P.R.	51602A/R F700 C.P.R.	51603A/Q F700 C.P.R.	51604A/M F700 C.P.R.	
554903	—	554440	554440	554440	554440	554440	554440	555326	555326	555326	(1)
552796	—	116141	198898	116141	198898	198898	116141	101750	101750	101750	(2)
—	—	161385	161385	161385	161385	161385	161385	161385	161385	161385	(3)
554905	—	—	—	—	—	—	—	—	—	—	(4)
116003	—	—	—	—	—	—	—	—	—	—	(5)
552691	555704	554240	555704	554240	555704	555704	—	554240	554240	554240	(6)
—	187117	—	187117	—	187117	187117	—	—	—	—	(7)
554459	—	552906	552906	552906	552906	552906	552906	555333	555333	555333	(8)
554906	554872	554872	554872	554872	554872	554872	554872	555351	555351	555351	(9)
186137	186137	186137	186137	186137	186137	186137	186137	186137	186137	186137	(10)
554907	554871	554871	554871	554871	554871	554871	554871	554871	554871	554871	(11)
—	—	553537	553537	553537	553537	—	—	—	—	—	(12)
554665	—	553948	553948	555288	555288	555309	554308	555423	555424	554917	(13)
554602	553724	562303	562303	562303	562303	554602	554602	54945782	54945782	554602	(14)
555910	—	555910	555910	555910	555910	555910	555910	—	—	555910	(15)
—	—	—	—	—	—	553780	—	—	—	—	(16)
—	—	‡552943	‡552943	‡552943	‡552943	‡554710	—	—	—	—	(17)
—	—	562306	562306	562306	562306	§554354	—	—	—	—	(18)
370	—	—	—	—	—	**222 414	354	404	406	370	(19)
—	—	—	—	—	—	—	—	—	—	—	(20)
553955	554279	554280	554280	554280	554280	554280	555415	§§555332	§§555332	§§555332	(21)
*552708	554288	554288	554288	554288	554288	554288	554288	554279	554279	554279	(22)
553872	552813	552813	552813	552813	552813	552813	552813	††555328	††555328	††555328	(23)
—	—	—	—	—	—	—	—	553872	553872	553872	(24)
—	—	—	—	—	—	—	—	‡‡555344	‡‡555344	‡‡555344	(25)
—	—	—	—	—	—	—	—	§§556509	§§556509	§§556509	(26)
—	—	—	—	—	—	—	—	—	—	—	(27)
—	—	—	—	—	—	—	—	—	—	—	(28)
117020	—	—	—	—	—	—	—	—	—	—	(29)
554626	554626	554626	554626	554626	554626	554626	554626	554626	554626	554626	(30)
553568	—	—	—	—	—	—	—	°°199002	°°199002	°°199002	(31)

For illustrations, see pages G25-G29

\* See Supersession Chart † When ordering, quote part number shown in brackets ‡ Rim plate § Supplied complete with Adaptor 562303 continued  
‡ Bulb holder, pilot § Ring, pilot bulb holder seating \*\* Pilot †† Screw, special, dip adjusting ‡‡ Screw, adjusting §§ Washer, cupped  
§§ Rubber, sealing °° Grommet C.P.R. ... Chromium plated rim

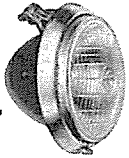

# HEADLAMPS, Flush Fitting

## DETAILED SPARE PARTS

Part No. . . . .		51605A/N F700EF C.P.R.	51606A/R F700 C.P.R.	51607A/L F700 C.P.R.	51639A F700 C.P.R.	51639B/E F700 C.P.R.	51640A F700 C.P.R.	51640B/E F700 C.P.R.	51641A F700 C.P.R.
Replaced by (see footnote)									
(1)	§Rim or door . . . . .	555326	555326	555326	554439	554439	554439	554439	554439
(2)	§ Screw, rim fixing . . . . .	101750	101750	101750	116141	198898	116141	198898	116141
(3)	Washer, screw retaining . . . . .	161385	161385	161385	161385	161385	161385	161385	161385
(4)	Screw, bracket and motif fixing . . . . .	—	—	—	—	—	—	—	—
(5)	Bracket, rim and motif fixing . . . . .	554240	554240	554240	554240	555704	554240	555704	554240
(6)	§Nut, rim fixing screw . . . . .	—	—	—	—	187117	—	187117	—
(7)	§Excluder, dust . . . . .	555333	555333	555333	552906	552906	552906	552906	552906
(8)	§Plate, light unit retaining . . . . .	555351	555351	555351	554872	554872	554872	554872	554872
(9)	Screw, unit rim . . . . .	186137	186137	186137	186137	186137	186137	186137	186137
(10)	Rim, unit seating . . . . .	554871	554871	554871	554871	554871	554871	554871	554871
(11)	Piece, packing . . . . .	553537	—	—	—	—	—	—	—
(12)	§Light unit . . . . .	555355	555447	—	553921	553921	555447	555447	553940
(13)	Spring, light unit fixing . . . . .	—	—	—	—	—	—	—	—
(14)	§Bulb holder . . . . .	555725	54945781	553738	554602	554602	554602	554602	554602
(15)	§ Sleeve, terminal . . . . .	—	—	—	555910	555910	555910	555910	555910
(16)	§ Interior, pilot bulb holder . . . . .	—	—	—	—	—	—	—	—
(17)	§Backshell . . . . .	555968	—	—	—	—	—	—	—
(18)	Clip and screw, adaptor . . . . .	—	—	—	—	—	—	—	—
(19)	§Bulb, main . . . . .	—	355	—	359	359	332	332	336
(20)	§Buffer, rubber . . . . .	‡555332	‡555332	‡555332	—	—	—	—	—
(21)	Conversion adaptor . . . . .	—	554691	—	—	—	—	—	—
(22)	§Gasket, rubber . . . . .	554279	554279	554279	554279	554279	554279	554279	554279
(23)	Screw, with washer . . . . .	‡555328	‡555328	‡555328	554288	554288	554288	554288	554288
(24)	Spring, trimmer . . . . .	553872	553872	553872	552813	552813	552813	552813	552813
(25)	Screw, motif fixing . . . . .	¶555344	¶555344	¶555344	—	—	—	—	—
(26)	Screw, body fixing . . . . .	—	—	—	—	—	—	—	—
(27)	Nut, barrel or fixing bolt . . . . .	—	—	—	—	—	—	—	—
(28)	Washer, cupped . . . . .	556509	556509	556509	—	—	—	—	—
(29)	Base, lamp seating . . . . .	—	—	—	—	—	—	—	—
(30)	Bolt, lamp fixing . . . . .	—	—	—	—	—	—	—	—
(31)	Grommet . . . . .	199002	199002	199002	—	—	—	—	—
(32)	Screw, special adjusting . . . . .	—	—	—	—	—	—	—	—
(33)	§Adaptor plate . . . . .	—	—	—	—	—	—	—	—
(34)	§Gasket, adaptor plate seating . . . . .	—	—	—	—	—	—	—	—
(35)	Sleeve, sealing . . . . .	554626	554626	554626	554626	554626	554626	554626	554626
(36)	Washer, cable grip . . . . .	—	—	—	—	—	—	—	—

Part No. . . . .		51736B/D F700 C.P.R.	51737B F700 C.P.R.	51738A F700 C.P.R.	51738B/D F700 C.P.R.	51739A F700EF C.P.R.	51739B F700EF C.P.R.	51741B F700 C.P.R.	51742B P700 C.P.R.
Replaced by (see footnote)									
(1)	§Rim or door . . . . .	554440	554440	554440	554440	554440	554440	554440	554440
(2)	§ Screw, rim fixing . . . . .	198898	198898	116141	198898	116141	198898	198898	198898
(3)	Washer, screw retaining . . . . .	161385	161385	161385	161385	161385	161385	161385	161385
(4)	Motif, top front . . . . .	—	—	—	—	—	—	—	—
(5)	Screw, bracket and motif fixing . . . . .	—	—	—	—	—	—	—	—
(6)	Bracket, rim and motif fixing . . . . .	555704	555704	554240	555704	554240	555704	555704	555704
(7)	§Nut, rim fixing screw . . . . .	187117	187117	—	187117	—	187117	187117	187117
(8)	§Excluder, dust . . . . .	552906	552906	552906	552906	552906	552906	552906	552906
(9)	§Plate, light unit retaining . . . . .	554872	554872	554872	554872	554872	554872	554872	554872
(10)	Screw, unit rim . . . . .	186137	186137	186137	186137	186137	186137	186137	186137
(11)	Rim, unit seating . . . . .	554871	554871	554871	554871	554871	554871	554871	554871
(12)	Piece, packing . . . . .	—	—	—	—	—	553537	—	—
(13)	§Light unit . . . . .	553921	555447	553940	553940	553948	553948	—	554999
(14)	Spring, light unit fixing . . . . .	—	—	—	—	—	—	—	§534488
(15)	Screw, plate fixing . . . . .	—	—	—	—	—	—	—	—
(16)	Screw, pivot . . . . .	—	—	—	—	—	—	—	—
(17)	§Bulb holder . . . . .	554602	554602	554602	554602	562303	562303	553724	54520187
(18)	§ Sleeve, terminal . . . . .	555910	555910	555910	555910	555910	555910	—	—
(19)	§Backshell . . . . .	—	—	—	—	**552943	**552943	—	554909
(20)	Clip and screw, adaptor . . . . .	—	—	—	—	562306	562306	—	—
(21)	§Bulb, main . . . . .	354	355	370	370	—	—	—	404
(22)	§Gasket, rubber . . . . .	555415	555415	555415	555415	555415	555415	555415	555415
(23)	Screw, with washer . . . . .	554288	554288	554288	554288	554288	554288	554288	554288
(24)	Spring, trimmer . . . . .	552813	552813	552813	552813	552813	552813	552813	552813
(25)	Screw, motif fixing . . . . .	—	—	—	—	—	—	—	—
(26)	Screw, body fixing . . . . .	—	—	—	—	—	—	—	—
(27)	Pin, split . . . . .	—	—	—	—	—	—	—	—
(28)	Sleeve, sealing . . . . .	554626	554626	554626	554626	554626	554626	554626	554626
(29)	Washer, cable grip . . . . .	—	—	—	—	—	—	—	—

For illustrations, see pages G25-G29

Note. For replacement lamp spare parts, see appropriate column under part number †Rubber, sealing § Recommended spares for stock ¶ Screw, special, dip adjusting § Spring, bulb retaining \*\* Supplied complete with adaptor 562303 C.P.R. . . Chromium plated rim



# HEADLAMPS, Flush Fitting

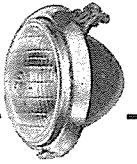

## DETAILED SPARE PARTS

51641B/E F700 C.P.R.	51646A PF700 C.P.R.	†51648A F700 C.P.R. (51640)	†51649A F700 C.P.R. (51641)	†51650A F700 C.P.R. (51639)	51670B/F F700 C.P.R.	51698A/D PF700 C.P.R.	51699B/D PF700 C.P.R.	51700A PF700 C.P.R.	51701A PF700EF C.P.R.	51730A/N F700 C.P.R.	
554439	553965	552912	552912	552912	555475	553965	553965	553965	553965	555326	(1)
198898	552796	552816	552816	552816	198897	552796	552796	552796	552796	101750	(2)
161385	—	161385	161385	161385	161385	—	—	—	—	161385	(3)
—	116003	—	—	—	—	116003	116003	116003	116003	—	(4)
555704	553953	—	—	—	—	553953	553953	553953	553953	554240	(5)
187117	—	—	—	—	187117	—	—	—	—	—	(6)
552906	553954	553752	553752	553752	555477	553954	553954	553954	553954	555333	(7)
554872	553971	554872	554872	554872	554872	553971	553971	553971	553971	555351	(8)
186137	186137	186137	186137	186137	186137	186137	186137	186137	186137	186137	(9)
554871	553972	554871	554871	554871	554871	553972	553972	553972	553972	554871	(10)
—	—	553537	553537	553537	—	—	—	—	553537	—	(11)
553940	555447	553921	555447	553921	553921	554308	555296	553940	553948	555998	(12)
—	—	—	—	—	—	—	—	—	—	—	(13)
554602	553724	554620	554620	554602	554602	554602	554602	554602	562303	54945782	(14)
555910	—	555910	555910	555910	555910	555910	555910	555910	555910	—	(15)
—	—	—	—	—	—	—	—	—	—	—	(16)
—	—	—	—	—	—	—	—	—	‡552943	—	(17)
—	—	—	—	—	—	—	—	—	562306	—	(18)
336	355	332	336	359	414	414	355	370	—	404	(19)
—	—	—	—	—	—	—	—	—	—	—	(20)
—	554691	—	—	—	—	—	—	—	—	—	(21)
554279	553955	—	—	—	554279	553955	553955	553955	553955	554279	(22)
554288	*552708	554288	554288	554288	554288	*552708	*552708	*552708	*552708	—	(23)
552813	553872	552813	552813	552813	552813	553872	553872	553872	553872	553872	(24)
—	—	—	—	—	—	—	—	—	—	—	(25)
—	117020	—	—	—	—	117020	117020	117020	117020	‡555344	(26)
—	—	—	—	—	—	—	—	—	—	—	(27)
—	—	—	—	—	—	—	—	—	—	556509	(28)
—	—	—	—	—	—	—	—	—	—	—	(29)
—	—	—	—	—	—	—	—	—	—	199002	(30)
—	—	—	—	—	—	—	—	—	—	555328	(31)
—	—	—	—	—	—	—	—	—	—	—	(32)
—	—	—	—	—	555541	—	—	—	—	—	(33)
—	—	—	—	—	555547	—	—	—	—	‡555332	(34)
554626	554626	554626	554626	554626	554626	554626	554626	554626	554626	554626	(35)
—	—	—	—	—	—	553568	553568	553568	553568	—	(36)

51752H/M F700 C.P.R.	51762A J700 C.P.R.	51763A J700 C.P.R.	51766B/E F700LR	51767D F700 C.P.R.	51769A MCF575 C.P.R.	51777A/K F700 C.P.R.	51779A/H F700 C.P.R.	†51780A/E F700 C.P.R. (51344)	†51781A/E F700 C.P.R. (51533)	†51782A/D F700 C.P.R. (51346)	
555326	554903	554903	—	554440	516723	555457	555457	554439	554439	554439	(1)
144471	552796	552796	—	198898	516710	198898	198898	198898	198898	198898	(2)
161385	—	—	—	161385	—	161385	161385	161385	161385	161385	(3)
—	554905	554905	—	—	—	—	—	—	—	—	(4)
—	116003	116003	—	—	—	—	—	—	—	—	(5)
554240	552691	552691	555704	555704	516709	555704	555704	555704	555704	555704	(6)
—	—	—	187117	187117	166019	187117	187117	187117	187117	187117	(7)
555333	554459	554459	—	552906	—	552906	552906	552906	552906	552906	(8)
555351	554906	554906	554893	554872	—	554872	554872	554872	554872	554872	(9)
186137	186137	186137	186137	186137	—	186137	186137	186137	186137	186137	(10)
554871	554907	554907	554672	554871	—	554871	554871	554871	554871	554871	(11)
—	—	—	—	—	—	—	—	—	—	—	(12)
555999	555709	555710	554665	555735	516659	553921	—	553921	555447	553940	(13)
—	§555711	§555711	—	—	500291	—	—	—	—	—	(14)
—	132464	132464	—	—	—	—	—	—	—	—	(15)
—	**188412	**188412	—	—	—	—	—	—	—	—	(16)
54945782	554855	554855	554602	554602	554946	554602	553724	554602	554602	554602	(17)
—	—	—	555910	555910	555910	555910	—	555910	555910	555910	(18)
—	—	—	—	—	—	—	—	—	—	—	(19)
—	554909	554909	—	—	—	—	—	—	—	—	(20)
—	††534488	††534488	—	—	—	—	—	—	—	—	(21)
406	404	406	370	354	312	414	—	414	355	370	(22)
554279	553955	553955	554280	555415	—	555458	555458	554279	554279	554279	(23)
‡555332	*552708	*552708	554288	554288	—	554288	554288	554288	554288	554288	(24)
553872	553872	553872	552813	552813	552373	552813	552813	552813	552813	552813	(25)
—	—	—	—	—	—	—	—	—	—	—	(26)
‡‡555328	—	—	—	—	—	—	—	—	—	—	(27)
‡‡555344	117020	117020	—	—	—	—	—	—	—	—	(28)
§199002	—	—	—	—	—	—	—	—	—	—	(29)
554626	554626	554626	554626	554626	—	554626	554626	554626	554626	554626	(30)
—	553568	553568	—	—	—	—	—	—	—	—	(31)

For illustrations, see pages G25-G29

\* See Supersession Chart    † When ordering, quote part number shown in brackets    ‡ Supplied complete with adaptor 562303    †† Spring, backshell fixing    ‡‡ Screw, special, dip adjusting    ††† Screw, adjusting  
 † Rubber, sealing    § Medallion    \*\* Washer, securing screw seating    †††† Spring, backshell fixing    ‡‡‡ Screw, special, dip adjusting    §§ Grommet  
 C.P.R. ... Chromium plate rim

continued

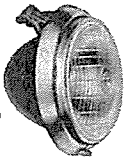

# HEADLAMPS, Flush Fitting

## DETAILED SPARE PARTS

Part No. . . . .	†51783A/B	51784A/B	51785A/H	51791D/E	51792A/E	51794B/H	51795B/F	51796B/E
Model . . . . .	F700EF	F700	F700EF	F700	F700	P700	P700	F700EF
Finish . . . . .	C.P.R.	C.P.R.	C.P.R.	C.P.R.	C.P.R.	C.P.R.	C.P.R.	C.P.R.
Replaced by (see footnote) . . . . .	(51411)	—	—	—	—	—	—	—
(1) §Rim or door . . . . .	554439	554982	555457	554440	554440	555747	555747	555747
(2) § Screw, rim fixing . . . . .	198898	554983	198898	198898	198898	198898	198898	198898
(3) Washer, screw retaining . . . . .	161385	161385	161385	161385	161385	161385	161385	161385
(4) Motif, top front . . . . .	—	—	—	—	—	—	—	—
(5) Screw, bracket and motif fixing . . . . .	—	—	—	—	—	—	—	—
(6) Bracket, rim and motif fixing . . . . .	555704	—	555704	555704	555704	555704	555704	555704
(7) Nut, rim fixing screw . . . . .	187117	—	187117	187117	187117	187117	187117	187117
(8) §Excluder, dust . . . . .	552906	552906	552906	552906	552906	552906	552906	552906
(9) §Plate, light unit retaining . . . . .	554872	554872	554872	554872	554872	554872	554872	554872
(10) Screw, unit rim . . . . .	186137	186137	186137	186137	186137	186137	186137	186137
(11) Rim, unit seating . . . . .	554871	554871	554871	554871	554871	554871	554871	554871
(12) Piece, packing . . . . .	—	—	553537	—	—	—	—	553537
(13) §Light unit . . . . .	553948	—	553948	555745	554665	554308	555296	553948
(14) Spring, light unit fixing . . . . .	—	—	—	—	—	—	—	—
(15) §Bulb holder . . . . .	562303	553738	562303	554602	554602	554602	554602	562303
(16) § Sleeve, terminal . . . . .	555910	555910	555910	555910	555910	555910	555910	555910
(17) § Interior, pilot bulb holder . . . . .	—	—	—	—	—	—	—	—
(18) §Backshell . . . . .	‡552943	—	‡552943	—	—	—	—	‡552943
(19) Clip and screw, adaptor . . . . .	562306	—	562306	—	—	—	—	562306
(20) §Bulb, main . . . . .	—	—	—	355	350	414	355	—
(21) §Buffer, rubber . . . . .	—	—	—	—	—	—	—	—
(22) §Gasket, rubber . . . . .	554279	554279	555458	555415	555415	555458	555458	555458
(23) Screw, with washer . . . . .	554288	554288	554288	554288	554288	554288	554288	554288
(24) Spring, trimmer . . . . .	552813	552813	552813	552813	552813	552813	552813	552813
(25) Motif . . . . .	—	—	—	—	—	—	—	—
(26) Screw, body fixing . . . . .	—	—	—	—	—	—	—	—
(27) Sleeve, sealing . . . . .	554626	554626	554626	554626	554626	554626	554626	554626
(28) §Plate, adaptor . . . . .	—	—	—	—	—	—	—	—
(29) §Gasket, adaptor plate seating . . . . .	—	—	—	—	—	—	—	—
(30) Grommet, cable entry . . . . .	—	—	—	—	—	—	—	—

Part No. . . . .	51883A/B	51884A/B	51886A	51891A/E	†51894A/D	51895A/D	51896A/B	51897A/D
Model . . . . .	F700	F700	F700EF	F700	F700	F700	F700EF	F700
Finish . . . . .	C.P.R.	C.P.R.	C.P.R.	C.P.R.	C.P.R.	C.P.R.	C.P.R.	C.P.R.
Replaced by (see footnote) . . . . .	—	—	—	—	(51897)	—	—	—
(1) §Rim or door . . . . .	554439	554439	554440	554440	555475	555475	555475	555475
(2) § Screw, rim fixing . . . . .	198898	198898	198898	198898	198897	198897	198897	198897
(3) Washer, screw retaining . . . . .	161385	161385	161385	161385	161385	161385	161385	161385
(4) Motif, top front . . . . .	—	—	—	—	—	—	—	—
(5) Screw, bracket and motif fixing . . . . .	—	—	—	—	—	—	—	—
(6) Bracket, rim and motif fixing . . . . .	555704	555704	555704	555704	—	—	—	—
(7) §Nut, rim fixing screw . . . . .	187117	187117	187117	187117	187117	187117	187117	187117
(8) §Excluder, dust . . . . .	552906	552906	552906	552906	555477	555477	555477	555477
(9) §Plate, light unit retaining . . . . .	554872	554872	554872	554872	554872	554872	554872	554872
(10) Screw, unit rim . . . . .	186137	186137	186137	186137	186137	186137	186137	186137
(11) Rim, unit seating . . . . .	554871	554871	554871	554871	554871	554871	554871	554871
(12) Piece, packing . . . . .	—	—	—	—	—	—	—	—
(13) §Light unit . . . . .	555306	555305	553948	555996	553940	553940	553948	553940
(14) Spring, light unit fixing . . . . .	—	—	—	—	—	—	—	—
(15) §Bulb holder . . . . .	54520187	54520187	562303	554602	554602	554602	562303	554602
(16) § Sleeve, terminal . . . . .	—	—	555910	555910	555910	555910	555910	555910
(17) § Interior, pilot bulb holder . . . . .	—	—	—	—	—	—	—	—
(18) §Backshell . . . . .	—	—	‡552943	—	—	—	‡552943	—
(19) Clip and screw, adaptor . . . . .	—	—	562306	—	—	—	562306	—
(20) §Bulb, main . . . . .	355	370	—	414	370	350	—	370
(21) §Buffer, rubber . . . . .	—	—	—	—	—	—	—	—
(22) Conversion adaptor . . . . .	—	—	—	—	—	—	—	—
(23) §Gasket, rubber . . . . .	554279	554279	555415	554280	554279	554279	554279	554279
(24) Screw, with washer . . . . .	554288	554288	554288	554288	554288	554288	554288	554288
(25) Spring, trimmer . . . . .	552813	552813	552813	552813	552813	552813	552813	552813
(26) Motif . . . . .	—	—	—	—	—	—	—	—
(27) Screw, body fixing . . . . .	—	—	—	—	—	—	—	—
(28) Sleeve, sealing . . . . .	554626	554626	554626	554626	554626	554626	554626	554626
(29) §Plate, adaptor . . . . .	—	—	—	—	555541	555541	555541	555541
(30) §Gasket, adaptor plate seating . . . . .	—	—	—	—	555547	555547	555547	555547
(31) Grommet, cable entry . . . . .	—	—	—	—	—	—	—	—

For illustrations, see pages G25–G29

Note. For replacement lamp spare parts, see appropriate column under part number  
 † Supplied complete with Adaptor 562303 § Recommended spares for stock

† When ordering, quote part number shown in brackets  
 C.P.R. . . Chromium plated rim

# HEADLAMPS, Flush Fitting

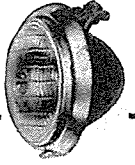

## DETAILED SPARE PARTS

51797B/E F700 C.P.R.	51808A PF700 C.P.R.	51810B PF700 C.P.R.	51811A PF700 C.P.R.	51812A PF700EF C.P.R.	51816D/H F700 C.P.R.	†51844A/D F700 C.P.R. (51899)	51878A F700 C.P.R.	51879A/B F700 C.P.R.	51880A/B F700 C.P.R.	51882A/B F700 C.P.R.	
555747	553978	553978	553978	553978	555326	555475	554982	554982	554982	554439	(1)
198898	552796	552796	552796	552796	101751	198897	554983	554983	554983	198898	(2)
161385	—	—	—	—	161385	161385	161385	161385	161385	161385	(3)
—	553980	553980	553980	553980	—	—	—	—	—	—	(4)
—	116003	116003	116003	116003	—	—	—	—	—	—	(5)
555704	553953	553953	553953	553953	554240	—	—	—	—	555704	(6)
187117	—	—	—	—	—	187117	—	—	—	187117	(7)
552906	553954	553954	553954	553954	555333	555477	552906	552906	552906	552906	(8)
554872	553971	553971	553971	553971	555351	554872	554872	554872	554872	554872	(9)
186137	186137	186137	186137	186137	186137	186137	186137	186137	186137	186137	(10)
554871	553972	553972	553972	553972	554871	554871	554871	554871	554871	554871	(11)
—	—	—	—	—	—	—	—	—	—	—	(12)
—	555752	555753	554917	555356	554665	555447	555991	555306	555305	555991	(13)
—	—	—	—	—	—	—	—	—	—	—	(14)
553724	554602	554602	554602	562303	554602	554602	54520187	54520187	54520187	54520187	(15)
—	555910	555910	555910	555910	555910	555910	—	—	—	—	(16)
—	—	—	—	—	—	—	—	—	—	—	(17)
—	—	—	—	‡552943	—	—	—	—	—	—	(18)
—	—	—	—	‡562306	—	—	—	—	—	—	(19)
—	354	355	370	—	370	355	354	355	370	354	(20)
—	—	—	—	—	—	—	—	—	—	—	(21)
555458	553955	553955	553955	553955	554279	554279	554279	554279	554279	554279	(22)
—	—	—	—	—	555332	—	—	—	—	—	(23)
554288	*552708	*552708	*552708	*552708	555344	554288	554288	554288	554288	554288	(24)
552813	553872	553872	553872	553872	553872	552813	552813	552813	552813	552813	(25)
—	—	—	—	—	—	—	—	—	—	—	(26)
—	117020	117020	117020	117020	‡555328	—	—	—	—	—	(27)
554626	554626	554626	554626	554626	554626	554626	554626	554626	554626	554626	(28)
—	—	—	—	—	—	555541	—	—	—	—	(29)
—	—	—	—	—	—	555547	—	—	—	—	(30)
—	—	—	—	—	199002	—	—	—	—	—	(31)

51898A/D F700 C.P.R.	51899A/D F700 C.P.R.	51901A/E F700 C.P.R.	51919B PF700 C.P.R.	51920B PF700 C.P.R.	51921B PF700 C.P.R.	51922B PF700 C.P.R.	51923B PF700 C.P.R.	51928A F700	51928B/D F700	51928E F700	
555475	555475	555770	556027	556027	556027	556027	556027	—	—	—	(1)
198897	198897	198913	552796	552796	552796	552796	552796	—	—	—	(2)
161385	161385	161385	—	—	—	—	—	—	—	—	(3)
—	—	—	116003	116003	116003	116003	116003	—	—	—	(4)
—	—	—	553953	553953	553953	553953	553953	—	—	—	(5)
187117	187117	187117	—	—	—	—	—	—	—	—	(6)
555477	555477	555477	554459	554459	554459	554459	554459	552906	552906	552906	(7)
554872	554872	554872	554906	554906	554906	554906	554906	554179	554179	554179	(8)
186137	186137	186137	186137	186137	186137	186137	186137	186143	186143	198949	(9)
554871	554871	554871	554907	554907	554907	554907	554907	554175	554175	554175	(10)
—	—	—	—	—	—	—	—	—	—	—	(11)
554665	555447	553921	555752	555754	555753	554917	555356	—	—	—	(12)
—	—	—	—	—	—	—	—	—	—	—	(13)
554602	553724	554602	554602	554855	554602	554602	562303	§554180	§554180	§554180	(14)
555910	—	555910	555910	—	555910	555910	555910	861216	864944	864944	(15)
—	—	—	—	—	—	—	—	—	—	—	(16)
—	—	—	—	—	—	—	—	—	—	—	(17)
—	—	—	—	—	—	—	—	—	—	—	(18)
—	—	—	—	—	—	—	—	—	—	—	(19)
—	—	—	—	—	—	—	—	—	—	—	(20)
370	355	414	354	404	355	370	—	—	—	—	(21)
—	—	—	—	—	—	—	—	—	—	—	(22)
—	554691	—	—	—	—	—	—	—	—	—	(23)
554279	554279	554279	553955	553955	553955	553955	553955	554178	554178	554178	(24)
554288	554288	554288	*552708	*552708	*552708	*552708	*552708	554182	554182	554182	(25)
552813	552813	552813	553872	553872	553872	553872	553872	**554202	**554202	**554202	(26)
—	—	—	—	—	—	—	—	—	—	—	(27)
—	—	—	117020	117020	117020	117020	117020	—	—	—	(28)
554626	554626	554626	554626	554626	554626	554626	554626	—	—	—	(29)
555541	555541	555541	—	—	—	—	—	—	—	—	(30)
555547	555547	555787	—	—	—	—	—	—	—	—	(31)
—	—	—	—	—	—	—	—	—	199003	199003	(32)

For illustrations, see pages G25–G29

\* See Supersession Chart    † When ordering, quote part number shown in brackets    ‡ Supplied complete with Adaptor 562303    || Gasket, sealing    continued  
 ¶ Screw, special, dip adjusting    § Spring, retaining, unit rim to body    \*\* Spring, retainer    C.P.R. .. Chromium plated rim

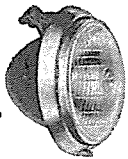

# HEADLAMPS, Flush Fitting

## DETAILED SPARE PARTS

Part No. . . . .	†51933A/D	51935A/D	51936A/B	51937A/D	51938A/D	51939A/D	51941A/E	51942A/B
Model . . . . .	F700	F700	F700EF	F700	F700	F700	F700	F700
Finish . . . . .	C.P.R.	C.P.R.	C.P.R.	C.P.R.	C.P.R.	C.P.R.	C.P.R.	C.P.R.
Replaced by (see footnote) . . . . .	(51939)	—	—	—	—	—	—	—
(1) §Rim or door . . . . .	555770	555770	555770	555770	555770	555770	555457	555747
(2) § Screw, rim fixing . . . . .	198913	198913	198913	198913	198913	198913	198898	198898
(3) Washer, screw retaining . . . . .	161385	161385	161385	161385	161385	161385	161385	161385
(4) Motif, top front . . . . .	—	—	—	—	—	—	—	—
(5) Bracket, rim fixing . . . . .	—	—	—	—	—	—	555704	555704
(6) §Nut, rim fixing screw . . . . .	187117	187117	187117	187117	187117	187117	187117	187117
(7) §Excluder, dust . . . . .	555477	555477	555477	555477	555477	555477	552906	552906
(8) §Plate, light unit retaining . . . . .	554872	554872	554872	554872	554872	554872	554872	554872
(9) Screw, unit rim . . . . .	186137	186137	186137	186137	186137	186137	186137	186137
(10) Rim, unit seating . . . . .	554871	554871	554871	554871	554871	554871	554871	554871
(11) Piece, packing . . . . .	—	—	—	—	—	—	—	—
(12) §Light unit . . . . .	555447	553940	553948	553940	554665	555447	553940	553940
(13) Spring, light unit fixing . . . . .	—	—	—	—	—	—	—	—
(14) §Bulb holder or adaptor . . . . .	554602	554602	562303	554602	554602	553724	554602	554602
(15) § Sleeve, terminal . . . . .	555910	555910	555910	555910	555910	—	555910	555910
(16) §Backshell . . . . .	—	—	§552943	—	—	—	—	—
(17) Clip and screw, adaptor . . . . .	—	—	562306	—	—	—	—	—
(18) §Bulb, main . . . . .	355	350	—	370	370	355	370	370
(19) Conversion adaptor . . . . .	—	—	—	—	—	554691	—	—
(20) §Gasket, rubber . . . . .	554279	554279	554279	554279	554279	554279	555458	555458
(21) Screw, with washer . . . . .	554288	554288	554288	554288	554288	554288	554288	554288
(22) Spring, trimmer . . . . .	552813	552813	552813	552813	552813	552813	552813	552813
(23) Motif . . . . .	—	—	—	—	—	—	—	—
(24) Screw, body fixing . . . . .	—	—	—	—	—	—	—	—
(25) Pin, split . . . . .	—	—	—	—	—	—	—	—
(26) Nut, barrel . . . . .	—	—	—	—	—	—	—	—
(27) Sleeve, sealing . . . . .	554626	554626	554626	554626	554626	554626	554626	554626
(28) §Plate, adaptor . . . . .	555541	555541	555541	555541	555541	555541	—	—
(29) §Gasket, adaptor plate seating . . . . .	555787	555787	555787	555787	555787	555787	—	—
(30) Grommet, cable entry . . . . .	—	—	—	—	—	—	—	—

Part No. . . . .	51967A/E	51968A/E	51969A/E	51970A/D	51971B/H	51972A/D	51982A	†51983A/E
Model . . . . .	F700	F700	F700	F700EF	F700	F700	F700	P700
Finish . . . . .	C.P.R.	C.P.R.	C.P.R.	C.P.R.	C.P.R.	C.P.R.	C.P.R.	C.P.R.
Replaced by (see footnote) . . . . .	—	—	—	—	—	—	—	(51538)
(1) §Rim or door . . . . .	556080	556080	556080	556080	556275	554439	554225	554439
(2) § Screw, rim fixing . . . . .	198937	198937	198937	198937	198898	198898	554222	198898
(3) Washer, screw retaining . . . . .	161385	161385	161385	161385	161385	161385	—	161385
(4) Motif, top front . . . . .	‡556221	‡556221	‡556221	‡556221	—	—	—	—
(5) Bracket, rim fixing . . . . .	556222	556222	556222	556222	555704	555704	—	555704
(6) §Nut, rim fixing screw . . . . .	187113	187113	187113	187113	187117	187117	—	187117
(7) §Excluder, dust . . . . .	555955	555955	555955	555955	552906	552906	552906	552906
(8) §Plate, light unit retaining . . . . .	554872	554872	554872	554872	554872	554872	554179	554872
(9) Screw, unit rim . . . . .	186137	186137	186137	186137	186137	186137	186134	186137
(10) Rim, unit seating . . . . .	554871	554871	554871	554871	554871	554871	554175	554871
(11) Piece, packing . . . . .	—	—	—	553537	—	—	—	—
(12) §Light unit . . . . .	553921	555447	553940	553948	553921	555296	553940	554308
(13) Spring, light unit fixing . . . . .	—	—	—	—	—	—	‡554180	—
(14) §Bulb holder or adaptor . . . . .	554602	554602	554602	562303	554602	553724	861216	554602
(15) § Sleeve, terminal . . . . .	555910	555910	555910	555910	555910	—	—	555910
(16) § Interior, pilot bulb holder . . . . .	—	—	—	—	—	—	—	—
(17) §Backshell . . . . .	—	—	—	§552943	—	—	—	—
(18) Clip and screw, adaptor . . . . .	—	—	—	562306	—	—	—	—
(19) §Bulb, main . . . . .	354	355	370	—	414	355	370	414
(20) Conversion adaptor . . . . .	—	—	—	—	—	554691	554691	—
(21) §Gasket, rubber . . . . .	556079	556079	556079	556079	555458	554279	554178	554279
(22) Screw, with washer . . . . .	554288	554288	554288	554288	554288	554288	554182	554288
(23) Spring, trimmer . . . . .	552813	552813	552813	552813	552813	552813	‡554202	552813
(24) Screw, body fixing . . . . .	—	—	—	—	—	—	—	—
(25) Pin, split . . . . .	—	—	—	—	—	—	186761	—
(26) Sleeve, sealing . . . . .	554626	554626	554626	554626	554626	554626	—	554626
(27) §Plate, adaptor . . . . .	—	—	—	—	—	—	—	—
(28) §Excluder, dust, bulb holder . . . . .	—	—	—	—	—	—	—	—
(29) Washer, cable grip . . . . .	—	—	—	—	—	—	—	—
(30) Washer, cable grip . . . . .	—	—	—	—	—	—	—	—
(31) Grommet, cable entry . . . . .	—	—	—	—	—	—	—	—
(32) §Gasket, adaptor plate seating . . . . .	—	—	—	—	—	—	—	—

For illustrations, see pages G25–G29

Note. For replacement lamp spare parts, see appropriate column under part number † When ordering, quote part number shown in brackets ‡ Plate, rim retaining  
 § Recommended spares for stock || Spring, unit rim to body retaining ¶ Spring, retainer § Supplied complete with Adaptor 562303 C.P.R. Chromium plated rim

# HEADLAMPS, Flush Fitting

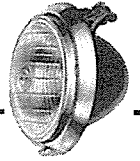

## DETAILED SPARE PARTS

51946B/D F700 C.P.R.	51947A/B F700 C.P.R.	51948A F700EF C.P.R.	51949A F700 C.P.R.	51953A/D F700 C.P.R.	51956A/F F700 C.P.R.	51957A/E F700 C.P.R.	51958B/D F700EF C.P.R.	51959A/E F700 C.P.R.	51960A/D F700 C.P.R.	†51966A/E F700 C.P.R. (51957)	
555974	555974	555974	555974	554440	556234	556234	556234	556234	—	556234	(1)
113061	113061	113061	113061	198898	198898	198898	198898	198898	—	198898	(2)
161385	161385	161385	161385	161385	161385	161385	161385	161385	—	161385	(3)
—	—	—	—	—	—	—	—	—	—	—	(4)
—	—	—	—	555704	555704	555704	555704	555704	555704	555704	(5)
—	—	—	—	187117	187117	187117	187117	187117	187117	187117	(6)
552906	552906	552906	552906	552906	552906	552906	552906	552906	—	552906	(7)
554872	554872	554872	554872	554872	554872	554872	554872	554872	554872	554872	(8)
186137	186137	186137	186137	186137	186137	186137	186137	186137	186137	186137	(9)
554871	554871	554871	554871	554871	554871	554871	554871	554871	554871	554871	(10)
—	—	—	—	—	—	—	—	—	—	—	(11)
553921	553940	553948	—	556229	553921	555447	553948	553940	554665	555447	(12)
—	—	—	—	—	—	—	—	—	—	—	(13)
554602	554602	562303	553724	554602	554602	553738	562303	554602	554602	554602	(14)
555910	555910	555910	—	555910	555910	555910	555910	555910	555910	555910	(15)
—	—	§552943	—	—	—	—	§552943	—	—	—	(16)
—	—	562306	—	—	—	—	562306	—	—	—	(17)
414	370	—	—	355	414	355	—	370	370	355	(18)
—	—	—	—	—	—	554691	—	—	—	—	(19)
556247	556247	556247	556247	554280	554280	554280	554280	554280	554279	554280	(20)
554288	554288	554288	554288	554288	554288	554288	554288	554288	554288	554288	(21)
552813	552813	552813	552813	552813	552813	552813	552813	552813	552813	552813	(22)
—	—	—	—	—	—	—	—	—	—	—	(23)
—	—	—	—	—	—	—	—	—	—	—	(24)
—	—	—	—	—	—	—	—	—	—	—	(25)
—	—	—	—	—	—	—	—	—	—	—	(26)
554626	554626	554626	554626	554626	554626	554626	554626	554626	554626	554626	(27)
—	—	—	—	—	—	—	—	—	—	—	(28)
—	—	—	—	—	—	—	—	—	—	—	(29)
—	—	—	—	—	—	—	—	—	—	—	(30)

†51984A/B F700 C.P.R. (51467)	51987A/B F700 C.P.R.	51988A/D F700 C.P.R.	51989B/F F700 C.P.R.	51990B/F F700EF C.P.R.	51991B/E F700 C.P.R.	51999A F700 C.P.R.	58006A/E F700 C.P.R.	58007A/D F700 C.P.R.	58008A/D F700 C.P.R.	58009A/B F700EF C.P.R.	
554439	554440	556291	556275	556275	556275	554225	556353	556353	556353	556353	(1)
198898	198898	552816	198898	198898	198898	554222	198937	198937	198937	198937	(2)
161385	161385	161385	161385	161385	161385	—	161385	161385	161385	161385	(3)
—	—	—	—	—	—	—	—	—	—	—	(4)
555704	555704	—	555704	555704	555704	—	555704	555704	555704	555704	(5)
187117	187117	—	187117	187117	187117	—	187117	187117	187117	187117	(6)
552906	552906	552906	552906	552906	552906	552906	552906	552906	552906	552906	(7)
554872	554872	554872	554872	554872	554872	554179	554872	554872	554872	554872	(8)
186137	186137	186137	186137	186137	186137	186134	186137	186137	186137	186137	(9)
554871	554871	554871	554871	554871	554871	554175	554871	554871	554871	554871	(10)
—	—	—	—	553537	—	556365	—	—	—	—	(11)
—	555447	556288	553940	553948	—	553948	553921	555447	553940	553948	(12)
—	—	—	—	—	—	‡554180	—	—	—	—	(13)
553738	553724	554603	554602	562303	553724	861216	554602	554602	554602	562303	(14)
555910	—	555910	555910	555910	—	—	555910	555910	555910	555910	(15)
—	—	—	—	—	—	—	—	—	—	—	(16)
—	—	—	—	§552943	—	556064	—	—	—	§552943	(17)
—	—	—	—	562306	—	562306	—	—	—	562306	(18)
—	355	¶989 370	370	—	—	—	414	355	370	—	(19)
—	554691	—	—	—	—	—	—	—	—	—	(20)
554279	555415	556289	555458	555458	555458	554178	556345	556345	556345	556345	(21)
554288	554288	554288	554288	554288	554288	554182	554288	554288	554288	554288	(22)
552813	552813	552813	552813	552813	552813	¶554202	552813	552813	552813	552813	(23)
—	—	—	—	—	—	—	—	—	—	—	(24)
—	—	—	—	—	—	186761	—	—	—	—	(25)
554626	554626	554626	554626	554626	554626	—	554626	554626	554626	554626	(26)
—	—	556285	—	—	—	—	—	—	—	—	(27)
—	—	556047	—	—	—	—	—	—	—	—	(28)
—	—	516285	—	—	—	—	—	—	—	—	(29)
—	—	553568	—	—	—	—	—	—	—	—	(30)
—	—	—	—	—	—	—	—	—	—	—	(31)
—	—	—	—	—	—	—	—	—	—	—	(32)

For illustrations, see pages G25–G29

† When ordering, quote part number shown in brackets  
§ Supplied complete with Adaptor 562303

‡ Spring, unit rim to body retaining  
Chromium plated rim

¶ Pilot

§ Spring, retainer

continued

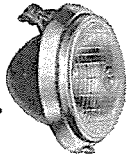

# HEADLAMPS, Flush Fitting

## DETAILED SPARE PARTS

Part No. . . . .	58010A/D F700 C.P.R.	58011A/B F700 C.P.R.	58022A/B F700EF C.P.R.	58023A/B F700EF C.P.R.	†58024A/D F700 (58041)	†58025A/D F700 (58042)	†58026A/D F700 (58043)	†58027A/D F700 (58044)
(1) §Rim or door . . . . .	556353	556353	555326	555326	556431	556431	556431	556431
(2) § Screw, rim fixing . . . . .	198937	198937	144471	144471	198913	198913	198913	198913
(3) Washer, screw retaining . . . . .	161385	161385	161385	161385	161385	161385	161385	161385
(4) Bracket, rim fixing . . . . .	555704	555704	554240	554240	—	—	—	—
(5) §Nut, rim fixing screw . . . . .	187117	187117	—	—	187117	187117	187117	187117
(6) §Excluder, dust . . . . .	552906	552906	555333	555333	555477	555477	555477	555477
(7) §Plate, light unit retaining . . . . .	554872	554872	555351	555351	554872	554872	554872	554872
(8) Screw, unit rim . . . . .	186137	186137	186137	186137	186137	186137	186137	186137
(9) Rim, unit seating . . . . .	554871	554871	554871	554871	554871	554871	554871	554871
(10) Piece, packing . . . . .	—	—	—	553537	—	—	—	—
(11) §Light unit . . . . .	555447	—	556379	556380	553921	555447	553940	553940
(12) Spring, light unit fixing . . . . .	—	—	—	—	—	—	—	—
(13) Screw, plate fixing . . . . .	—	—	—	—	—	—	—	—
(14) §Bulb holder or adaptor . . . . .	553724	553724	555725	555725	554602	554602	554602	554602
(15) § Sleeve, terminal . . . . .	—	—	555910	555910	555910	555910	555910	555910
(16) § Interior, pilot bulb holder . . . . .	—	—	—	—	—	—	—	—
(17) §Backshell . . . . .	—	—	—	—	—	—	—	—
(18) Clip and screw, adaptor . . . . .	—	—	—	—	—	—	—	—
(19) §Bulb, main . . . . .	355	—	—	—	354	355	370	350
(20) Conversion adaptor . . . . .	554691	—	—	—	—	—	—	—
(21) §Gasket, rubber . . . . .	556345	556345	554279	554279	554279	554279	554279	554279
(22) Screw, with washer . . . . .	554288	554288	‡555332	‡555332	554288	554288	554288	554288
(23) Spring, trimmer . . . . .	552813	552813	553872	553872	552813	552813	552813	552813
(24) Screw, body fixing . . . . .	—	—	‡555328	‡555328	—	—	—	—
(25) Washer, spring . . . . .	—	—	—	—	—	—	—	—
(26) Screw, body fixing . . . . .	—	—	—	—	—	—	—	—
(27) Sleeve, sealing . . . . .	554626	554626	554626	554626	554626	554626	554626	554626
(28) §Plate, adaptor . . . . .	—	—	—	—	555541	555541	555541	555541
(29) §Gasket, adaptor plate seating . . . . .	—	—	—	—	555787	555787	555787	555787
(30) Grommet, cable entry . . . . .	—	—	199002	199002	—	—	—	—

Part No. . . . .	58045A/B F700EF	58046A/D F700	58047A/D F700	58048A/E F700 C.P.R.	58049A/D F700 C.P.R.	58050A/D F700 C.P.R.	58051A/B F700EF C.P.R.	58056A/B F700 C.P.R.
(1) §Rim or door . . . . .	556431	556431	556431	556390	556390	556390	556390	556432
(2) § Screw, rim fixing . . . . .	198913	198913	198913	198913	198913	198913	198913	198913
(3) Washer, screw retaining . . . . .	161385	161385	161385	161385	161385	161385	161385	161385
(4) Bracket, rim fixing . . . . .	—	—	—	556362	556362	556362	556362	556362
(5) §Nut, rim fixing screw . . . . .	187117	187117	187117	187113	187113	187113	187113	187113
(6) §Excluder, dust . . . . .	555477	555477	555477	556388	556388	556388	556388	556388
(7) §Plate, light unit retaining . . . . .	554872	554872	554872	554872	554872	554872	554872	554872
(8) Screw, unit rim . . . . .	186137	186137	186137	186137	186137	186137	186137	186137
(9) Rim, unit seating . . . . .	554871	554871	554871	554871	554871	554871	554871	554871
(10) Piece, packing . . . . .	—	—	—	—	—	—	—	—
(11) §Light unit . . . . .	553948	554665	555447	553921	555447	553940	553948	553921
(12) §Bulb holder or adaptor . . . . .	562303	554602	553724	554602	554602	554602	562303	554602
(13) § Sleeve, terminal . . . . .	555910	555910	—	555910	555910	555910	555910	555910
(14) § Interior, pilot bulb holder . . . . .	—	—	—	—	—	—	—	—
(15) §Backshell . . . . .	‡552943	—	—	—	—	—	‡552943	—
(16) Clip and screw, adaptor . . . . .	562306	—	—	—	—	—	562306	—
(17) §Bulb, main . . . . .	—	370	355	414	355	370	—	354
(18) §Buffer, rubber . . . . .	—	—	—	—	—	—	—	—
(19) Conversion adaptor . . . . .	—	—	554691	—	—	—	—	—
(20) §Gasket, rubber . . . . .	554279	554279	554279	556446	556446	556446	556446	556446
(21) Screw, with washer . . . . .	554288	554288	554288	554288	554288	554288	554288	554288
(22) Spring, trimmer . . . . .	552813	552813	552813	552813	552813	552813	552813	552813
(23) Motif . . . . .	—	—	—	—	—	—	—	—
(24) Screw, body fixing . . . . .	—	—	—	—	—	—	—	—
(25) Sleeve, sealing . . . . .	554626	554626	554626	554626	554626	554626	554626	554626
(26) §Plate, adaptor . . . . .	555541	555541	555541	—	—	—	—	—
(27) §Gasket, adaptor plate seating . . . . .	555787	555787	555787	—	—	—	—	—
(28) Plate, rim fixing . . . . .	—	—	—	—	—	—	—	—
(29) Nut, plate fixing screw . . . . .	—	—	—	—	—	—	—	—
(30) Screw, adaptor plate fixing . . . . .	—	—	—	—	—	—	—	—
(31) Bracket, rim seating . . . . .	—	—	—	—	—	—	—	—

For illustrations, see pages G25-G29

Note. For replacement lamp spare parts, see appropriate column under part number † When ordering, quote part number shown in brackets ‡ Gasket, sealing  
§ Recommended spares for stock || Screw, special, dip adjusting ¶ Supplied complete with Adaptor 562303 C.P.R. . . Chromium plated rim

# HEADLAMPS, Flush Fitting

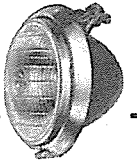

## DETAILED SPARE PARTS

†58028A/B F700EF (58045)	†58029A/D F700 (58046)	†58030A/D F700 (58047)	58034A/H F700 C.P.R. —	58035A/F F700 C.P.R. —	58036A/F F700 C.P.R. —	58038A/B F700 C.P.R. —	58041A/E F700 —	58042A/D F700 —	58043A/D F700 —	58044A/D F700 —	
556431	556431	556431	556429	556429	556429	554440	556431	556431	556431	556431	556431 (1)
198913	198913	198913	—	—	—	198898	198913	198913	198913	198913	198913 (2)
161385	161385	161385	—	—	—	161385	161385	161385	161385	161385	161385 (3)
—	—	—	—	—	—	555704	—	—	—	—	— (4)
187117	187117	187117	—	—	—	187117	187117	187117	187117	187117	187117 (5)
555477	555477	555477	—	—	—	552906	555477	555477	555477	555477	555477 (6)
554872	554872	554872	554872	554872	554872	554872	554872	554872	554872	554872	554872 (7)
186137	186137	186137	186137	186137	186137	186137	186137	186137	186137	186137	186137 (8)
554871	554871	554871	554871	554871	554871	554871	554871	554871	554871	554871	554871 (9)
—	—	—	—	—	—	—	—	—	—	—	— (10)
553948	554665	555447	553921	555447	553940	553948	553921	555447	553940	553940	553940 (11)
—	—	—	—	—	—	—	—	—	—	—	— (12)
—	—	—	—	—	—	—	—	—	—	—	— (13)
562303	554602	553724	554602	554602	554602	507701	554602	554602	554602	554602	554602 (14)
555910	555910	555910	555910	555910	555910	555910	555910	555910	555910	555910	555910 (15)
—	—	—	—	—	—	—	—	—	—	—	— (16)
552943	—	—	—	—	—	—	—	—	—	—	— (17)
562306	—	—	—	—	—	556434	—	—	—	—	— (18)
—	—	—	—	—	—	562306	—	—	—	—	— (19)
—	370	355	414	355	370	—	414	355	370	350	350 (20)
—	—	554691	—	—	—	—	—	—	—	—	— (21)
554279	554279	554279	554280	554280	554280	554280	554279	554279	554279	554279	554279 (22)
554288	554288	554288	554288	554288	554288	554288	554288	554288	554288	554288	554288 (23)
552813	552813	552813	552813	552813	552813	552813	552813	552813	552813	552813	552813 (24)
—	—	—	—	—	—	—	—	—	—	—	— (25)
—	—	—	—	—	—	—	—	—	—	—	— (26)
554626	554626	554626	554626	554626	554626	554626	554626	554626	554626	554626	554626 (27)
555541	555541	555541	—	—	—	—	555541	555541	555541	555541	555541 (28)
555787	555787	555787	—	—	—	—	555787	555787	555787	555787	555787 (29)
—	—	—	—	—	—	—	—	—	—	—	— (30)

58057A/B F700 C.P.R. —	58058A/B F700 C.P.R. —	58059A F700EF C.P.R. —	†58070A/D F700 C.P.R. (51533)	58078A/D F700 C.P.R. —	58083A/E F700 C.P.R. —	58084A/D F700 C.P.R. —	58085A/B F700EF C.P.R. —	58086A/D F700 C.P.R. —	58087A F700 C.P.R. —	†58096A/L F700 (58433)	
556432	556432	556432	554439	554439	554440	554440	554440	554440	556353	556498	556498 (1)
198913	198913	198913	198898	198898	198898	198898	198898	198898	198937	198898	198898 (2)
161385	161385	161385	161385	161385	161385	161385	161385	161385	161385	161385	161385 (3)
556362	556362	556362	555704	555704	555704	555704	555704	555704	555704	556482	556482 (4)
187113	187113	187113	187117	187117	187117	187117	187117	187117	187117	187117	187117 (5)
556388	556388	556388	552906	552906	552906	552906	552906	552906	552906	556544	556544 (6)
554872	554872	554872	554872	554872	554872	554872	554872	554872	554872	554872	554872 (7)
186137	186137	186137	186137	186137	186137	186137	186137	186137	186137	186137	186137 (8)
554871	554871	554871	554871	554871	554871	554871	554871	554871	554871	554871	554871 (9)
—	—	553537	—	—	—	—	—	—	—	—	— (10)
555447	553940	553948	555447	553921	553921	553940	553948	555447	554999	553921	553921 (11)
554602	554602	562303	553738	553738	554602	554602	562303	554602	54520187	554602	554602 (12)
555910	555910	555910	555910	555910	555910	555910	555910	555910	‡534488	555910	555910 (13)
—	—	—	—	—	—	—	—	—	—	—	— (14)
—	—	552943	—	—	—	—	552943	—	554909	—	— (15)
—	—	562306	—	—	—	—	562306	—	—	—	— (16)
355	370	—	355	354	414	370	—	355	404	414	414 (17)
—	—	—	—	—	—	—	—	—	—	—	— (18)
—	—	—	554691	554691	—	—	—	—	—	—	— (19)
556446	556446	556446	554279	554279	554280	554280	554280	554280	556345	554279	554279 (20)
554288	554288	554288	554288	554288	554288	554288	554288	554288	554288	554288	554288 (21)
552813	552813	552813	552813	552813	552813	552813	552813	552813	552813	552813	552813 (22)
—	—	—	—	—	—	—	—	—	—	—	— (23)
—	—	—	—	—	—	—	—	—	—	—	— (24)
554626	554626	554626	554626	554626	554626	554626	554626	554626	554626	554626	554626 (25)
—	—	—	—	—	—	—	—	—	—	—	— (26)
—	—	—	—	—	—	—	—	—	—	556492	556492 (27)
—	—	—	—	—	—	—	—	—	—	556500	556500 (28)
—	—	—	—	—	—	—	—	—	—	187114	187114 (29)
—	—	—	—	—	—	—	—	—	—	198923	198923 (30)
—	—	—	—	—	—	—	—	—	—	556499	556499 (31)

For illustrations, see pages G26–G29

† When ordering, quote part number shown in brackets  
C.P.R. ... Chromium plated rim

‡ Spring, bulb retaining

|| Supplied complete with Adaptor 562303

continued

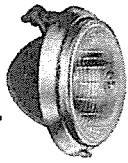

# HEADLAMPS, Flush Fitting

## DETAILED SPARE PARTS

Part No. . . . .	†58097A/K	†58098A/K	58099A	58099B/F	58100A	58100B/E	58101A	58101B/E
Model . . . . .	F700	F700	F700	F700	F700	F700	F700	F700
Finish . . . . .	—	—	C.P.R.	C.P.R.	C.P.R.	C.P.R.	C.P.R.	C.P.R.
Replaced by (see footnote)	(58434)	(58435)	—	—	—	—	—	—
(1) §Rim or door . . . . .	556498	556498	555747	555747	555747	555747	555747	555747
(2) §Screw, rim fixing . . . . .	198898	198898	198898	198898	198898	198898	198898	198898
(3) Washer, screw retaining . . . . .	161385	161385	161385	161385	161385	161385	161385	161385
(4) Motif, top front or embellisher . . . . .	—	—	—	—	—	—	—	—
(5) Screw, embellisher, bracket and motif fixing . . . . .	—	—	—	—	—	—	—	—
(6) Bracket, rim fixing . . . . .	556482	556482	555704	555704	555704	555704	555704	555704
(7) §Nut, rim fixing screw . . . . .	187117	187117	187117	187117	187117	187117	187117	187117
(8) §Excluder, dust . . . . .	556544	556544	552906	552906	552906	552906	552906	552906
(9) §Plate, light unit retaining . . . . .	554872	554872	554872	554872	554872	554872	554872	554872
(10) Screw, unit rim . . . . .	186137	186137	186137	186137	186137	186137	186137	186137
(11) Rim, unit seating . . . . .	554871	554871	554871	554871	554871	554871	554871	554871
(12) Piece, packing . . . . .	—	—	—	—	—	—	—	—
(13) §Light unit . . . . .	555447	553940	553921	553921	555447	555447	553921	553921
(14) Spring, light unit fixing . . . . .	—	—	—	—	—	—	—	—
(15) §Bulb holder or adaptor . . . . .	554602	554602	554602	554602	554602	554602	553724	553738
(16) § Sleeve, terminal . . . . .	555910	555910	555910	555910	555910	555910	—	555910
(17) § Interior, pilot bulb holder . . . . .	—	—	—	—	—	—	—	—
(18) §Backshell . . . . .	—	—	—	—	—	—	—	—
(19) Clip and screw, adaptor . . . . .	—	—	—	—	—	—	—	—
(20) §Bulb, main . . . . .	355	370	354	414	355	355	354	354
(21) Conversion adaptor . . . . .	—	—	—	—	—	—	554691	554691
(22) §Gasket, rubber . . . . .	554279	554279	555458	556521	555458	556521	555458	556521
(23) Screw, with washer . . . . .	554288	554288	554288	554288	554288	554288	554288	554288
(24) Spring, trimmer . . . . .	552813	552813	552813	552813	552813	552813	552813	552813
(25) Screw, body fixing . . . . .	—	—	—	—	—	—	—	—
(26) Sleeve, sealing . . . . .	554626	554626	554626	554626	554626	554626	554626	554626
(27) §Plate, adaptor . . . . .	—	—	—	—	—	—	—	—
(28) Nut, plate fixing screw . . . . .	187114	187114	—	—	—	—	—	—
(29) §Gasket, adaptor plate seating . . . . .	556492	556492	—	—	—	—	—	—
(30) Washer, cable grip . . . . .	—	—	—	—	—	—	—	—
(31) Plate, rim fixing . . . . .	556500	556500	—	—	—	—	—	—
(32) Screw, adaptor plate fixing . . . . .	198923	198923	—	—	—	—	—	—
(33) Bracket, rim fixing . . . . .	556499	556499	—	—	—	—	—	—

Part No. . . . .	58139A/D	58140A/B	58141A/B	58142A	58142B/D	58143A/D	58144A/D	58145A/B
Model . . . . .	F700	F700EF	F700	F700	F700	F700	F700	F700
Finish . . . . .	—	—	—	C.P.R.	C.P.R.	C.P.R.	C.P.R.	C.P.R.
Replaced by (see footnote)	—	—	—	—	—	—	—	—
(1) §Rim or door . . . . .	556511	556511	556511	556420	556420	555747	555747	555747
(2) §Screw, rim fixing . . . . .	198898	198898	198898	—	—	198898	198898	198898
(3) Washer, screw retaining . . . . .	161385	161385	161385	—	—	161385	161385	161385
(4) Motif, top front or embellisher . . . . .	556503	556503	556503	—	—	—	—	—
(5) Screw, embellisher, bracket and motif fixing . . . . .	198948	198948	198948	—	—	—	—	—
(6) Bracket, rim fixing . . . . .	555704	555704	555704	—	—	555704	555704	555704
(7) §Nut, rim fixing screw . . . . .	187117	187117	187117	—	—	187117	187117	187117
(8) §Excluder, dust . . . . .	552906	552906	552906	552906	552906	552906	552906	552906
(9) §Plate, light unit retaining . . . . .	554872	554872	554872	554872	554872	554872	554872	554872
(10) Screw, unit rim . . . . .	186137	186137	186137	186137	186137	186137	186137	186137
(11) Rim, unit seating . . . . .	554871	554871	554871	554871	554871	554871	554871	554871
(12) Piece, packing . . . . .	—	—	—	—	—	—	—	553537
(13) §Light unit . . . . .	553940	553948	—	556599	556599	554308	553940	553948
(14) Spring, fixing or retaining . . . . .	—	—	—	—	—	—	—	—
(15) Spring, bulb retaining . . . . .	—	—	—	—	556442	—	—	—
(16) §Bulb holder or adaptor . . . . .	554602	562303	553724	54520187	553724	554602	554602	562303
(17) § Sleeve, terminal . . . . .	555910	555910	—	—	—	555910	555910	555910
(18) §Backshell . . . . .	—	‡552943	—	554909	—	—	—	‡552943
(19) Clip and screw, adaptor . . . . .	—	562306	—	—	—	—	—	562306
(20) §Bulb, main . . . . .	370	—	—	404	416	354	370	—
(21) Conversion adaptor . . . . .	—	—	—	—	—	—	—	—
(22) §Gasket, rubber . . . . .	555458	555458	555458	556422	556422	556521	556521	556521
(23) Screw, with washer . . . . .	554288	554288	554288	554288	554288	554288	554288	554288
(24) Spring, trimmer . . . . .	552813	552813	552813	552813	552813	552813	552813	552813
(25) Screw, body fixing . . . . .	—	—	—	—	—	—	—	—
(26) Sleeve, sealing . . . . .	554626	554626	554626	554626	554626	554626	554626	554626
(27) §Plate, adaptor . . . . .	—	—	—	556491	556491	—	—	—
(28) §Gasket, adaptor plate seating . . . . .	—	—	—	—	—	—	—	—
(29) Screw, adaptor plate fixing . . . . .	—	—	—	—	—	—	—	—
(30) Nut, plate fixing screw . . . . .	—	—	—	—	—	—	—	—
(31) Bracket, rim locating . . . . .	—	—	—	—	—	—	—	—
(32) Grommet, cable entry . . . . .	—	—	—	—	—	—	—	—

For illustrations, see pages G25–G29

Note. For replacement lamp spare parts, see appropriate column under part number † When ordering, quote part number shown in brackets  
 ‡ Supplied complete with Adaptor 562303 § Recommended spares for stock C.P.R. . . Chromium plated rim





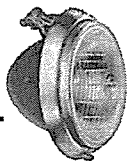

# HEADLAMPS, Flush Fitting

## DETAILED SPARE PARTS

Part No. . . . .		58188A	58188B	58189A	58190A	58190B/E	58218A/D	58219A/B	58220A/B
Model . . . . .		F700	F700	PF700	F700P	F700P	F700	F700	F700
Finish . . . . .		C.P.R.	C.P.R.	C.P.R.	C.P.R.	C.P.R.	C.P.R.	C.P.R.	C.P.R.
Replaced by (see footnote) . . . . .		—	—	—	—	—	—	—	—
(1) §Rim or door . . . . .		552913	552913	556517	554439	554439	54520122	54520122	54520122
(2) § Screw, rim fixing . . . . .		552816	552816	552796	198898	198898	54127511	54127511	54127511
(3) Washer, screw retaining . . . . .		—	—	—	161385	161385	161385	161385	161385
(4) Screw, bracket and motif fixing . . . . .		—	—	116003	—	—	—	—	—
(5) Bracket, rim fixing . . . . .		—	—	553953	555704	555704	—	—	—
(6) §Nut, rim fixing screw . . . . .		—	—	—	187117	187117	—	—	—
(7) §Excluder, dust . . . . .		552906	552906	553954	552906	552906	552906	552906	552906
(8) §Plate, light unit retaining . . . . .		554872	554872	553971	554872	554872	554872	554872	554872
(9) Screw, unit rim . . . . .		186137	186137	186137	186137	186137	186137	186137	186137
(10) Rim, unit seating . . . . .		554871	554871	553972	554871	554871	554871	554871	554871
(11) Piece, packing . . . . .		553537	553537	—	—	—	—	—	—
(12) §Light unit . . . . .		554308	554999	—	556597	54520132	553921	555447	553940
(13) Spring, light unit fixing . . . . .		—	—	—	—	—	—	—	—
(14) Spring, bulb retaining . . . . .		—	534488	—	—	—	—	—	—
(15) §Bulb holder or adaptor . . . . .		554602	54520187	553724	554603	554602	554602	554602	554602
(16) § Sleeve, terminal . . . . .		555910	555910	—	555910	555910	555910	555910	555910
(17) § Interior, pilot bulb holder . . . . .		—	554855	—	553780	553780	—	—	—
(18) §Backshell . . . . .		—	554909	—	—	554710	—	—	—
(19) Clip and screw, adaptor . . . . .		—	—	—	—	554354	—	—	—
(20) §Bulb, main . . . . .		354	404	—	355 **989	355 **222	414	355	370
(21) Conversion adaptor . . . . .		—	—	—	—	—	—	—	—
(22) §Gasket, rubber . . . . .		552915	552915	553955	554279	554279	556590	556590	556590
(23) Screw, with washer . . . . .		554288	554288	*552708	554288	554288	554288	554288	554288
(24) Spring, trimmer . . . . .		552813	552813	553872	552813	552813	552813	552813	552813
(25) Screw, motif fixing . . . . .		—	—	—	—	—	—	—	—
(26) Washer, spring . . . . .		—	—	—	—	—	—	—	—
(27) Screw, body fixing . . . . .		—	—	117020	—	—	—	—	—
(28) Sleeve, sealing . . . . .		554626	554626	554626	554626	554626	554626	554626	554626
(29) §Plate adaptor . . . . .		—	—	—	—	—	—	—	—
(30) §Gasket, adaptor plate seating . . . . .		—	—	—	—	—	—	—	—
(31) Grommet, cable entry . . . . .		—	—	—	—	—	—	—	—

Part No. . . . .		58251A/F	58252A/F	58253A/E	58254A/E	58255A/B	58260A/D	58261A	58262A
Model . . . . .		F700	F700	F700	F700EF	F700	F700	F700EF	F700
Finish . . . . .		C.P.R.	C.P.R.	C.P.R.	C.P.R.	C.P.R.	C.P.R.	C.P.R.	C.P.R.
Replaced by (see footnote) . . . . .		—	—	—	—	—	—	—	—
(1) §Rim or door . . . . .		54520158	54520158	54520158	54520158	54520158	54520073	54520073	54520073
(2) § Screw, rim fixing . . . . .		198913	198913	198913	198913	198913	—	—	—
(3) Washer, screw retaining . . . . .		161385	161385	161385	161385	161385	—	—	—
(4) Motif, top front . . . . .		—	—	—	—	—	—	—	—
(5) Bracket, rim fixing . . . . .		555940	555940	555940	555940	555940	—	—	—
(6) §Nut, rim fixing screw . . . . .		187117	187117	187117	187117	187117	—	—	—
(7) §Excluder, dust . . . . .		—	—	—	—	54520495	552906	552906	552906
(8) §Plate, light unit retaining . . . . .		554872	554872	554872	554872	554872	554872	554872	554872
(9) Screw, unit rim . . . . .		186137	186137	186137	186137	186137	186137	186137	186137
(10) Rim, unit seating . . . . .		554871	554871	554871	554871	554871	554871	554871	554871
(11) Piece, packing . . . . .		—	—	—	—	—	—	—	—
(12) §Light unit . . . . .		553921	555447	556452	556452	—	553921	553948	—
(13) Spring, light unit fixing . . . . .		—	—	—	—	—	—	—	—
(14) Screw, plate fixing . . . . .		—	—	—	—	—	—	—	—
(15) Spring, bulb retaining . . . . .		—	—	556442	556442	—	—	—	—
(16) §Bulb holder or adaptor . . . . .		554602	554602	553738	553738	553738	554602	562303	553724
(17) § Sleeve, terminal . . . . .		555910	555910	555910	555910	555910	555910	555910	—
(18) § Interior, pilot bulb holder . . . . .		—	—	—	—	—	—	—	—
(19) §Backshell . . . . .		—	—	—	—	—	—	†552943	—
(20) Clip and screw, adaptor . . . . .		—	—	—	—	—	—	562306	—
(21) §Bulb, main . . . . .		414	355	410	411	—	414	—	—
(22) §Buffer, rubber . . . . .		—	—	—	—	—	—	—	—
(23) Conversion adaptor . . . . .		—	—	—	—	—	—	—	—
(24) §Gasket, rubber . . . . .		54520723	54520723	54520723	54520723	54520723	554280	554280	54520131
(25) Screw, with washer . . . . .		554288	554288	554288	554288	554288	554288	554288	554288
(26) Spring, trimmer . . . . .		552813	552813	552813	552813	552813	552813	552813	552813
(27) Screw, motif fixing . . . . .		—	—	—	—	—	—	—	—
(28) Washer, spring . . . . .		—	—	—	—	—	—	—	—
(29) Motif . . . . .		—	—	—	—	—	—	—	—
(30) Screw, body fixing . . . . .		—	—	—	—	—	—	—	—
(31) Sleeve, sealing . . . . .		554626	554626	554626	554626	554626	554626	554626	554626

For illustrations, see pages G25-G29

Note. For replacement lamp spare parts, see appropriate column under part number \* See Supersession Chart § Recommended spares for stock †† Cable and adaptor  
 † Bulb holder, pilot § Ring, pilot bulb holder seating \*\* Pilot †† Supplied complete with Adaptor 562303 C.P.R. . . Chromium plated rim

# HEADLAMPS, Flush Fitting

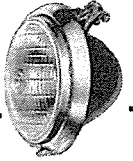

## DETAILED SPARE PARTS

58225A F700 C.P.R.	58226A F700 C.P.R.	58230A/E F700 C.P.R.	58231A/E F700 C.P.R.	†58232A/B F700 C.P.R. (51336)	58235A/D F700 C.P.R.	58236A/B F700 C.P.R.	58237A F700EF C.P.R.	58240A/B F700 C.P.R.	58247A/D F700P C.P.R.	58250A F700 C.P.R.	
554440	554440	554440	554440	554440	556390	556390	556390	556535	554439	—	(1)
198898	198898	198898	198898	198898	198913	198913	198913	198897	198898	—	(2)
161385	161385	161385	161385	161385	161385	161385	161385	161385	161385	—	(3)
—	—	—	—	—	—	—	—	—	—	—	(4)
555704	555704	555704	555704	555704	556362	556362	556362	—	555704	—	(5)
187117	187117	187117	187117	187117	187113	187113	187113	187117	187117	—	(6)
552906	552906	552906	552906	552906	556388	556388	556388	555477	552906	552906	(7)
554872	554872	554872	554872	554872	554872	554872	554872	554872	554872	554179	(8)
186137	186137	186137	186137	186137	186137	186137	186137	186137	186137	198949	(9)
554871	554871	554871	554871	554871	554871	554871	554871	554871	554871	554175	(10)
—	—	—	—	—	—	—	553537	—	—	—	(11)
54520067	54520068	556452	556452	553921	556565	554917	555355	—	555309	—	(12)
—	—	—	—	—	—	—	—	—	—	554180	(13)
—	—	556442	556442	—	—	—	—	—	—	—	(14)
54520187	54520187	553738	553738	554602	554602	554602	562303	553724	554602	553738	(15)
—	—	555910	555910	555910	555910	555910	555910	—	555910	—	(16)
‡554855	‡554855	—	—	—	—	—	—	—	553780	—	(17)
—	—	—	—	—	—	—	‡552943	—	‡554710	—	(18)
—	—	—	—	—	—	—	562306	—	§554354	—	(19)
404	406	410	411	414	414	370	—	—	354 **222	—	(20)
—	—	—	—	—	—	—	—	—	—	—	(21)
555415	555415	554280	554280	554280	556446	556446	556446	554279	554279	554178	(22)
554288	554288	554288	554288	554288	554288	554288	554288	554288	554288	554182	(23)
552813	552813	552813	552813	552813	552813	552813	552813	552813	552813	††554202	(24)
—	—	—	—	—	—	—	—	—	—	—	(25)
—	—	—	—	—	—	—	—	—	—	—	(26)
—	—	—	—	—	—	—	—	—	—	—	(27)
554626	554626	554626	554626	554626	554626	554626	554626	554626	554626	—	(28)
—	—	—	—	—	—	—	—	555541	—	—	(29)
—	—	—	—	—	—	—	—	555447	—	—	(30)
—	—	—	—	—	—	—	—	—	—	199003	(31)

58263A/B F700 C.P.R.	58264A/B F700 C.P.R.	58265A/B F700 C.P.R.	58266A/B F700 C.P.R.	58267A/E F700 C.P.R.	58268A F700 C.P.R.	58269A F700EF C.P.R.	58270A F700 C.P.R.	58271A F700EF C.P.R.	58272A/B F700 C.P.R.	58273A/B F700 C.P.R.	
54520073	54520073	54520073	54520073	554440	556353	556353	554440	554440	554439	554439	(1)
—	—	—	—	198898	198937	198937	198898	198898	198898	198898	(2)
—	—	—	—	161385	161385	161385	161385	161385	161385	161385	(3)
—	—	—	—	—	—	—	—	—	—	—	(4)
—	—	—	—	555704	555704	555704	555704	555704	555704	555704	(5)
—	—	—	—	187117	187117	187117	187117	187117	187117	187117	(6)
552906	552906	552906	552906	552906	552906	552906	552906	552906	552906	552906	(7)
554872	554872	554872	554872	554872	554872	554872	554872	554872	554872	554872	(8)
186137	186137	186137	186137	186137	186137	186137	186137	186137	186137	186137	(9)
554871	554871	554871	554871	554871	554871	554871	554871	554871	554871	554871	(10)
—	—	—	—	—	—	—	—	—	—	—	(11)
555447	553940	553940	554665	555309	556452	556452	556452	556452	556452	556452	(12)
—	—	—	—	—	—	—	—	—	—	—	(13)
—	—	—	—	—	—	—	—	—	—	—	(14)
—	—	—	—	—	556442	556442	556442	556442	556442	556442	(15)
554602	554602	554602	554602	554602	553738	553738	553738	553738	553738	553738	(16)
555910	555910	555910	555910	555910	555910	555910	555910	555910	555910	555910	(17)
—	—	—	—	553780	—	—	—	—	—	—	(18)
—	—	—	—	‡554710	—	—	—	—	—	—	(19)
—	—	—	—	§554354	—	—	—	—	—	—	(20)
355	350	370	370	427 **222	410	411	410	411	410	411	(21)
—	—	—	—	—	—	—	—	—	—	—	(22)
—	—	—	—	—	—	—	—	—	—	—	(23)
554280	554280	554280	554280	554280	556345	556345	555415	555415	554279	554279	(24)
554288	554288	554288	554288	554288	554288	554288	554288	554288	554288	554288	(25)
552813	552813	552813	552813	552813	552813	552813	552813	552813	552813	552813	(26)
—	—	—	—	—	—	—	—	—	—	—	(27)
—	—	—	—	—	—	—	—	—	—	—	(28)
—	—	—	—	—	—	—	—	—	—	—	(29)
—	—	—	—	—	—	—	—	—	—	—	(30)
554626	554626	554626	554626	554626	554626	554626	554626	554626	554626	554626	(31)

For illustrations, see pages G25-G29

† When ordering, quote part number shown in brackets    ‡ Supplied complete with Adaptor 562303    †† Cable and adaptor    ‡ Bulb holder, pilot  
§ Ring, pilot bulb holder seating    \*\* Pilot    †† Spring, trimmer screw retaining    C.P.R.    .. Chromium plated rim

continued

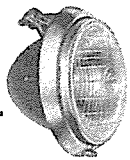

# HEADLAMPS, Flush Fitting

## DETAILED SPARE PARTS

Part No. . . . .		58274A/B	58275A/B	58276A	58277A	58278A	58279A	58280A	58281A
Model . . . . .		F700	F700EF	F700	F700	F700	F700	F700	F700
Finish . . . . .		C.P.R.	C.P.R.	C.P.R.	C.P.R.	C.P.R.	C.P.R.	C.P.R.	C.P.R.
(1)	§Rim or door . . . . .	554982	554982	555747	555747	54520122	54520122	556390	556390
(2)	§ Screw, rim fixing . . . . .	554983	554983	198898	198898	54127511	54127511	198913	198913
(3)	Washer, screw retaining . . . . .	161385	161385	161385	161385	161385	161385	161385	161385
(4)	Motif, top front . . . . .	—	—	—	—	—	—	—	—
(5)	Screw, bracket and motif fixing . . . . .	—	—	—	—	—	—	—	—
(6)	Bracket, rim fixing . . . . .	—	—	555704	555704	—	—	556362	556362
(7)	§Nut, rim fixing screw . . . . .	—	—	187117	187117	—	—	187113	187113
(8)	§Excluder, dust . . . . .	552906	552906	552906	552906	552906	552906	556388	556388
(9)	§Plate, light unit retaining . . . . .	554872	554872	554872	554872	554872	554872	554872	554872
(10)	Screw, unit rim . . . . .	186137	186137	186137	186137	186137	186137	186137	186137
(11)	Rim, unit seating . . . . .	554871	554871	554871	554871	554871	554871	554871	554871
(12)	§Light unit . . . . .	556452	556452	556452	556452	556452	556452	556452	556452
(13)	Spring, light unit fixing . . . . .	—	—	—	—	—	—	—	—
(14)	Screw, plate fixing . . . . .	—	—	—	—	—	—	—	—
(15)	Spring, bulb retaining . . . . .	556442	556442	556442	556442	556442	556442	556442	556442
(16)	§Bulb holder or adaptor . . . . .	553738	553738	553738	553738	553738	553738	553738	553738
(17)	§ Sleeve, terminal . . . . .	555910	555910	555910	555910	555910	555910	555910	555910
(18)	§ Interior, pilot bulb holder . . . . .	—	—	—	—	—	—	—	—
(19)	§Backshell . . . . .	—	—	—	—	—	—	—	—
(20)	Clip and screw, adaptor . . . . .	—	—	—	—	—	—	—	—
(21)	§Bulb, main . . . . .	410	411	410	411	410	411	410	411
(22)	§Buffer, rubber . . . . .	—	—	—	—	—	—	—	—
(23)	Conversion adaptor . . . . .	—	—	—	—	—	—	—	—
(24)	§Gasket, rubber . . . . .	554279	554279	556521	556521	556590	556590	556446	556446
(25)	Screw, with washer . . . . .	554288	554288	554288	554288	554288	554288	554288	554288
(26)	Spring, trimmer . . . . .	552813	552813	552813	552813	552813	552813	552813	552813
(27)	Washer, fixing bolt . . . . .	—	—	—	—	—	—	—	—
(28)	Screw, body fixing . . . . .	—	—	—	—	—	—	—	—
(29)	Nut, fixing bolt . . . . .	—	—	—	—	—	—	—	—
(30)	Sleeve, sealing . . . . .	554626	554626	554626	554626	554626	554626	554626	554626
(31)	Washer, cable grip . . . . .	—	—	—	—	—	—	—	—

Part No. . . . .		58305A/D	58306A/D	58307A	58308A	58315A/E	58319A/B	58327A/B	58329A
Model . . . . .		PF700	PF700	PF700	PF700	F700	F700	F700	F700EF
Finish . . . . .		C.P.R.	C.P.R.	C.P.R.	C.P.R.	C.P.R.	C.P.R.	C.P.R.	C.P.R.
(1)	§Rim or door . . . . .	556606	556606	556606	556606	54520158	54520154	54520154	54520154
(2)	§ Screw, rim fixing . . . . .	554582	554582	554582	554582	198913	198897	198897	198897
(3)	Washer, screw retaining . . . . .	—	—	—	—	161385	161385	161385	161385
(4)	Motif, top front or embellisher . . . . .	—	—	—	—	—	—	—	—
(5)	Screw, embellisher, bracket and fixing . . . . .	116003	116003	116003	116003	—	—	—	—
(6)	Bracket, rim fixing . . . . .	553953	553953	553953	553953	555940	556482	556482	556482
(7)	§Nut, rim fixing screw . . . . .	—	—	—	—	187117	187117	187117	187117
(8)	§Excluder, dust . . . . .	553954	553954	553954	553954	555477	555477	555477	555477
(9)	§Plate, light unit retaining . . . . .	554906	554906	553971	553971	554872	554872	554872	554872
(10)	Screw, unit rim . . . . .	186137	186137	186137	186137	186137	186137	186137	186137
(11)	Rim, unit seating . . . . .	554907	554907	553972	553972	554871	554871	554871	554871
(12)	§Light unit . . . . .	553940	553948	554665	555447	553940	553921	555447	553948
(13)	Screw, plate fixing . . . . .	—	—	—	—	—	—	—	—
(14)	Spring, bulb retaining . . . . .	—	—	—	—	—	—	—	—
(15)	Pivot . . . . .	—	—	—	—	—	—	—	—
(16)	§Bulb holder or adaptor . . . . .	554602	562303	554602	553724	554602	554602	554602	562303
(17)	§ Sleeve, terminal . . . . .	555910	555910	555910	—	555910	555910	555910	555910
(18)	§ Interior, pilot bulb holder . . . . .	‡860895	—	‡860895	—	—	—	—	—
(19)	§Backshell . . . . .	—	‡552943	—	—	—	—	—	‡552943
(20)	Clip and screw, adaptor . . . . .	—	562306	—	—	—	—	—	562306
(21)	§Bulb, main . . . . .	370	—	370	355	370	414	355	—
(22)	Conversion adaptor . . . . .	—	—	—	554691	—	—	—	—
(23)	§Gasket, rubber . . . . .	553955	553955	553955	553955	54520723	54520150	54520150	54520150
(24)	Screw, with washer . . . . .	*552708	*552708	*552708	*552708	554288	554288	554288	554288
(25)	Spring, trimmer . . . . .	553872	553872	553872	553872	552813	552813	552813	552813
(26)	Washer, cupped . . . . .	—	—	—	—	—	—	—	—
(27)	Screw, body fixing . . . . .	117020	117020	117020	117020	—	—	—	—
(28)	Sleeve, sealing . . . . .	554626	554626	554626	554626	554626	554626	554626	554626
(29)	Washer, cable grip . . . . .	553568	—	553568	—	—	—	—	—
(30)	Plate, adaptor . . . . .	—	—	—	—	—	54520271	54520271	54520271
(31)	§Gasket, adaptor plate seating . . . . .	—	—	—	—	—	—	—	—
(32)	Grommet, cable entry . . . . .	—	—	—	—	—	—	—	—

For illustrations, see pages G25–G29

\* See Supersession Chart   † Cable and adaptor   § Recommended spares for stock   ‡ Supplied complete with Adaptor 562303   C.P.R. . . Chromium plated rim



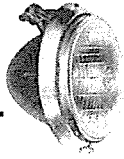

# HEADLAMPS, Flush Fitting

## DETAILED SPARE PARTS

Part No. . . . .		58359A	58360A	58361A	58362A	58363A	58364A	58365A	58366A
Model . . . . .		F700	F700EF	F700	F700	F700	F700	F700	F700
Finish . . . . .		C.P.R.	C.P.R.	—	—	C.P.R.	C.P.R.	C.P.R.	C.P.R.
Replaced by (see footnote)		—	—	—	—	—	—	—	—
(1) §Rim or door . . . . .		555457	555457	556511	556511	555747	555457	556275	556275
(2) § Screw, rim fixing . . . . .		198898	198898	198898	198898	198898	198898	198898	198898
(3) Washer, screw retaining . . . . .		161385	161385	161385	161385	161385	161385	161385	161385
(4) Motif, top front or embellisher . . . . .		—	—	556503	556503	—	—	—	—
(5) Screw, embellisher, bracket and motif fixing . . . . .		—	—	198948	198948	—	—	—	—
(6) Bracket, rim fixing . . . . .		555704	555704	555704	555704	555704	555704	555704	555704
(7) §Nut, rim fixing screw . . . . .		187117	187117	187117	187117	187117	187117	187117	187117
(8) §Excluder, dust . . . . .		552906	552906	552906	552906	552906	552906	552906	552906
(9) §Plate, light unit retaining . . . . .		554872	554872	554872	554872	554872	554872	554872	554872
(10) Screw, unit rim . . . . .		186137	186137	186137	186137	186137	186137	186137	186137
(11) Rim, unit seating . . . . .		554871	554871	554871	554871	554871	554871	554871	554871
(12) §Light unit . . . . .		556452	556452	556452	556452	556452	556452	556452	556452
(13) Spring, light unit fixing . . . . .		—	—	—	—	—	—	—	—
(14) Spring, bulb retaining . . . . .		556442	556442	556442	556442	556442	556442	556442	556442
(15) §Bulb holder or adaptor . . . . .		553738	553738	553738	553738	553738	553738	553738	553738
(16) § Sleeve, terminal . . . . .		555910	555910	555910	555910	555910	555910	555910	555910
(17) § Interior, pilot bulb holder . . . . .		—	—	—	—	—	—	—	—
(18) §Backshell . . . . .		—	—	—	—	—	—	—	—
(19) Clip and screw, adaptor . . . . .		—	—	—	—	—	—	—	—
(20) §Bulb, main . . . . .		410	411	410	411	410	411	410	411
(21) Conversion adaptor . . . . .		—	—	—	—	—	—	—	—
(22) §Gasket, rubber . . . . .		555458	555458	555458	555458	555458	555458	555458	555458
(23) Screw, with washer . . . . .		554288	554288	554288	554288	554288	554288	554288	554288
(24) Spring, trimmer . . . . .		552813	552813	552813	552813	552813	552813	552813	552813
(25) Screw, motif fixing . . . . .		—	—	—	—	—	—	—	—
(26) Washer, spring . . . . .		—	—	—	—	—	—	—	—
(27) Screw, body fixing . . . . .		—	—	—	—	—	—	—	—
(28) Sleeve, sealing . . . . .		554626	554626	554626	554626	554626	554626	554626	554626
(29) §Plate, adaptor . . . . .		—	—	—	—	—	—	—	—
(30) §Gasket, adaptor plate seating . . . . .		—	—	—	—	—	—	—	—

Part No. . . . .		58412A	58415A	58433A/B	58434A/B	58435A/B	58436A/B	58437A/B	58438A/B
Model . . . . .		F700	F700VF	F700	F700	F700	F700EF	F700EF	F700
Finish . . . . .		C.P.R.	C.P.R.	—	—	—	—	—	—
Replaced by (see footnote)		—	—	—	—	—	—	—	—
(1) §Rim or door . . . . .		54520443	556537	556498	556498	556498	556498	556498	556498
(2) § Screw, rim fixing . . . . .		—	100051	198898	198898	198898	198898	198898	198898
(3) Washer, screw retaining . . . . .		—	161385	161385	161385	161385	161385	161385	161385
(4) Motif, top front . . . . .		—	—	‡556499	‡556499	‡556499	‡556499	‡556499	‡556499
(5) Bracket, rim fixing . . . . .		—	—	556482	556482	556482	556482	556482	556482
(6) §Nut, rim fixing screw . . . . .		—	—	187117	187117	187117	187117	187117	187117
(7) §Excluder, dust . . . . .		552906	—	556544	556544	556544	556544	556544	556544
(8) §Plate, light unit retaining . . . . .		554179	—	554872	554872	554872	554872	554872	554872
(9) Screw, unit rim . . . . .		186134	—	186137	186137	186137	186137	186137	186137
(10) Rim, unit seating . . . . .		554175	—	554871	554871	554871	554871	554871	554871
(11) §Light unit . . . . .		—	553921	553921	553921	553940	553948	556452	556452
(12) Spring, light unit fixing . . . . .		‡554180	504665	—	—	—	—	—	—
(13) Spring, bulb retaining . . . . .		—	—	—	—	—	—	556442	556442
(14) Bung, rubber, pivot . . . . .		—	—	—	—	—	—	—	—
(15) §Bulb holder or adaptor . . . . .		553724	554602	554602	554602	554602	562303	553738	553738
(16) § Sleeve, terminal . . . . .		—	555910	555910	555910	555910	555910	555910	555910
(17) § Interior, pilot bulb holder . . . . .		—	—	—	—	—	—	—	—
(18) §Backshell . . . . .		—	—	—	—	—	§552943	—	—
(19) Clip and screw, adaptor . . . . .		—	—	—	—	—	562306	—	—
(20) §Bulb, main . . . . .		—	354	414	355	370	—	411	410
(21) §Buffer, rubber . . . . .		—	—	—	—	—	—	—	—
(22) Conversion adaptor . . . . .		—	—	—	—	—	—	—	—
(23) §Gasket, rubber . . . . .		554178	—	554279	554279	554279	556492	556492	556492
(24) Screw, with washer . . . . .		554182	—	554288	554288	554288	554288	554288	554288
(25) Spring, trimmer . . . . .		‡554202	—	552813	552813	552813	552813	552813	552813
(26) Screw, motif fixing . . . . .		—	—	—	—	—	—	—	—
(27) Washer, spring . . . . .		—	—	—	—	—	—	—	—
(28) Screw, body fixing . . . . .		—	—	—	—	—	—	—	—
(29) Sleeve, sealing . . . . .		—	—	554626	554626	554626	554626	554626	554626
(30) §Gasket, body . . . . .		—	—	—	—	—	554279	554279	554279
(31) §Gasket, adaptor plate seating . . . . .		—	—	556492	556492	556492	—	—	—

For illustrations, see pages G25-G29

Note. For replacement lamp spare parts, see appropriate column under part number  
 § Recommended spares for stock

‡ When ordering, quote part number shown in brackets  
 † Spring, unit seating rim fixing  
 ‡ Bracket locating rim  
 § Supplied complete with Adaptor 562303  
 C.P.R. . . . Chromium plated rim

# HEADLAMPS, Flush Fitting

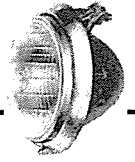

## DETAILED SPARE PARTS

58369A F700 C.P.R. —	58370A F700 C.P.R. —	†58375A/D F700 C.P.R. (58465)	58388A/F F700P C.P.R. —	58390A PF700 C.P.R. —	58400A/D F700 C.P.R. —	58402A/B F700 C.P.R. —	58403B/D F700 —	58405A/B F700 —	58406A/B F700 —	58407A/B F700 —	
555974	555974	556563	554440	556606	554439	555770	54520411	54520411	54520411	54520411	(1)
113061	113061	—	198898	554582	198898	198913	198898	198898	198898	198898	(2)
161385	161385	—	161385	—	161385	161385	161385	161385	161385	161385	(3)
—	—	—	—	—	—	—	—	—	—	—	(4)
—	—	—	—	116003	—	—	—	—	—	—	(5)
—	—	—	555704	553953	555704	—	555704	555704	555704	555704	(6)
—	—	—	187117	—	187117	187117	187117	187117	187117	187117	(7)
552906	552906	552906	552906	553954	552906	555477	552906	552906	552906	552906	(8)
554872	554872	554872	554872	553971	554872	554872	554872	554872	554872	554872	(9)
186137	186137	186137	186137	186137	186137	186137	186137	186137	186137	186137	(10)
554871	554871	554871	554871	553972	554871	554871	554871	554871	554871	554871	(11)
556452	556452	553921	555309	556599	553921	—	554308	556452	556452	—	(12)
—	—	—	—	—	—	—	—	—	—	—	(13)
556442	556442	—	—	556442	—	—	—	556442	556442	—	(14)
553738	553738	554602	554602	553738	554602	553724	554602	553738	553738	553724	(15)
555910	555910	555910	555910	555910	555910	—	555910	555910	555910	555910	(16)
—	—	—	553780	—	—	—	—	—	—	—	(17)
—	—	—	‡554710	—	—	—	—	—	—	—	(18)
—	—	—	‡554354	—	—	—	—	—	—	—	(19)
410	411	414	414 ¶1989	416	418	—	414	411	410	—	(20)
—	—	—	—	—	—	—	—	—	—	—	(21)
556247	556247	554279	554280	553955	554279	554279	555458	555458	555458	555458	(22)
554288	554288	554288	554288	*552708	554288	554288	554288	554288	554288	554288	(23)
552813	552813	552813	552813	553872	552813	552813	552813	552813	552813	552813	(24)
—	—	—	—	—	—	—	—	—	—	—	(25)
—	—	—	—	—	—	—	—	—	—	—	(26)
—	—	—	—	117020	—	—	—	—	—	—	(27)
554626	554626	554626	554626	554626	554626	554626	554626	554626	554626	554626	(28)
—	—	—	—	—	—	555541	—	—	—	—	(29)
—	—	—	—	—	—	555787	—	—	—	—	(30)

58440A F700 —	58443A/D F700 C.P.R. —	58444B/D F700 C.P.R. —	58445A/D F700 C.P.R. —	58446A/D F700 C.P.R. —	58447A/D F700EF C.P.R. —	58450A F700 C.P.R. —	58451A/B F700 C.P.R. —	58452A/B F700 C.P.R. —	58453A F700 C.P.R. —	58454A F700 C.P.R. —	
556498	54520158	54520158	54520158	54520158	54520158	554440	554439	554982	555747	556353	(1)
198898	198913	198913	198913	198913	198913	198898	198898	554983	198898	198937	(2)
161385	161385	161385	161385	161385	161385	161385	161385	161385	161385	161385	(3)
§556499	—	—	—	—	—	—	—	—	—	—	(4)
556482	555940	555940	555940	555940	555940	555704	555704	—	555704	555704	(5)
187117	187117	187117	187117	187117	187117	187117	187117	—	187117	187117	(6)
556544	—	—	—	—	—	552906	552906	552906	552906	552906	(7)
554179	554872	554872	554872	554872	554872	554872	554872	554872	554872	554872	(8)
186134	186137	186137	186137	186137	186137	186137	186137	186137	186137	186137	(9)
554175	554871	554871	554871	554871	554871	554871	554871	554871	554871	554871	(10)
—	553921	555447	556452	54520148	556452	54520148	54520148	54520148	54520148	54520148	(11)
**554180	—	—	—	—	—	—	—	—	—	—	(12)
—	—	—	556442	556442	556442	556442	556442	556442	556442	556442	(13)
—	—	—	—	—	—	—	—	—	—	—	(14)
553738	554602	554602	553738	553738	553738	553738	553738	553738	553738	553738	(15)
—	555910	555910	555910	555910	555910	555910	555910	555910	555910	555910	(16)
—	—	—	—	—	—	—	—	—	—	—	(17)
—	—	—	—	—	—	—	—	—	—	—	(18)
—	—	—	—	—	—	—	—	—	—	—	(19)
—	414	355	410	410	411	410	410	410	410	410	(20)
—	—	—	—	—	—	—	—	—	—	—	(21)
—	—	—	—	—	—	—	—	—	—	—	(22)
—	—	—	—	—	—	—	—	—	—	—	(23)
554182	554288	554288	554288	554288	554288	554288	554288	554288	554288	554288	(24)
††554202	552813	552813	552813	552813	552813	552813	552813	552813	552813	552813	(25)
—	—	—	—	—	—	—	—	—	—	—	(26)
—	—	—	—	—	—	—	—	—	—	—	(27)
—	—	—	—	—	—	—	—	—	—	—	(28)
—	554626	554626	554626	554626	554626	554626	554626	554626	554626	554626	(29)
554227	54520723	54520723	54520723	54520723	54520723	555415	554279	554279	556521	556345	(30)
—	—	—	—	—	—	—	—	—	—	—	(31)

For illustrations, see pages G25-G29

\* See Supersession Chart † When ordering, quote part number shown in brackets ‡ Bulb holder, pilot  
 ¶ Pilot § Bracket locating rim \*\* Spring, unit seating rim fixing †† Spring, trimmer screw retaining C.P.R. . . . Chromium plated rim

continued

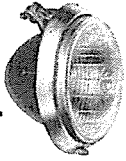

# HEADLAMPS, Flush Fitting

## DETAILED SPARE PARTS

Part No. . . . .	58455A F700 C.P.R.	58456A/B F700 C.P.R.	58457A F700 C.P.R.	58458A/B F700 C.P.R.	58459A/B F700 C.P.R.	58460A/D F700 C.P.R.	58462A PF700 C.P.R.	58463A/B F700 C.P.R.
Replaced by (see footnote)	—	—	—	—	—	—	—	—
(1) §Rim or door . . . . .	54520122	554440	556432	554440	554439	556563	556027	556234
(2) § Screw, rim fixing . . . . .	54127511	198898	198913	198898	198898	119811	552796	198898
(3) Washer, screw retaining . . . . .	161385	161385	161385	161385	161385	161385	161385	161385
(4) Motif, top front or embellisher	—	—	—	—	—	—	—	—
(5) Screw, embellisher, bracket and motif fixing . . . . .	—	—	—	—	—	—	116003	—
(6) Bracket, rim fixing . . . . .	—	555704	556362	555704	555704	—	553953	555704
(7) §Nut, rim fixing screw . . . . .	—	187117	187113	187117	187117	—	—	187117
(8) §Excluder, dust . . . . .	552906	552906	556388	552906	552906	—	554459	552906
(9) §Plate, light unit retaining . . . . .	554872	554872	554872	554872	554872	554872	554906	554872
(10) Screw, unit rim . . . . .	186137	186137	186137	186137	186137	186137	186137	186137
(11) Rim, unit seating . . . . .	554871	554871	554871	554871	554871	554871	554907	554871
(12) Piece, packing . . . . .	—	—	—	—	—	—	—	—
(13) §Light unit . . . . .	54520148	54520148	54520148	54520148	54520148	54520148	54520148	54520148
(14) Spring, light unit fixing . . . . .	—	—	—	—	—	—	—	—
(15) Spring, bulb retaining . . . . .	556442	556442	556442	556442	556442	556442	556442	556442
(16) §Bulb holder or adaptor . . . . .	553738	553738	553738	553738	553738	553738	553738	553738
(17) § Sleeve, terminal . . . . .	555910	555910	555910	555910	555910	555910	555910	555910
(18) §Bulb, main . . . . .	410	410	410	410	410	410	410	410
(19) §Buffer, rubber . . . . .	—	—	—	—	—	—	—	—
(20) Conversion adaptor . . . . .	—	—	—	—	—	—	—	—
(21) §Gasket, rubber . . . . .	—	—	—	554280	554279	554279	553955	554280
(22) Screw, with washer . . . . .	554288	554288	554288	554288	554288	554288	*552708	554288
(23) Spring, trimmer . . . . .	552813	552813	552813	552813	552813	552813	553872	552813
(24) Screw, motif fixing . . . . .	—	—	—	—	—	—	—	—
(25) Washer, spring . . . . .	—	—	—	—	—	—	—	—
(26) Screw, body fixing . . . . .	—	—	—	—	—	—	117020	—
(27) Sleeve, sealing . . . . .	554626	554626	554626	554626	554626	554626	554626	554626
(28) §Gasket, body . . . . .	556590	554280	556446	—	—	—	—	—
(29) Plate, adaptor . . . . .	—	—	—	—	—	—	—	—
(30) §Gasket, adaptor plate seating . . . . .	—	—	—	—	—	—	—	—

Part No. . . . .	58493A F700 C.P.R.	†58494A/B F700 C.P.R. (58567)	†58495A/B F700 C.P.R. (58568)	†58497A/B F700 C.P.R. (58493)	†58499A/B F700 C.P.R. (58570)	†58521A/B F700 C.P.R. (51336)	†58522A/B F700 C.P.R. (51509)	†58523A/B F700 C.P.R. (58230)
Replaced by (see footnote)	—	—	—	—	—	—	—	—
(1) §Rim or door . . . . .	54520650	556563	555747	54520650	54520651	554440	554440	554440
(2) § Screw, rim fixing . . . . .	198898	119811	198898	198898	198898	198898	198898	198898
(3) Washer, screw retaining . . . . .	161385	161385	161385	161385	161385	161385	161385	161385
(4) Motif, top front or embellisher	—	—	—	—	—	—	—	—
(5) Screw, embellisher, bracket and motif fixing . . . . .	—	—	—	—	—	—	—	—
(6) Bracket, rim fixing . . . . .	555704	—	555704	555704	555704	555704	555704	555704
(7) §Nut, rim fixing screw . . . . .	187117	—	187117	187117	187117	187117	187117	187117
(8) §Excluder, dust . . . . .	—	—	—	—	—	552906	552906	552906
(9) §Plate, light unit retaining . . . . .	554179	554179	554179	554179	554179	554872	554872	554872
(10) Screw, unit rim . . . . .	186134	186134	186134	186134	186134	186137	186137	186137
(11) Rim, unit seating . . . . .	554175	554175	554175	554175	554175	554871	554871	554871
(12) Piece, packing . . . . .	—	—	—	—	—	—	—	—
(13) §Light unit . . . . .	—	—	—	—	—	553921	555447	556452
(14) Spring, light unit fixing . . . . .	‡554180	‡554180	‡554180	‡554180	‡554180	—	—	—
(15) Spring, bulb retaining . . . . .	—	—	—	—	—	—	—	556442
(16) §Bulb holder or adaptor . . . . .	553738	553738	553738	553738	553738	554602	554602	553738
(17) § Sleeve, terminal . . . . .	—	—	—	—	—	555910	555910	555910
(18) §Bulb, main . . . . .	—	—	—	—	—	414	355	410
(19) §Buffer, rubber . . . . .	—	—	—	—	—	—	—	—
(20) Conversion adaptor . . . . .	—	—	—	—	—	—	—	—
(21) §Gasket, rubber . . . . .	554178	554227	54520670	554178	554227	554280	554280	554280
(22) Screw, with washer . . . . .	554182	554182	554182	554182	554182	554288	554288	554288
(23) Spring, trimmer . . . . .	‡554202	‡554202	‡554202	‡554202	‡554202	552813	552813	552813
(24) Screw, special, dip adjusting . . . . .	—	—	—	—	—	—	—	—
(25) Washer, cupped . . . . .	—	—	—	—	—	—	—	—
(26) Screw, body fixing . . . . .	—	—	—	—	—	—	—	—
(27) Sleeve, sealing . . . . .	—	—	—	—	—	554626	554626	554626
(28) §Plate, adaptor . . . . .	—	—	—	—	—	—	—	—
(29) §Gasket, adaptor plate seating . . . . .	—	—	—	—	—	—	—	—
(30) Bracket, rim seating . . . . .	—	—	—	—	—	—	—	—

For illustrations, see pages G25-G29

Note. For replacement lamp spare parts, see appropriate column under part number \* See Supersession Chart † When ordering, quote part number shown in brackets ‡ Spring, unit seating rim fixing § Recommended spares for stock || Spring, trimmer screw retaining C.P.R. Chromium plated rim



# HEADLAMPS, Flush Fitting

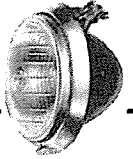

## DETAILED SPARE PARTS

58465A/D F700 C.P.R.	58466A/D F700 C.P.R.	58467A/D F700 C.P.R.	58468A/D F700EF C.P.R.	58469A F700 C.P.R.	†58474A/B F700 C.P.R. (58563)	†58476A/B F700 C.P.R. (58564)	58486A/B PL700 C.P.R.	†58488A/D F700 C.P.R. (58566)	58491A F700 C.P.R.	58392A F700 C.P.R.	
556563	556563	556563	556563	54520154	54520651	556420	555974	54520158	556511	555974	(1)
119811	119811	119811	119811	198897	198898	—	113061	198913	198898	113061	(2)
161385	161385	161385	161385	161385	161385	—	161385	161385	161385	161385	(3)
—	—	—	—	—	—	—	—	—	556503	—	(4)
—	—	—	—	—	—	—	—	—	198948	—	(5)
—	—	—	—	556482	555704	—	555704	555940	555704	—	(6)
—	—	—	—	187117	187117	—	187117	187117	187117	—	(7)
—	—	—	—	555477	—	552906	552906	—	—	—	(8)
554872	554872	554872	554872	554179	554179	554179	554872	554179	554179	554179	(9)
186137	186137	186137	186137	186134	186134	186134	186137	186134	186134	186134	(10)
554871	554871	554871	554871	554175	554175	554175	554871	554175	554175	554175	(11)
—	—	—	—	—	—	—	—	—	—	—	(12)
553921	555447	556452	556452	—	—	—	556599	—	—	—	(13)
—	—	—	—	‡554180	‡554180	‡554180	—	‡554180	‡554180	‡554180	(14)
—	—	556442	556442	—	—	—	556442	—	—	—	(15)
554602	554602	553738	553738	553738	553738	553738	553738	553738	553738	553738	(16)
555910	555910	555910	555910	—	—	—	555910	—	—	—	(17)
414	355	410	411	—	—	—	416	—	—	—	(18)
—	—	—	—	—	—	—	—	—	—	—	(19)
—	—	—	—	—	—	—	—	—	—	—	(20)
554279	554279	554279	554279	—	554227	54520576	556247	54520512	54520582	54520674	(21)
554288	554288	554288	554288	554182	554182	554182	554288	554182	554182	554182	(22)
552813	552813	552813	552813	‡554202	‡554202	‡554202	552813	‡554202	‡554202	‡554202	(23)
—	—	—	—	—	—	—	—	—	—	—	(24)
—	—	—	—	—	—	—	—	—	—	—	(25)
—	—	—	—	—	—	—	—	—	—	—	(26)
554626	554626	554626	554626	—	—	—	554626	—	—	—	(27)
—	—	—	—	—	—	—	—	—	—	—	(28)
—	—	—	—	54520271	—	556491	—	—	—	—	(29)
—	—	—	—	54520150	—	—	—	—	—	—	(30)

†58524A/B F700 C.P.R. (58231)	†58525A F700 C.P.R. (58456)	†58526A/B F700 C.P.R. (58571)	†58527A/D F700 C.P.R. (58572)	58541B F700 C.P.R.	58542B/E RL700 C.P.R.	58543B F700 C.P.R.	†58545B F700 C.P.R. (58446)	†58546A/D F700 C.P.R. (58669)	58548A/B F700	58549A F700	
554440	554440	54520650	54520158	555326	54521032	555326	54520158	554903	54520411	54520411	(1)
198898	198898	198898	198913	144471	144471	144471	198913	552796	198898	198898	(2)
161385	161385	161385	161385	161385	161385	161385	161385	—	161385	161385	(3)
—	—	—	—	¶555332	¶555332	¶555332	—	554905	—	—	(4)
—	—	—	—	—	—	—	—	116003	—	—	(5)
555704	555704	555704	555940	554240	554240	554240	555940	552691	555704	555704	(6)
187117	187117	187117	187117	—	—	—	187117	—	187117	187117	(7)
552906	552906	—	—	555333	555333	555333	—	—	552906	—	(8)
554872	554872	554179	554179	555351	555351	555351	554872	554179	554872	554179	(9)
186137	186137	186134	186134	186137	186137	186137	186137	186134	186137	186134	(10)
554871	554871	554175	554175	554871	554871	554871	554871	554175	554871	554175	(11)
—	—	—	—	—	—	—	—	—	—	—	(12)
556452	54520148	—	—	556452	—	54520148	54520148	—	553921	—	(13)
—	—	‡554180	‡554180	—	—	—	—	‡554180	—	‡554180	(14)
556442	556442	—	—	556442	—	556442	556442	—	—	—	(15)
553738	553738	553738	553738	54945781	54945781	54945781	553738	553738	554602	553738	(16)
555910	555910	—	—	—	—	—	555910	—	555910	—	(17)
411	410	—	—	410	—	410	410	—	414	—	(18)
—	—	—	—	—	—	—	—	—	—	—	(19)
—	—	—	—	—	—	—	—	—	—	—	(20)
554280	554280	554178	54520512	554279	554279	554279	54520723	54520607	555458	54520582	(21)
554288	554288	554182	554182	555344	555344	555344	554288	554182	554288	554182	(22)
552813	552813	‡554202	‡554202	553872	553872	553872	552813	‡554202	552813	‡554202	(23)
—	—	—	—	555328	555328	555328	—	—	—	—	(24)
—	—	—	—	556509	556509	556509	—	—	—	—	(25)
—	—	—	—	—	—	—	—	—	—	—	(26)
554626	554626	—	—	554626	554626	554626	554626	—	554626	—	(27)
—	—	—	—	—	—	—	—	—	—	—	(28)
—	—	—	—	—	—	—	—	54520598	—	—	(29)
—	—	—	—	—	—	—	—	54520599	—	—	(30)

For illustrations, see pages G25-G29

† When ordering, quote part number shown in brackets    ‡ Spring, unit seating rim fixing    ¶ Spring, trimmer screw retaining  
 ¶ Gasket, rim seating    C.P.R. ... Chromium plated rim

continued

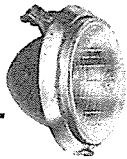

# HEADLAMPS, Flush Fitting

## DETAILED SPARE PARTS

Part No. . . . .	58550A F700	58553A/B F700 C.P.R.	58560A F700 C.P.R.	58561A F700EF C.P.R.	58563A F700 C.P.R.	58564A F700 C.P.R.	58566A F700 C.P.R.
Model . . . . .	—	—	—	—	—	—	—
Finish . . . . .	—	—	—	—	—	—	—
Replaced by (see footnote) . . . . .	—	—	—	—	—	—	—
(1) §Rim or door . . . . .	556511	555326	54520073	54520073	54520651	556420	54520158
(2) § Screw, rim fixing . . . . .	198898	101750	—	—	198898	—	198913
(3) Washer, screw retaining . . . . .	161385	161385	—	—	161385	—	161385
(4) Motif, top front or embellisher . . . . .	556503	—	—	—	—	—	—
(5) Screw, embellisher, bracket and motif fixing . . . . .	198948	—	—	—	—	—	—
(6) Bracket, rim fixing . . . . .	555704	555704	—	—	555704	—	555940
(7) §Nut, rim fixing screw . . . . .	187117	187117	—	—	187117	—	187117
(8) §Excluder, dust . . . . .	552906	—	552906	552906	—	552906	—
(9) §Plate, light unit retaining . . . . .	554872	554179	554872	554872	554179	554179	554179
(10) Screw, unit rim . . . . .	186137	186134	186137	186137	186134	186134	186134
(11) Rim, unit seating . . . . .	554871	554175	554871	554871	554175	554175	554175
(12) §Light unit . . . . .	553921	—	556452	556452	—	—	—
(13) Spring, light unit fixing . . . . .	—	‡554180	—	—	‡554180	‡554180	‡554180
(14) Spring, bulb retaining . . . . .	—	—	556442	556442	—	—	—
(15) §Bulb holder or adaptor . . . . .	554602	54945781	553738	553738	553738	553738	553738
(16) § Sleeve, terminal . . . . .	555910	—	555910	555910	—	—	—
(17) § Interior, pilot bulb holder . . . . .	—	—	—	—	—	—	—
(18) §Backshell . . . . .	—	—	—	—	—	—	—
(19) §Bulb, main . . . . .	414	—	410	411	—	—	—
(20) §Buffer, rubber . . . . .	—	199002	—	—	—	—	—
(21) §Gasket, rubber . . . . .	555458	554178	554280	554280	554227	54520576	54520512
(22) Screw, with washer . . . . .	554288	554182	554288	554288	554182	554182	554182
(23) Spring, trimmer . . . . .	552813	¶554202	552813	552813	¶554202	¶554202	¶554202
(24) Screw, special, dip adjusting . . . . .	—	—	—	—	—	—	—
(25) Washer, cupped . . . . .	—	—	—	—	—	—	—
(26) Screw, body fixing . . . . .	—	—	—	—	—	—	—
(27) Sleeve, sealing . . . . .	554626	—	554626	554626	—	—	—
(28) §Plate, adaptor . . . . .	—	—	—	—	—	554691	—
(29) Bracket, rim securing . . . . .	—	—	—	—	—	—	—
(30) Washer, cable grip . . . . .	—	—	—	—	—	—	—

Part No. . . . .	58589A F700 C.P.R.	58608A F700	58609A F700 C.P.R.	58610A F700 C.P.R.	58611A/B F700P C.P.R.	58612A F700	58613A F700 C.P.R.
Model . . . . .	—	—	—	—	—	—	—
Finish . . . . .	—	—	—	—	—	—	—
Replaced by (see footnote) . . . . .	—	—	—	—	—	—	—
(1) §Rim or door . . . . .	556420	556511	555974	554440	555326	556498	554440
(2) § Screw, rim fixing . . . . .	—	198898	113061	198898	144471	198898	198898
(3) Washer, screw retaining . . . . .	—	161385	161385	161385	161385	161385	161385
(4) Motif, top front or embellisher . . . . .	—	556503	—	—	§555332	**556492	—
(5) Screw, embellisher, bracket and motif fixing . . . . .	—	198948	—	—	—	††556499	—
(6) Bracket, rim fixing . . . . .	—	555704	—	555704	554240	556482	555704
(7) §Nut, rim fixing screw . . . . .	—	187117	—	187117	—	187117	187117
(8) §Excluder, dust . . . . .	552906	552906	552906	552906	555333	556544	552906
(9) §Plate, light unit retaining . . . . .	554872	554872	554872	554872	555351	554872	554872
(10) Screw, unit rim . . . . .	186137	186137	186137	186137	186137	186137	186137
(11) Rim, unit seating . . . . .	554871	554871	554871	554871	554871	554871	554871
(12) §Light unit . . . . .	54520148	54520148	54520148	54520148	54520420	54520882	54520882
(13) Spring, light unit fixing . . . . .	—	—	—	—	—	—	—
(14) Spring, bulb retaining . . . . .	556442	556442	556442	556442	556442	—	—
(15) §Bulb holder or adaptor . . . . .	553738	553738	553738	553738	54946410	554602	554602
(16) § Sleeve, terminal . . . . .	555910	555910	555910	555910	‡‡554710	555910	555910
(17) Interior, pilot bulb holder . . . . .	—	—	—	—	553780	—	—
(18) §Backshell . . . . .	—	—	—	—	§§554354	—	—
(19) §Bulb, main . . . . .	410	410	410	410	¶¶1989 410	370	370
(20) §Gasket, rubber . . . . .	556422	555458	556247	555415	554279	554279	554280
(21) Screw, with washer . . . . .	554288	554288	554288	554288	555344	554288	554288
(22) Spring, trimmer . . . . .	552813	552813	552813	552813	553872	552813	552813
(23) Washer, cupped . . . . .	—	—	—	—	556509	—	—
(24) Screw, special, dip adjusting . . . . .	—	—	—	—	555328	—	—
(25) Housing, trimmer screw . . . . .	—	—	—	—	—	—	—
(26) Nut, trimmer screw . . . . .	—	—	—	—	—	—	—
(27) Bracket, rim securing . . . . .	—	—	—	—	—	—	—
(28) Sleeve, sealing . . . . .	554626	554626	554626	554626	554626	554626	554626
(29) §Plate, adaptor . . . . .	556491	—	—	—	—	—	—
(30) Washer, cable grip . . . . .	—	—	—	—	—	—	—

For illustrations, see pages G25–G29

Note. For replacement lamp spare parts, see appropriate column under part number  
 † Spring, unit securing rim fixing § Recommended spares for stock  
 ‡ Spring, trimmer screw retaining ¶ Gasket, rim seating \*\* Gasket, rubber †† Bracket, rim locating ‡‡ Bulb holder, pilot  
 §§ Ring, pilot bulb holder seating ¶¶ Pilot C.P.R. . . . Chromium plated rim

# HEADLAMPS, Flush Fitting

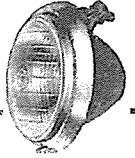

## DETAILED SPARE PARTS

58567A F700 C.P.R.	58568A F700 C.P.R.	58569A F700 C.P.R.	58570A F700 C.P.R.	58571A F700 C.P.R.	58572A F700 C.P.R.	†58576A/B F700 C.P.R. (58572)	58581A PL700 C.P.R.	58585A F700 C.P.R.	58588A PF700 C.P.R.	
556563	555747	54520673	54520651	54520650	54520158	54520810	54520158	552913	554903	(1)
119811	198898	198898	198898	198898	198913	554582	198913	552816	552796	(2)
161385	161385	161385	161385	161385	161385	—	161385	—	—	(3)
—	—	—	—	—	—	—	—	—	554905	(4)
—	—	—	—	—	—	116003	—	—	116003	(5)
—	555704	555704	555704	555704	555940	555953	555940	—	552691	(6)
—	187117	187117	187117	187117	187117	—	187117	—	—	(7)
—	—	—	—	—	—	—	—	552906	554459	(8)
554179	554179	554179	554179	554179	554179	554179	554782	554872	554906	(9)
186134	186134	186134	186134	186134	186134	186134	186137	186137	186137	(10)
554175	554175	554175	554175	554175	554175	554175	554871	554871	554907	(11)
—	—	—	—	—	—	—	556599	54520148	556452	(12)
‡554180	‡554180	‡554180	‡554180	‡554180	‡554180	‡554180	—	—	—	(13)
—	—	—	—	—	—	—	556442	556442	556442	(14)
553738	553738	553738	553738	553738	553738	553738	553738	553738	553738	(15)
—	—	—	—	—	—	—	555910	555910	555910	(16)
—	—	—	—	—	—	—	—	—	—	(17)
—	—	—	—	—	—	—	—	—	—	(18)
—	—	—	—	—	—	—	416	410	411	(19)
—	—	—	—	—	—	—	—	—	—	(20)
554227	54520670	554178	554227	554178	54520512	54520607	54520723	552915	553955	(21)
554182	554182	554182	554182	554182	554182	554182	554288	554288	*552708	(22)
554202	554202	554202	554202	554202	554202	554202	552813	552813	553872	(23)
—	—	—	—	—	—	—	—	—	—	(24)
—	—	—	—	—	—	—	—	—	—	(25)
—	—	—	—	—	—	—	—	—	117020	(26)
—	—	—	—	—	—	—	554626	554626	554626	(27)
—	—	—	—	—	—	—	—	—	—	(28)
—	—	—	—	—	—	54520599	—	—	—	(29)
—	—	—	—	—	—	54520598	—	—	—	(30)

†58617A F700 C.P.R. (58773)	58618A F700 C.P.R.	†58619A F700 C.P.R. (58772)	†58620A F700 C.P.R. (58734)	†58623A F700 C.P.R. (58733)	†58626A F700 C.P.R. (58776)	58631A F700 C.P.R.	58632A PF700 C.P.R.	58633A PF700 C.P.R.	58634A F700 C.P.R.	
554439	554440	54520122	54520158	556563	54520673	54520073	554903	554903	554440	(1)
198898	198898	54127511	198913	—	198898	—	552796	552796	198898	(2)
161385	161385	161385	161385	—	161385	—	—	—	161385	(3)
—	—	—	—	—	—	—	554905	554905	—	(4)
—	—	—	—	—	—	—	116003	116003	—	(5)
555704	555704	—	555940	—	555704	—	552691	552691	555704	(6)
187117	187117	—	187117	—	187117	—	—	—	187117	(7)
—	—	—	—	—	—	552906	554459	554459	552906	(8)
54520549	54520549	54520549	54520549	54520549	54520549	554872	554906	554906	554872	(9)
186137	186137	186137	186137	186137	186137	186137	186137	186137	186137	(10)
—	54520446	54520446	54520446	54520446	54520446	554871	554907	554907	554871	(11)
54521060	54520514	54520514	54520514	54520514	54520514	54520148	54520148	54520883	54520883	(12)
54520514	—	—	—	—	—	—	—	—	—	(13)
—	—	—	—	—	—	556442	556442	556442	556442	(14)
553738	553738	553738	553738	553738	553738	553738	553738	553738	553738	(15)
—	—	—	—	—	—	555910	555910	555910	555910	(16)
—	—	—	—	—	—	—	—	—	—	(17)
—	—	—	—	—	—	—	—	—	—	(18)
—	—	—	—	—	—	410	410	410	410	(19)
54520505	54520919	54520508	54520512	54520505	54520919	554280	553955	553955	555415	(20)
54520451	54520451	54520451	54520451	54520451	54520451	554288	*552708	*552708	554288	(21)
—	—	54520514	54520514	54520514	54520514	552813	553872	553872	552813	(22)
—	—	—	—	—	—	—	—	—	—	(23)
—	—	—	—	—	—	—	¶117020	¶117020	—	(24)
54520550	54520550	54520550	54520550	54520550	54520550	—	—	—	—	(25)
54520551	54520551	54520551	54520551	54520551	54520551	—	—	—	—	(26)
—	—	—	—	—	—	—	—	—	—	(27)
—	—	—	—	—	—	554626	554626	554626	554626	(28)
—	—	—	—	—	—	—	—	—	—	(29)
—	—	—	—	—	—	—	553568	553568	—	(30)

For illustrations, see pages G25-G29

\* See Supersession Chart    † When ordering, quote part number shown in brackets    ‡ Spring, unit securing rim seating    ¶ Spring, trimmer screw retaining  
 ¶ Screw, body fixing    C.P.R. ... Chromium plated rim

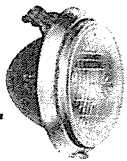

# HEADLAMPS, Flush Fitting

## DETAILED SPARE PARTS

Part No. . . . .	58655A/B F700	58656A F700 C.P.R.	58657A/B F700 C.P.R.	58669A F700 C.P.R.	58734A F700 C.P.R.	58772A F700 C.P.R.
Model . . . . .	—	—	—	—	—	—
Finish . . . . .	—	—	—	—	—	—
Replaced by (see footnote) . . . . .	—	—	—	—	—	—
§ Rim or door . . . . .	54520411	556275	555457	554903	54520158	54520122
§ Screw, rim fixing . . . . .	198898	198898	198898	552796	198913	54127511
Washer, screw retaining . . . . .	161385	161385	161385	—	161385	161385
Motif, top front or embellisher . . . . .	—	—	—	554905	—	—
Screw, embellisher, bracket and motif fixing . . . . .	—	—	—	116003	—	—
Bracket, rim fixing . . . . .	555704	555704	555704	552691	555940	—
§ Nut, rim fixing screw . . . . .	187117	187117	187117	—	187117	—
§ Excluder, dust . . . . .	552906	552906	552906	—	—	—
§ Plate, light unit retaining . . . . .	554872	554872	554872	554179	54520549	54520549
Screw, unit rim . . . . .	186137	186137	186137	186134	186137	186137
Rim, unit seating . . . . .	554871	554871	554871	554175	54520446	54520446
§ Light unit . . . . .	54520148	54520148	54520148	—	—	—
Spring, light unit fixing . . . . .	—	—	—	‡554180	54520514	54520514
Screw, plate fixing . . . . .	—	—	—	—	—	—
Spring, bulb retaining . . . . .	556442	556442	556442	—	—	—
§ Bulb holder or adaptor . . . . .	553738	553738	553738	553738	553738	553738
§ Sleeve, terminal . . . . .	555910	555910	555910	—	—	—
§ Backshell . . . . .	—	—	—	—	—	—
§ Bulb, main . . . . .	410	410	410	—	—	—
§ Gasket, rubber . . . . .	555458	555458	555458	54520607	54520512	54520508
Screw, with washer . . . . .	554288	554288	554288	554182	—	—
Spring, trimmer . . . . .	552813	552813	552813	‡‡554202	—	—
Washer, spring . . . . .	—	—	—	—	—	—
Screw, trimmer . . . . .	—	—	—	—	54520451	54520451
Nut, trimmer screw . . . . .	—	—	—	—	54520551	54520551
Housing, trimmer screw nut . . . . .	—	—	—	—	54520550	54520550
Bracket, rim securing . . . . .	—	—	—	54520598	—	—
Sleeve, sealing . . . . .	554626	554626	554626	—	—	—
§ Plate, adaptor . . . . .	—	—	—	54520599	—	—

Part No. . . . .	58773A F700 C.P.R.	58776A F700 C.P.R.	056991 F700GS	057458 F700	54052111 F700
Model . . . . .	—	—	—	—	—
Finish . . . . .	—	—	—	—	—
Replaced by (see footnote) . . . . .	—	—	—	—	—
§ Rim or door . . . . .	554439	54520673	554586	—	—
§ Screw, rim fixing . . . . .	198898	198898	129434	—	—
Washer, screw retaining . . . . .	161385	161385	188316	—	—
Motif, top front or embellisher . . . . .	—	—	¶554345	—	—
Screw, embellisher, bracket and motif fixing . . . . .	—	—	—	—	—
Bracket, rim fixing . . . . .	555704	555704	§554454	—	—
§ Nut, rim fixing screw . . . . .	187117	187117	—	—	—
§ Excluder, dust . . . . .	—	—	—	552906	552906
§ Plate, light unit retaining . . . . .	54520549	54520549	554463	554872	554872
Screw, unit rim . . . . .	186137	186137	186137	186137	186137
Rim, unit seating . . . . .	54520446	54520446	554871	554871	554871
§ Light unit . . . . .	—	—	554430	553921	553921
Spring, light unit fixing . . . . .	54520514	54520514	—	—	—
Screw, plate fixing . . . . .	—	—	—	—	—
Spring, bulb retaining . . . . .	—	—	—	—	—
§ Bulb holder or adaptor . . . . .	553738	553738	860629	554602	554602
§ Sleeve, terminal . . . . .	—	—	188818	555910	555910
§ Backshell . . . . .	—	—	**554350	—	—
§ Bulb, main . . . . .	—	—	367	414	414
§ Gasket, rubber . . . . .	54520505	54520919	554279	554279	554279
Screw, with washer . . . . .	—	—	554860	554288	554288
Screw, trimmer . . . . .	54520451	54520451	—	—	—
Spring, trimmer . . . . .	—	—	552813	552813	552813
Washer, spring . . . . .	—	—	—	—	—
Screw, body fixing . . . . .	—	—	—	—	—
Nut, trimmer screw . . . . .	54520551	54520551	—	—	—
Housing, trimmer screw nut . . . . .	54520550	54520550	—	—	—
Sleeve, sealing . . . . .	—	—	554626	554626	554626
§ Plate, adaptor . . . . .	—	—	††199004	—	—
Washer, cable grip . . . . .	—	—	553568	—	—

For illustrations, see pages G25-G29

Note. For replacement lamp spare parts, see appropriate column under part number ‡ Spring, unit securing rim seating § Recommended spares for stock  
 † Spring, trimmer screw retaining ¶ Rim, fixing § Clip, retaining rim \*\* Cover, bulb holder †† Grommet, cable entry C.P.R. . . Chromium plated rim

# HEADLAMP LENSES

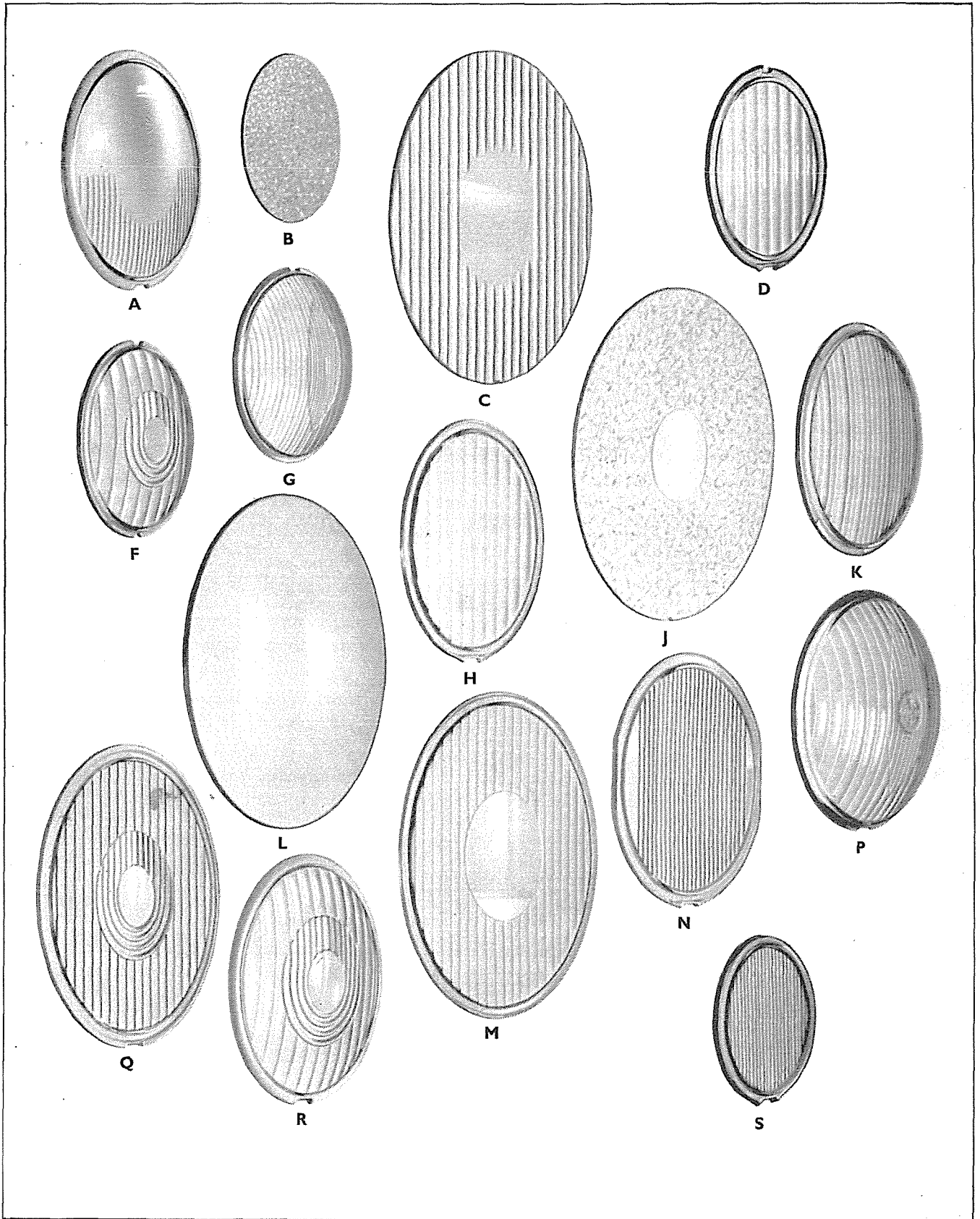

See page G70 for details



# HEADLAMP LENS CHART

Lens Diameter (overall)	Lens Part No.	Fitted to Models	Description	Illustration
5 $\frac{7}{16}$ "	552282	L-H-O .. .. .	Flat, fluted .. .. .	S
5 $\frac{1}{2}$ "	552307	L-H-O .. .. .	Flat, difusa .. .. .	B
6 $\frac{3}{8}$ "	503403	LBD133, MBD133 .. .. .	Domed, U-shaped flutes .. .. .	F
6 $\frac{1}{2}$ "	516144	L131, L133, M42, R35 .. .. .	Flat, difusa .. .. .	B
6 $\frac{1}{2}$ "	550875	MD133, MD134 .. .. .	Deep domed, diamond .. .. .	G
6 $\frac{3}{16}$ "	516199	L133 .. .. .	Flat, fluted .. .. .	D
7 $\frac{3}{16}$ "	509757	FF133 .. .. .	Oval, domed, fluted .. .. .	K
7 $\frac{7}{8}$ "	507586	LBD141, MBD140, MBD141, MBD143, MBD147, MBD148, MD140, MD141 .. .. .	Deep domed, diamond .. .. .	P
7 $\frac{7}{8}$ "	516173	L140, M140 .. .. .	Flat, difusa .. .. .	B
7 $\frac{13}{16}$ "	551308	LBD140, LD140, LBD147, LD147, LBD148S, MBD140, MD140, MBD148, MD143, MBD147, MBD148 .. .. .	Domed, U-shaped flutes .. .. .	R
7 $\frac{13}{16}$ "	551674	MG140 .. .. .	Flat, fluted .. .. .	H
7 $\frac{7}{8}$ "	504224	LBD147, MBD140, MBD147 .. .. .	Domed, lower half vertical flutes .. .. .	A
8 $\frac{1}{4}$ "	510770	LG150, M150 .. .. .	Flat, fluted .. .. .	N
8 $\frac{1}{2}$ "	505975	L150, M150, MB150 .. .. .	Flat, difusa .. .. .	B
8 $\frac{1}{2}$ "	551070	MBD150 .. .. .	Deep, domed, diamond .. .. .	G
8 $\frac{1}{2}$ "	551093	LBD150, MBD150 .. .. .	Domed, U-shaped flutes .. .. .	F
8 $\frac{3}{4}$ "	500371	P80 .. .. .	Flat, U-shaped flutes .. .. .	F
9 $\frac{1}{8}$ "	507163	LBD163, LBD165, LBD166, MBD166, QBD166S .. .. .	Domed, U-shaped flutes .. .. .	F
10 $\frac{1}{4}$ "	504384	QK596 .. .. .	Flat, U-shaped flutes .. .. .	Q
10 $\frac{11}{16}$ "	503778	P100 .. .. .	Flat, fluted, plain centre .. .. .	M
9 $\frac{1}{8}$ "	508724	LBD163, LBD165, LBD166, MBD166 .. .. .	Deep domed, diamond .. .. .	G
11 $\frac{1}{4}$ "	506411	R100 .. .. .	Flat, plain .. .. .	L
11 $\frac{1}{4}$ "	506508	R100 .. .. .	Flat, fluted, plain centre .. .. .	C
11 $\frac{1}{4}$ "	509689	P100 .. .. .	Flat, difusa, plain centre .. .. .	J

For illustrations, see page G69

# HEADLAMP CONVERSION SETS



## HEADLAMP CONVERSION SETS

These sets enable owners of older vehicles to bring their lighting equipment into line with the more exacting requirements of to-day.

The Lucas '700' light unit, incorporating the block pattern lens, provides improved light distribution, whilst the 'double dipping' system reduces dazzle to oncoming traffic, with an increased margin of safety.

Moreover, the safety factor is further enhanced by the use of the Lucas 'Beamsetter' for the correct alignment of light units. This is a considerable advance on earlier methods of headlamp adjustment employed with the separate reflector and lens.

Conversion sets consist of the following parts, assembled ready for fitting to existing lamp bodies.

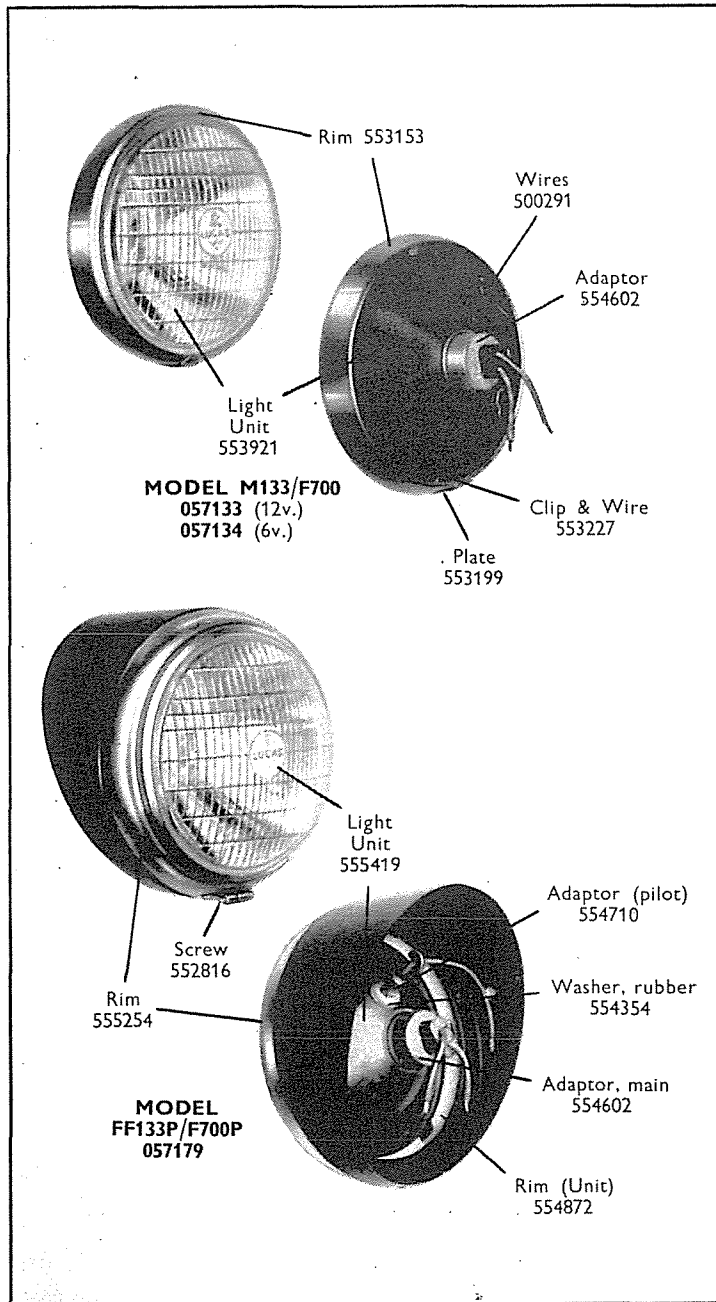

**M133/F700**

**12 volt Part No. 057133**

**6 volt Part No. 057134**

*Home and Export, dip left (right hand drive)*

Similar to M140/F700 sets, but suitable for converting all 133 type headlamps (6" aperture) to double dipping system, or single dip if required.

No. of	Description	Part No.
2	§Rim or door .. .. .	553153
2	§ Plate, rim clamping .. .. .	553199
2	§ Wire, rim plate .. .. .	553227
2	§Light unit .. .. .	553921
2	§Plate, rim fixing .. .. .	553199
8	§Wire, light unit fixing .. .. .	500291
2	§Adaptor .. .. .	554602
1	§Bung, rubber .. .. .	861393
2	Bracket, adaptor .. .. .	599936
2	§Bulb, 12 volt .. .. .	354
2	§Bulb, 6 volt .. .. .	373

**FF133P/F700P**

**6 volt Part No. 057179**

*Home and Export, dip left (right hand drive)*

Exclusively marketed for Morris 8 h.p. 1939-48 models.

Similar to F575P/F700P sets, but suitable for converting FF133P headlamps (6" aperture) to 7", incorporating pilot light.

No. of	Description	Part No.
2	§Rim or door .. .. .	555254
2	§ Screw, rim fixing .. .. .	552816
2	§Excluder, dust .. .. .	552906
2	§Plate, light unit retaining .. .. .	554872
6	Screw, unit rim fixing .. .. .	186137
2	Rim, unit seating .. .. .	554871
2	§Light unit .. .. .	555419
2	§Bulb holder, main .. .. .	554399
2	§ Sleeve, terminal .. .. .	555910
2	§Bulb, main .. .. .	373
2	§Bulb holder, pilot .. .. .	554710
2	§ Interior, pilot bulb holder .. .. .	553780
2	§ Ring, pilot bulb holder seating .. .. .	554354
2	§Bulb, pilot .. .. .	988
6	Screw, with washer, trimmer .. .. .	554288
6	Spring, trimmer .. .. .	552813
6	Sleeve, sealing .. .. .	554626
2	Piece, distance (body) .. .. .	555242



# HEADLAMP CONVERSION SETS

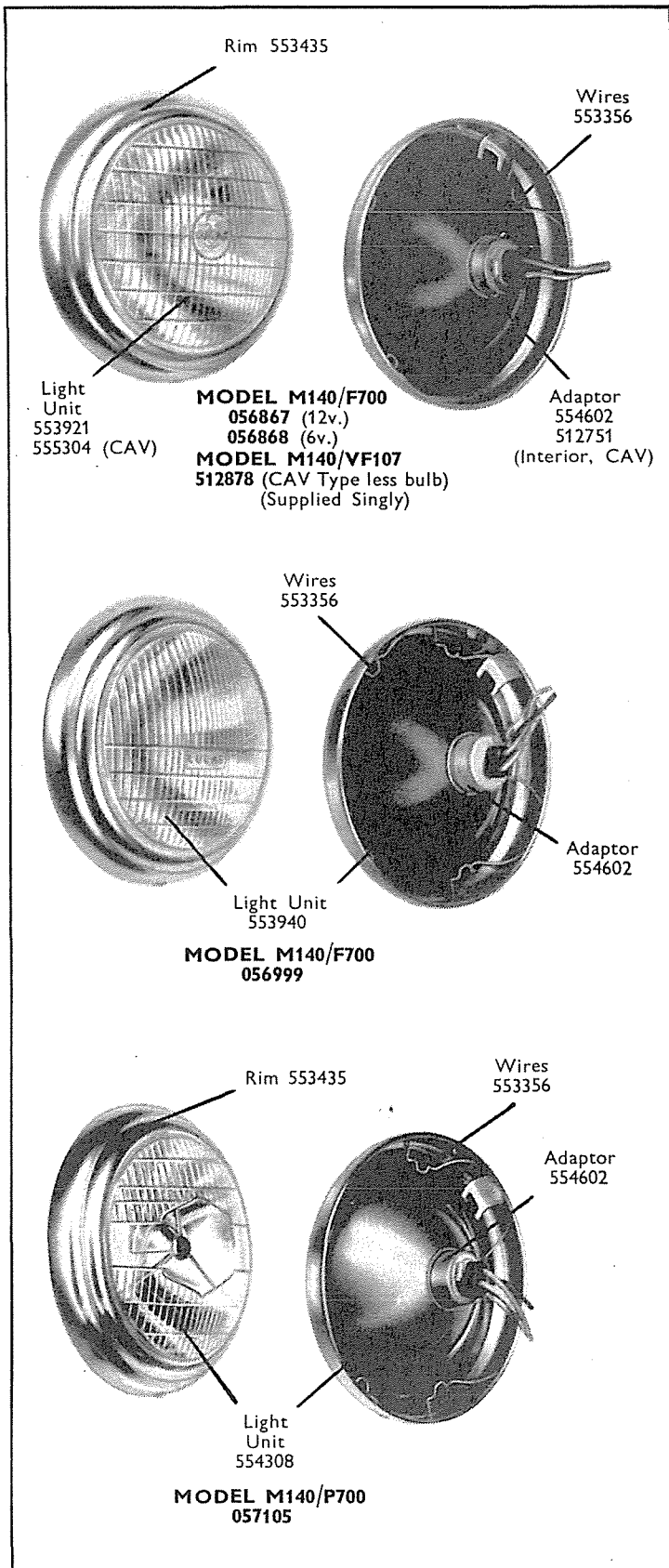

**M140/F700** 12 volt Part No. 056867  
6 volt Part No. 056868

*Home and Export, dip left (right hand drive)*

For converting M140 headlamps with separate lens and reflector to F700 light units. (See also De Luxe Model M140/P700).

No. off	Description	Part No.
2	§Rim or door .. .. .	553435
10	§Wire, light unit fixing .. .. .	553356
2	§Light unit .. .. .	553921
2	§Adaptor .. .. .	554602
2	§Bulb, 12 volt .. .. .	354
2	§Bulb, 6 volt .. .. .	356

**M140/F700** 12 volt Part No. 056999

*Export Europe, not France, vertical dip*

Similar to 056867, but suitable for European countries other than France.

No. off	Description	Part No.
2	§Rim or door .. .. .	553435
10	§Wire, light unit fixing .. .. .	553356
2	§Light unit .. .. .	553940
2	§Adaptor .. .. .	554602
2	§Bulb .. .. .	370

**M140/P700** 12 volt Part No. 057105

*Home and Export, dip left (right hand drive)*

Similar to M140/F700 sets, but with De Luxe type light units. The chromium plated tripod and bulb shield, together with the attractive lens pattern, combine to give a longer centre driving beam.

No. off	Description	Part No.
2	§Rim or door .. .. .	553435
10	§Wire, light unit fixing .. .. .	553356
2	§Light unit .. .. .	554308
2	§Adaptor .. .. .	554602
2	§Bulb .. .. .	354

**M140/VF107** Less bulb Part No. 512878

*British Road Services, dip left*

For converting C.A.V. M140 headlamps with separate lens and reflector to VF107 light units.

No. off	Description	Part No.
1	§Rim or door .. .. .	553435
5	§Wire, light unit fixing .. .. .	553356
1	§Light unit, with bulb holder .. .. .	555304
1	§ Interior, bulb holder .. .. .	512751
1	§ Sleeve, terminal .. .. .	188818
3	§ Screw, terminal .. .. .	126444
3	Washer, spring, terminal screw .. .. .	185040
1	§ Sleeve, bulb .. .. .	512811

§ Recommended spares for stock



# HEADLAMP CONVERSION SETS

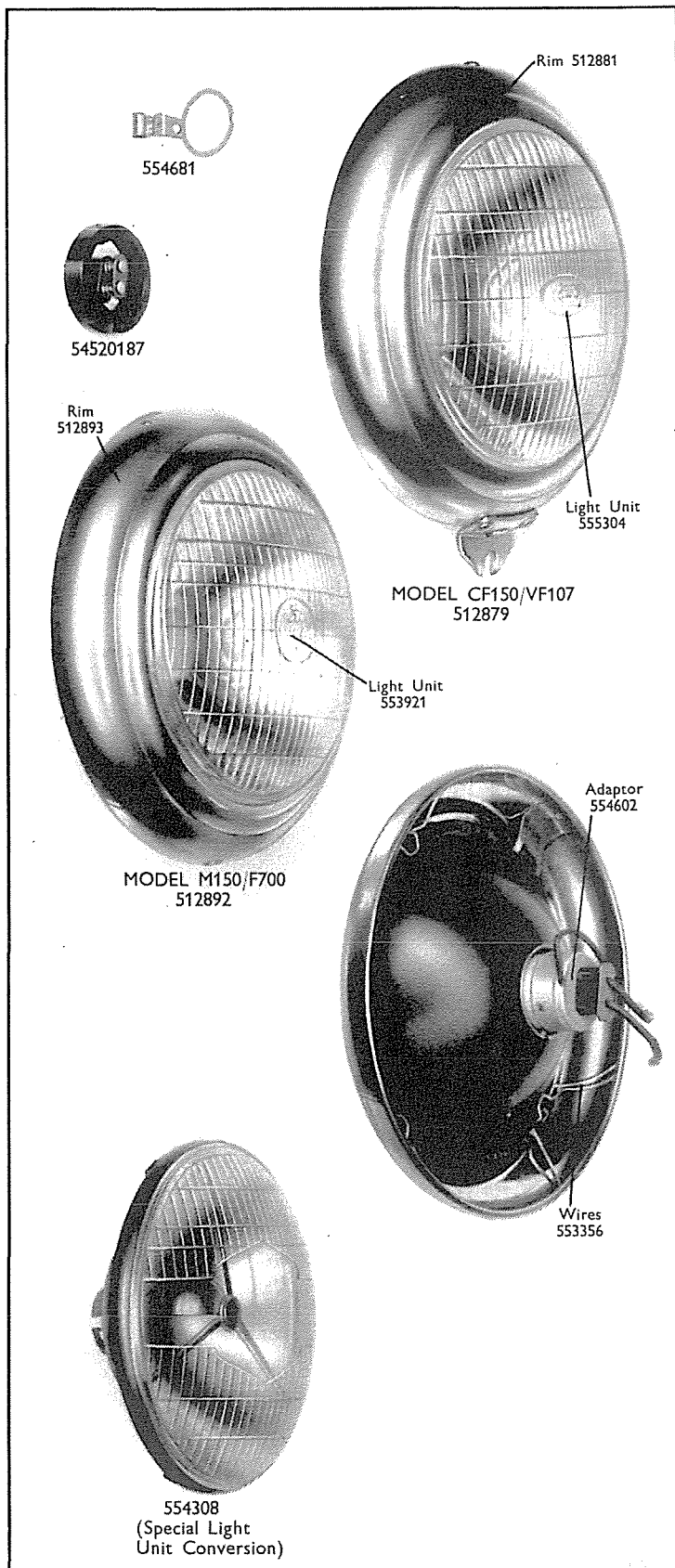

## CF150/VF107

Part No. 512879

*British Road Services, dip left*

For converting C.A.V. CF150 headlamps with separate lens and reflector to VF107 light units.

No. off	Description	Part No.
1	§Light unit .. .. .	555304
1	§Terminal, earth .. .. .	554681
1	§Adaptor .. .. .	54520187
1	§Rim .. .. .	512881
5	§Wire, light unit fixing .. .. .	553356

## M150/F700

12 volt Part No. 512892

*Home and Export, dip left (right hand drive)*

Specially designed chromium plated rim houses the light unit with block pattern lens, and is quickly fitted to all 150 type headlamps.

No. off	Description	Part No.
2	§Rim or door .. .. .	512893
10	§Wire, light unit fixing .. .. .	553356
2	§Light unit .. .. .	553921
2	§Adaptor .. .. .	554602
2	§Bulb .. .. .	354

## F700/P700

12 volt Part No. 554308

*Home and Export, dip left (right hand drive)*

A special unit designed to permit replacement of the standard F700 light unit by the De Luxe P700.

No. off	Description	Part No.
1	§Light unit .. .. .	554308

## RF770/RL700

12 volt Part No. 54052120

*Home and Export, dip left (right hand drive)*

A special set designed to convert RF770 reflector type lamps on Rolls-Royce to RL700 light unit type.

No. off	Description	Part No.
2	§Plate, unit retaining .. .. .	553971
2	§Rim, unit seating .. .. .	553972
8	§Screw, fixing .. .. .	186137
2	§Light unit .. .. .	54520275
2	§Adaptor .. .. .	553738
2	§Bulb .. .. .	416



# HEADLAMP CONVERSION SETS

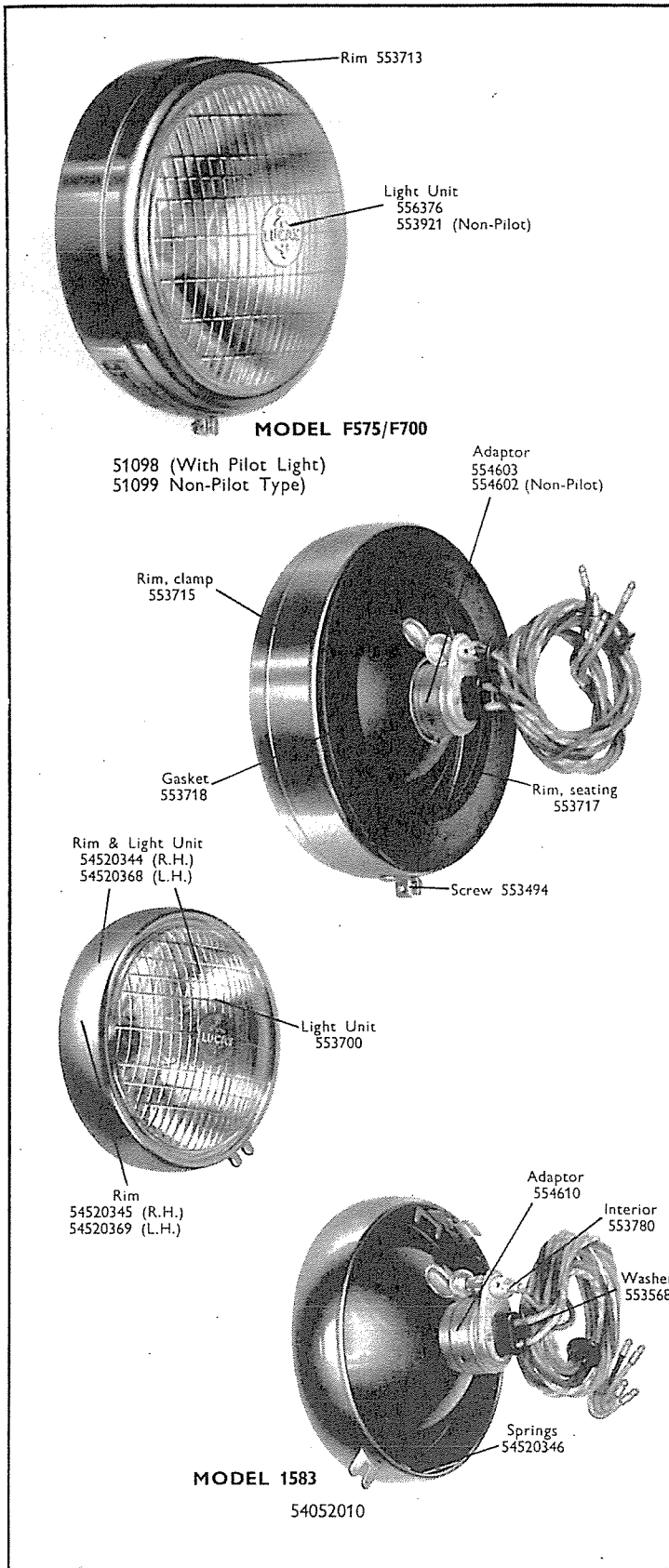

## F575P/F700P

12 volt Part No. 51098A

*Home and Export, dip left (right hand drive)*

For converting 5 $\frac{3}{4}$ " light aperture to 7" with Lucas block pattern lens light units. Incorporates pilot light.

No. off	Description	Part No.
2	§Rim or door .. ..	553713
10	§Wire, light unit fixing .. ..	500291
2	§Light unit .. ..	556376
1	§Adaptor .. ..	554603
1	§Bulb, main .. ..	354
1	§Bulb, pilot .. ..	222
2	Rim, unit seating .. ..	553717
6	Bracket, adjuster .. ..	553721
6	Screw, bracket fixing .. ..	126463
2	§Gasket, clamp rim seating .. ..	553718
2	§Rim, clamp .. ..	553715
2	§Screw, clamp rim fixing .. ..	553494

## F575/F700

12 volt Part No. 51099A

*Home and Export, dip left (right hand drive)*

Similar to 51098A, but less pilot light.

No. off	Description	Part No.
2	§Rim or door .. ..	553713
10	§Wire, light unit fixing .. ..	500291
2	§Light unit .. ..	553921
1	§Adaptor .. ..	554602
1	§Bulb, main .. ..	354
2	Rim, unit seating .. ..	553717
6	Bracket, adjuster .. ..	553721
6	Screw, bracket fixing .. ..	126463
2	§Gasket, clamp rim seating .. ..	553718
2	§Rim, clamp .. ..	553715
2	§Screw, clamp rim fixing .. ..	553494

## 1583

6 volt Part No. 54052010

*Home and Export, dip left (right hand drive)*

A special set designed to convert Ford Popular lamps with separate reflector and lens to the modern light unit type with chromium plated rims.

No. off	Description	Part No.
1	§Rim or door (R.H.) .. ..	54520344
1	§Rim .. ..	54520345
4	§Springs .. ..	54520346
1	Light unit .. ..	553700
1	§Rim or door (L.H.) .. ..	54520368
1	§Rim .. ..	54520369
4	§Springs .. ..	54520346
1	Light unit .. ..	553700
2	§Bulb holder .. ..	554610
2	§Interior .. ..	553780
2	§Sleeve .. ..	188818
2	§Washer, cable grip .. ..	553568
2	§Bulb, main .. ..	373
2	§Bulb, pilot .. ..	988

# HEADLAMPS

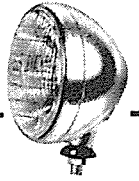

## VEHICLE APPLICATION REFERENCE

- 50082 MBD133 (R.H.). 6v.; single contact; C.P. finish; 24° fixing. Standard 8 1946.
- 50083 MBD133-EDS (L.H.). 6v.; single contact; C.P. finish; 24° fixing. Standard 8 1946.
- 50087 MBD134-1EDS (L.H.). 12v.; single contact; C.P. finish; 90° fixing. Wolseley 10 1946-48.
- 50124 L-H1-O. 12v.; double contact; E.B. finish; upright fixing. Commer 25 cwt. Forward Control 1947-51. Karrier 'Bantam' (late) 1946-50. Midland Vehicles 1951-55. Morrison Electricars Battery Vehicle 1951-54; BM, D1, F and FL 1955-60. Rover 'Landrover' Station Wagon 1948-50. Standard 12 1946.
- 50129 L-H2-O. 12v.; single contact; E.B. finish; upright fixing. Commer 8 cwt. Van and 25 cwt. Forward Control 1946. Karrier 'Bantam' 1946. Larmar Engineering Invalid Carriage 1948-54. Morris 10 cwt. Van 1946. Morris Commercial 25/35 cwt. 1946.
- 50146 MBD133-1EDS (L.H.). 6v.; single contact; C.P. finish; 90° fixing. Austin 8 Saloon and Tourer 1946-47. Wolseley 8 1946-48.
- 50147 MBD133-1 (R.H.). 6v.; single contact; C.P. finish; 90° fixing. Austin 8 Saloon and Tourer 1946-47.
- 50148 MBD133-1 (L.H.). 6v.; double contact; C.P. finish; 90° fixing. Austin 8 Saloon and Tourer 1946-47. Wolseley 8 1946-48.
- 50150 MBD166S-EDS (L.H.). 12v.; single contact; C.P. finish; upright fixing. Alvis 14 1946. Jaguar 1½ litre 1946-47.
- 50151 MBD166S (R.H.). 12v.; single contact; C.P. finish; upright fixing. Alvis 14 1946. Jaguar 1½ litre 1946-47.
- 50163 P100LS-EDS (L.H.). 12v.; single contact; C.P. finish; upright fixing. Jaguar 2½ and 3½ litre 1946-48.
- 50164 P100LS (R.H.). 12v.; single contact; C.P. finish; upright fixing. Jaguar 2½ and 3½ litre 1946-48.
- 50170 MBD133 (R.H.). 6v.; single contact; C.P. finish; 25° fixing; sliding bolt. Standard 8 1947-48.
- 50171 MBD133-EDS (L.H.). 6v.; single contact; C.P. finish; 25° fixing; sliding bolt. Standard 8 1947-48.
- 50176 MBD147-EDS (L.H.). 12v.; single contact; C.P. finish; upright fixing. Humber 'Hawk' 1946-48.
- 50177 MBD147 (R.H.). 12v.; single contact; C.P. finish; upright fixing. Humber 'Hawk' 1946-48.
- 50185 MU42. 6v.; double contact; E.B. and C.P.R. finish; side bolt fixing. Barrett Invalid Carriage 1949-50.
- 50199 MD134-1EDS (L.H.). 6v.; single contact; E.B. and C.P.R. finish; 90° fixing. Bedford 5/6 cwt. Van 1946-47; 10/12 cwt. Van 1946-51. Vauxhall 10 1946-47; 12 1947.
- 50200 MD134-1. 6v.; single contact; E.B., C.P.R. finish; 90° fixing. Bedford 5/6 cwt. Van 1946-47; 10/12 cwt. Van 1946-52. Vauxhall 10 1946-47; 12 1947.
- 50203 MBD166-1S. 12v.; single contact; C.P. finish; upright fixing; inverted ball shell. Humber 'Imperial' and 'Pullman' 1946-47; 'Snipe' and 'Super Snipe' 1946.
- 50219 MD134-1 (L.H., Export). 6v. or 12v.; Double contact; E.B., C.P.R. finish; 90° fixing. Bedford 10/12 cwt. Van 1950-52. Vauxhall 10 and 12 1947. Wolseley 10 1948.
- 50220 MD134-1 (R.H., Export). 6v. and 12v.; double contact; E.B., C.P.R. finish; 90° fixing. Bedford 10/12 cwt. Van 1950-52. Vauxhall 10 and 12 1947. Wolseley 10 1948.
- 50260 MD133-1EDS (L.H.). 12v.; single contact; E.B. finish; 90° fixing. Austin 10 Van 1946-47.
- 50267 MBD133-2 (L.H., Export). 6v.; double contact; C.P. finish; 25° fixing; sliding bolt. Standard 8 1946-48.
- 50268 MBD133-2 (R.H., Export). 6v.; double contact; C.P. finish; 25° fixing; sliding bolt. Standard 8 1946-48.
- 50273 MBD166-1S (Export). 12v.; double contact; C.P. finish; upright fixing; inverted ball shell. Humber 'Super Snipe' 1946.
- 50301 MBD143 (R.H., Export). 12v.; double contact; C.P. finish; 90° fixing. Austin 10 1946-47.
- 50307 P100LS-EDS (Export, vertical dip). 12v.; single contact; C.P. finish; upright fixing. Jaguar 2½ and 3½ litre 1947-48.
- 50319 M133P (R.H.). 12v.; single contact, main and pilot; E.B. finish; upright fixing. Jowett 'Bradford' Van 1946-52; De Luxe Van and 6 Light Utility 1949-50. Trojan 15/20 cwt. Van 1946-53.
- 50329 R100S (R.H.). 12v.; single contact; C.P. finish; upright fixing. Rolls-Royce 'Silver Wraith' 1946-55.
- 50349 MBD166S (L.H. or R.H., Export). 12v.; double contact; upright fixing. Lea Francis 14 1950.
- 50364 M133P (L.H.). 12v.; double contact main, single contact pilot; E.B. finish; upright fixing. Austin 8 Van 1946-47. Jowett 'Bradford' Van 1946. Reliant 700 c.c. 3-wheeler 1949-52. Trojan 15/20 cwt. Van 1946-50.
- 50406 MD133. 6v.; double contact; E.B. finish; upright fixing. Jensen 'Jen-Tug' 1946-52.
- 50413 MBD133-3EDS (L.H.). 12v.; single contact; E.B. finish; upright fixing; sliding bolt. Morris 10 cwt. Van 1950.
- 50414 MBD133P (L.H.). 6v.; double contact main, single contact pilot; C.P. finish; 24° fixing. Morgan 3-wheeler 1948-52.
- 50415 MBD133P (R.H.). 6v.; double contact main, single contact pilot; C.P. finish; 24° fixing. Morgan 3-wheeler 1948-52.
- 50428 R100S (L.H. or R.H.). 12v.; single contact; C.P. finish. Rolls-Royce 'Silver Wraith' 1946-55.
- 50434 MD148P (R.H.). 12v.; single contact; E.B., C.P.R. finish; upright fixing. Morris Commercial 15/20 cwt. (PV) 1948-49.
- 50440 MD140-EDS (L.H.). 12v.; single contact; E.B. finish; 90° fixing. Morris Commercial 25/30 cwt. (LC3) 1946-49; 35/40, 45/55 and 60/70 cwt., 5 ton Forward Control, Tipper and ECV13/3 1946-48; CV Ambulance 1947-49; CVF13/5 1946-47; CV11/30, CV11/40 and CV10 1946-48.
- 50441 MD140 (R.H.). 12v.; single contact; E.B., C.P.R. finish; 90° fixing. Morris Commercial 25/30 cwt. (LC3) 1946-49; 35/40, 45/55 and 60/70 cwt., 5 ton Forward Control, Tipper and ECV13/3 1946-48; CV Ambulance 1947-49.
- 50472 MBD148-EDS (L.H.). 12v.; single contact; C.P. finish; upright fixing. M.G. 'Midget' 1948. Wolseley 12 1946-48.
- 50473 MBD148 (R.H.). 12v.; single contact; C.P. finish; upright fixing. Lanchester 10 1946-51; 14 1952. M.G. 'Midget' 1948. Wolseley 12 1946-48.
- 50476 MBD148 (Export). 12v.; double contact; C.P. finish; upright fixing. Wolseley 12 1948.
- 50489 P100L (Export). 12v.; double contact; C.P. finish; upright fixing. Jaguar 2½ and 3½ litre 1947-48.
- 50500 MBD147-EDS (L.H.). 12v.; single contact; C.P. finish; 90° fixing. Sunbeam-Talbot 2 litre 1946-47.
- 50502 P100LS-EDS (Export). 12v.; single contact; C.P. finish; upright fixing. Austin A125 1948-54; DA1 and DH1 1951-55.
- 50507 MBD147-4 (L.H., Export). 12v.; double contact; 90° fixing. Sunbeam-Talbot 1946-47.
- 50511 MD140-1EDS (L.H.). 12v.; single contact; E.B., C.P.R. finish; upright fixing. Commer 8 cwt. Van 1947; 12/25 cwt. 1946-48; 25 cwt. 'Lyons' Van 1949-50; 25 cwt. 'Super-poise' Van 1949; 2 and 3 ton 1946; 3 and 4 ton Trucks, Pantechinon and Tipper 1947-49; 5 ton 1947. Hillman 'Minx' All Models 1946-47. Morris 10 1946-48; 'Oxford' Taxi and Hire Car 1947-50.
- 50512 MD140-1 (R.H.). 12v.; single contact; E.B., C.P.R. finish; upright fixing. Commer 8 cwt. Van 1947; 12/25 cwt. 1946-48; 25 cwt. 'Lyons' Van 1949-50; 25 cwt. 'Super-poise' Van 1949; 2 and 3 ton 1946-47; 5 ton 1947. Hillman 'Minx' All Models 1946-47. Morris 10 1946-48; 'Oxford' Taxi and Hire Car 1947-50.
- 50519 MD140-1 (Export). 12v.; double contact; E.B., C.P.R. finish; upright fixing. Hillman 'Minx' 1947.
- 50523 MBD140-1 (Export). 12v.; double contact; C.P. finish; upright fixing. Citroen 15 and 23 1951-52. Commer 'Commando' 1947-49; 5 ton 1947. H.R.G. 9 and 12 (Sports) 1946-50. M.G. 1½ litre Saloon 1949-50; 'Midget' 1949. Morgan 'Plus Four' 1946-50; 'Four Four' 1949-50. Singer 9 and 10 1947-49.
- 50529 F575P-1 (dip left). 12v.; double contact main, single contact pilot; C.P.R. finish; upright fixing. Morris 'Minor' 1948-50; 'Minor' 2-door 1951.
- A50529 F575P-1 (dip right, Export). As 50529 except for bulb. Morris 'Minor' 1948-50; 'Minor' 2-door 1951.
- B50529 F575P-1 (vertical dip, Export Europe, not France). As 50529 except for bulb. Morris 'Minor' 1948-50; 'Minor' 2-door 1951.
- 50530 MD166S-2 (L.H.). 12v.; single contact; C.P. finish; 90° fixing. Daimler 2½ litre (except 'Consort') 1946-49.
- 50531 MBD166S-2 (R.H.). 12v.; single contact; C.P. finish; 90° fixing. Daimler 2½ litre (except 'Consort') 1946-49.
- 50532 P100LS-EDS (L.H.). 12v.; single contact; C.P. finish; upright fixing. Austin A125 1948-54; DA1 and DH1 1952-55.
- 50533 P100LS (R.H.). 12v.; single contact; C.P. finish; upright fixing. Austin A125 1948-54; DA1 and DH1 1952-55. Daimler 27 and 36 1946-53.
- 50541 MBD163-1 (R.H.). 12v.; single contact; C.P. finish; 25° fixing; sliding bolt. Triumph '1800' 1946-48; '2000' 1949.
- 50542 MBD163-1 (L.H., Export). 12v.; double contact; C.P. finish; 25° fixing; sliding bolt. Triumph '1800' 1947-48; '2000' 1949.
- 50543 MBD163-1 (R.H., Export). 12v.; double contact; C.P. finish; 25° fixing; sliding bolt. Triumph '1800' 1947-48; '2000' 1949.
- 50565 MBD141 (L.H., Export). 12v.; double contact; C.P. finish; 90° fixing. Austin 12 1946-47; 16 1946.
- 50569 MD133P (L.H. or R.H.). 12v.; double contact main, single contact pilot; E.B. finish; upright fixing. Jowett 'Bradford' Van 1946-52; De Luxe Van and 6 Light Utility 1949-50. Reliant 750 c.c. 3-wheeler (Export) 1950.
- 50572 F575 (dip left). 12v.; double contact; C.P.R. A.C. Cars Invalid Carriage 1950-51. Austin 25 cwt. Van and Ambulance 1948-54. Commer 8 cwt. Van 1950. Hillman 'Minx' 1949.
- A50572 F575 (dip right, Export). As 50572 except for bulb. Austin 25 cwt. Van and Ambulance 1948-54.
- B50572 F575 (vertical dip, Export Europe, not France). As 50572 except for bulb. Austin 25 cwt. Van and Ambulance 1948-54.
- 50600 MBD166S-EDS (L.H.). 12v.; single contact; C.P. finish; upright fixing. Citroen 23 1949-50. Lea Francis 14 1946-50.
- 50601 MBD166S (R.H.). 12v.; single contact; C.P. finish; upright fixing. Citroen 23 1949-50. Lea Francis 14 1946-50.
- 50603 MD143 (R.H., Export). 12v.; double contact; E.B. finish; 90° fixing. Austin Coach 1947-49; 2/5 ton Petrol Tanker 1948.
- 50605 F700P (dip right, Export). 12v.; double contact; C.P.R. Aston Martin 2 litre 1948-50. Humber 'Imperial' and 'Pullman' 1948. Standard 'Vanguard' 1948-49. Wolseley 'Four Fifty' 1949-51.
- 50606 MD140 (L.H.). 12v.; double contact; E.B. finish; 90° fixing. Dodge Petrol Models 1949. Morris Commercial 25/30 cwt. (LC3) 1946-49; 35/40, 45/55 and 60/70 cwt., 5 ton Forward Control, Tipper and ECV13/3 1946-48; ECV13/5 and ECV013/5 1949.

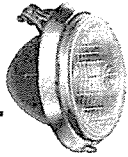

# HEADLAMPS

## VEHICLE APPLICATION REFERENCE—continued

- 50607 MD140 (R.H.). 12v.; double contact; E.B. finish; 90° fixing.  
Morris Commercial 25/30 cwt. (LC3) 1946-49; 35/40, 45/55 and 60/70 cwt., 5 ton Forward Control, Tipper and ECV13/3 1946-48; ECV13/5 and ECV013/5 1949.
- 50613 F575P (dip left). 12v.; double contact; C.P.R.; with pilot light.  
A.C. Cars Invalid Carriage 1947-49.  
Austin A40 1948-49; A40 Van, 'Countryman' and Pick-up Truck 1948.  
Commer 8 cwt. Van 1948-49.  
Hillman 'Minx' All Models 1948; 'Magnificent' 1948-49.  
Jowett 'Javelin' De Luxe 1948-50.  
Vauxhall All Models 1948-49.
- A50613 F575P (dip right, Export). As 50613 except for bulb.  
Austin A40 Van, 'Countryman' and Pick-up Truck 1948.  
Jowett 'Javelin' De Luxe 1948-50.  
Vauxhall All Models 1948-49.
- B50613 F575P (Export Europe, not France). As 50613 except for bulb.  
Austin A40 Van, 'Countryman' and Pick-up Truck 1948.  
Jowett 'Javelin' and De Luxe 1948-50.  
Vauxhall All Models 1948-49.
- 50628 P100LS (Export). 12v.; double contact; C.P. finish; upright fixing.  
Daimler 27 and 36 1946-53.
- 50645 MBD133P (L.H.). 12v.; double contact main, single contact pilot; E.B., C.P.R. finish; upright fixing.  
Jowett 'Bradford' Van (alternative) 1947-52; De Luxe Van and 6 Light Utility 1951-52.  
Lloyd '650' 1948-50.
- 50646 MBD133P (R.H.). 12v.; single contact main, and pilot; E.B., C.P.R. finish; upright fixing.  
Jowett 'Bradford' Van (alternative) 1947-52; De Luxe Van and 6 Light Utility 1951-52.  
Lloyd '650' 1948-50.
- 50649 MD133P-3. 6v. or 12v.; double contact main, single contact pilot; E.B. finish; upright fixing; sliding bolt.  
Morris 5 cwt. Van 1946-53; 10 cwt. Van 1947-50.
- 50654 MBD148 (Export). 12v.; double contact; C.P. finish; upright fixing.  
Lanchester 10 1948-51; 14 1952-53.
- 50655 MBD166S (L.H., Export). 12v.; double contact; C.P. finish; 90° fixing.  
Daimler 2½ litre (except 'Consort') 1948-49.
- 50656 MBD166S (R.H., Export). 12v.; double contact; C.P. finish; 90° fixing.  
Daimler 2½ litre (except 'Consort') 1948-49.
- 50659 MD133-1 (R.H.). 6v.; single contact; E.B., C.P.R. finish; 90° fixing.  
Austin 10 Van 1946-47.  
Jowett De Luxe Van and 6 Light Utility 1949-50.
- 50664 F575P-EF (Export). Double contact; C.P.R.; less bulb.  
Commer 8 cwt. Van 1948-49.  
Hillman 'Minx' 1948-49.
- 50675 F700P-EF (vertical dip, Export). 12v.; double contact; C.P.R.; with motif; to take 3-pin bulb.  
Sunbeam-Talbot '90' 1948-49.
- 50679 F700P-EF (Export). As 50675 except for rim.  
Morris 'Cowley' Van and Pick-up Truck 1950-51; 'Oxford' and 'Six' 1948-51.  
Wolseley 'Four Fifty' 1949-51.
- 50693 R100S-EF (Export). Double contact; C.P. finish; upright fixing; less bulb.  
Rolls-Royce 'Silver Wraith' 1947-55.
- 50707 MBD143-EDS (L.H.). 12v.; single contact; C.P. finish; 90° fixing.  
Austin 10 1946-47; Hire Car 1950-52.  
Dodge Petrol Models 1949.
- 50709 MBD143 (L.H., Export). 12v.; double contact; C.P. finish; 90° fixing.  
Austin 10 1946-47; Hire Car 1951-54.
- 50711 MD143-EDS (L.H.). 12v.; single contact; E.B., C.P.R. finish; 90° fixing.  
Austin 10 1946; Taxi 1948-54; Hire Car 1952-54; 2 and 5 ton Trucks 1949-50; Coach 1947-49.
- 50712 MD143 (R.H.). 12v.; single contact; E.B., C.P.R. finish; 90° fixing.  
Austin 10 1946; Taxi 1948-54; Hire Car 1952-54; 2 and 5 ton Trucks 1949-50; Coach 1947-49.
- 50714 MD143 (R.H.). 12v.; double contact; E.B., C.P.R. finish; 90° fixing.  
Austin 2/5 ton Petrol Tanker 1946-47.
- A50723 F700 (dip right, Export). 12v.; double contact; C.P.R.  
Riley 1½ litre 1949; 2½ litre 1948-49.
- B50723 F700 (vertical dip, Export). 12v.; double contact; C.P.R.  
Riley 1½ and 2½ litre 1949.
- 50730 L-H-O. 12v.; double contact; E.B. finish; no fixing bolt.  
Hindle Smart 1951-54.
- 50731 R100S-EDS (L.H.). 12v.; single contact; C.P. finish; upright fixing.  
Rolls-Royce 'Silver Wraith' 1946-55.
- 50746 MD133P-3. 6v. or 12v.; single contact main and pilot; E.B. finish; upright fixing; sliding bolt.  
Morris 5 cwt. Van 1948-53. 10 cwt. Van 1947-50.
- 50747 F700EF (vertical dip, Export). 12v.; double contact; C.P.R.  
Riley 1½ litre 1949-50; 2½ litre 1948-50.
- 50751 RF770 (dip left). 12v.; double contact; C.P.R.  
Austin A135 1948.  
Bentley 4½ litre 1946-51.
- 50752 MBD140-EDS (L.H.). 12v.; single contact; C.P. finish; upright fixing.  
Citroen 15 1946-50.  
Commer 'Commando' (Petrol) 1947-49; 5 ton 1947.  
M.G. 'Midget' 1946-47.  
Singer 9, 10 and 12 1946-49.
- 50753 MBD140 (R.H.). 12v.; single contact; C.P. finish; upright fixing.  
Citroen 15 1946-50.  
Commer 'Commando' (Petrol) 1947-59; 5 ton 1947.  
H.R.G. 9 and 12 (Sports) 1946-50.  
M.G. 1½ litre Saloon 1949-50; 'Midget' 1946-47 and 1949.  
Morgan 'Plus Four' 1946-50; 'Four Four' 1949-50.  
Singer 9, 10 and 12 1946-49.
- 50757 F700P-EF (Export). Single contact pilot; C.P.R.; less main bulb.  
Armstrong Siddeley 'Hurricane', 'Lancaster' and 'Typhoon' 1948-50; 'Whitley' 1950.
- 50773 P100 (Export U.S.A.). 12v.; double contact; C.P. finish; upright fixing.  
Austin A125 1948-54; DA1 and DH1 1951-55.
- 50778 PF770 (dip left). 12v.; double contact; C.P.R.  
Jaguar 2½ and 3½ litre 1949-51; XK120 1951-54.
- A50778 PF770 (dip right, Export). As 50778 except for bulb.  
Jaguar 2½ and 3½ litre 1949-51; XK120 1951-54.
- B50778 PF770 (vertical dip, Export Europe, not France). As 50778 except for bulb.  
Jaguar 2½ and 3½ litre 1949-51; XK120 1951-54.
- 50781 PF770 (Export). C.P.R.; less light unit and bulb.  
Daimler 2½ litre 1951-53.  
Jaguar 2½ and 3½ litre 1949-51; XK120 1951-54.
- A50793 F700P (dip right, Export). 12v.; double contact; C.P.R.; with pilot light.  
Humber 'Hawk' and 'Super Snipe' 1949.  
Morris 'Cowley' Van and Pick-up Truck 1950-51; 'Oxford' and 'Six' 1948-51.  
Singer 'SM1500' 1949.
- 50794 F700P (dip left, Export). Double contact; C.P.R.  
Sunbeam-Talbot 2 litre 1947; '80' and '90' 1948-50.
- A50794 F700P (dip right, Export). As 50794 except for bulb.  
Sunbeam-Talbot '90' 1948-49.
- B50794 F700P (vertical dip, Export Europe, not France). As 50794 except for bulb.  
Sunbeam-Talbot '90' 1948-49.
- 50806 F575/700 (Export U.S.A.). 12v.; double contact; C.P.R.  
Commer 8 cwt. Van 1949-50.  
Hillman 'Minx' 1948-50.
- 50811 F700 (Export U.S.A.). 12v.; C.P.R.; less light unit.  
Allard 16 1949.  
Alvis TA21 1951.  
Commer 8 cwt. Van 1951-52; 'Express' Delivery Van and Pick-up Truck 1953; 25 cwt. Forward Control 1952-53.  
Hillman 'Minx' 1951-53.  
Humber 'Hawk' and 'Super Snipe' 1948-53; 'Imperial' and 'Pullman' 1951-53.  
Karrier 'Bantam' 1960.  
Sunbeam-Talbot '90' 1951-53.  
Triumph TR3 1958.
- 50812 F700 (Export U.S.A.). 12v.; double contact; less light unit.  
Sunbeam-Talbot '90' 1948-50.
- 50816 R100 (Export U.S.A.). 12v.; C.P. finish; upright fixing; special conversion.  
Rolls-Royce 'Silver Wraith' 1947-55.
- 50820 P100L-EF (Export). Double contact; C.P. finish; upright fixing; less bulb.  
Austin A125 1948-54; DA1 and DH1 1951-55.
- 50822 F575P-1EF (vertical dip, Export). 12v.; double contact; to take 3-pin bulb.  
Morris 'Minor' 1950; 'Minor' 2-door 1951.
- 50825 PF770 (dip left). 12v.; double contact; C.P.R.  
A.F.N. 'Mille Miglia' 1951-54.  
Allard 'J', 'J2' and 'J2X' 1950; 'M' and 'P' Models (alternative) 1949-50.  
Aston Martin DB2 1951-52.  
Austin A135 1948-49.  
Daimler 2½ litre 1950-52.  
Frazer Nash 1955.  
Jensen 4 litre 1950.  
Jowett 'Jupiter' 1951.
- A50825 F700 (dip right, Export). 12v.; double contact; as 50825 except for bulb.  
Daimler 2½ litre 1950-53.  
Frazer Nash 1955.  
Jensen 4 litre 1950.  
Jowett 'Jupiter' 1951.
- B50825 F700 (vertical dip, Export Europe, not France). As 50825 except for bulb.  
Daimler 2½ litre 1950-52.  
Frazer Nash 1955.  
Jensen 4 litre 1950.  
Jowett 'Jupiter' 1951.
- 50838 PF770 (dip left). 12v.; double contact; C.P.R.  
Jaguar XK120 1949-50.
- A50838 PF770 (dip right, Export). As 50838 except for bulb.  
Jaguar XK120 1949-50.
- B50838 PF770 (vertical dip, Export Europe, not France). As 50838 except for bulb.  
Jaguar XK120 1949-50.
- 50841 PF770 (Export). 12v.; C.P.R.; less light unit and bulb.  
Jaguar XK120 1949-50.
- 50849 RF770 (dip left). 12v.; double contact; C.P.R.  
Rolls-Royce 'Silver Wraith' 1951-53.
- B50849 RF770 (vertical dip, Export Europe, not France). As 50849 except for bulb.  
Rolls-Royce 'Silver Wraith' 1951-55.
- 50873 S700 (right hand dip, Export). 12v.; double contact; E.B., C.P.R. finish; upright fixing.  
A.F.N. 'Le Mans' 1952-54.  
Healey 'Silverstone' 1950.  
Morgan 'Plus Four' 1953-54.  
Morris Commercial 15/20 cwt. (PV), 25/30 cwt. (LC3), CV Ambulance, CV11/40 and CV9/40 1951; FV and FVO 1949-54; Petrol Tanker 1951-52; FVSO 1954; PP Coach 1950-52; 'J' Van 1949-50.
- 50874 F700. 12v.; double contact; single filament bulb; C.P.R.  
Douglas Battery Vehicle 1950-51.
- 50877 S700 (right hand dip, Export). 12v.; double contact; C.P. finish; upright fixing.  
A.F.N. 'Le Mans' 1951-52.  
Allard 'J', 'J2' and 'J2X' 1952-55; 'J2R' 1956.  
Citroen 15 and 23 1950-52.  
H.R.G. 9 and 12 1951-52.  
M.G. 1½ litre and 'Midget' 1949-52.  
Morgan 'Plus Four' 1951-53.  
Singer 9 1950-51.
- 50882 F700 (dip left). 12v.; double contact; C.P.R.  
Riley 1½ litre 1946-49; 2½ litre 1946-50.
- 50897 S700 (Export U.S.A.). 12v.; C.P. finish; upright fixing.  
Allard 'J', 'J2' and 'J2X' 1949-51.
- 50900 PF770 (dip left). 12v.; double contact; C.P.R.  
Austin A135 1950.
- 50920 PF770 (dip left). 12v.; double contact; C.P.R.  
Bristol '401' 1951-53.
- 50933 PF770 (dip left). 12v.; double contact; C.P.R.  
Jaguar 2½ litre (later) 1951; 3½ litre 1952-54.
- A50933 PF770 (dip right, Export). As 50933 except for bulb.  
Jaguar 3½ litre 1952-54.
- B50933 PF770 (vertical dip, Export). As 50933 except for bulb.  
Jaguar 2½ litre (later) 1951; 3½ litre 1952-54.
- 50935 PF770EF (Export). 12v.; double contact; C.P.R.  
Jaguar 2½ litre (later) 1951; 3½ litre 1952-54.
- 50936 PF770 (Export). C.P.R.; less light unit.  
Jaguar 2½ litre (later) 1951; 3½ litre 1952-54.

# HEADLAMPS



## VEHICLE APPLICATION REFERENCE—continued

- 50941 F700 (dip left). 12v.; double contact; C.P.R. Allard 'P2', '21C' and '21Z' 1953-54. Austin A40 1953; A70 1952; A70 'Countryman'. Pick-up Truck and A90 (later) 1952. Commer 8 cwt. Van 1952; 'Express' Delivery Van and Pick-up Truck 1953; 25 cwt. 'Superpoise' Van and Medium Pick-up Truck MK. IV 1952-53; 5 and 7 ton Forward Control and 'Avenger' Coach (later) 1952. Hillman 'Minx' 1952-53. Humber 'Hawk', 'Imperial', 'Pullman' and 'Super Snipe' 1952-53. Jensen 4 litre 1952-54. Jowett 'Javelin' and De Luxe 1952-53. Karrier 'Bantam' 1952-53 and 1957-60. Lea Francis 14 and 18 1952; 4 Light Saloon and 2½ litre Sports 1952-53. Morris 'Minor' (later) 1952; 'Cowley' Van and Pick-up Truck (later) 1952; 'Oxford' and 'Six' (later) 1952. Sunbeam-Talbot '90' 1953. Triumph TR3 1958.
- 50942 PF770 (Export). C.P.R.; less light unit. A.F.N. 'Mille Miglia' 1951-54. Aston Martin DB2 1951-52. Frazier Nash 1955. Jowett 'Jupiter' 1951.
- 50947 SS700P. 6v.; E.B., C.P.R. finish; side bolt fixing. Barrett Invalid Carriage 1951-54. Invacar 1952-53. Light Delivery Vehicles 'Bi-van' 1949-51.
- 50967 F700 (vertical dip, Export). 12v.; double contact; C.P.R. Allard 'P2', '21C' and '21Z' 1953-54. Austin A40 1953. Commer 'Express' Delivery Van and Pick-up Truck 1953. Hillman 'Minx' 1953. Humber 'Hawk', 'Imperial', 'Pullman' and 'Super Snipe' 1953. Karrier 'Bantam' 1957-59. Sunbeam-Talbot '90' 1953. Triumph TR3 1958.
- 50973 F700 (dip right, Export). 12v.; double contact; C.P.R. Allard 'P2', '21C' and '21Z' 1953-54. Austin A40 1953. Commer 'Express' Delivery Van and Pick-up Truck 1953. Healey 'Tickford' 1951. Hillman 'Minx' 1953. Humber 'Hawk', 'Imperial', 'Pullman' and 'Super Snipe' 1953. Karrier 'Bantam' 1960. Sunbeam-Talbot '90' 1953. Triumph TR3 1958.
- 50977 F700EF (Export). 12v.; double contact; less bulb and front rim. Rover '75' 1950-51.
- 50981 PF700EF (Export). 12v.; double contact; C.P.R.; to take 3-pin bulb. Daimler 2½ and 3½ litre 1953; 'Regina' 1955.
- 50982 F700P (dip left). 12v.; double contact; C.P.R.; with pilot light. Healey 'Tickford' (later) 1951. Wolseley 'Four Fifty' 1949.
- 50983 F700P (vertical dip, Export). 12v.; double contact; C.P.R.; with pilot light. Aston Martin 2 litre 1947-50. Humber 'Hawk' and 'Super Snipe' 1949. Morris 'Cowley' Van and Pick-up Truck 1950-51; 'Oxford' and 'Six' 1948-51. Singer 'SM1500' 1949. Standard 'Vanguard' 1948-49. Wolseley 'Four Fifty' 1949-51.
- 50984 F700P-EF (vertical dip, Export). 12v.; double contact; C.P.R.; to take 3-pin bulb. Standard 'Vanguard' 1948-49.
- 50986 S700 (vertical dip, Export). 12v.; double contact; C.P. finish; upright fixing. A.F.N. 'Le Mans' 1951-52. Allard 'J', 'J2' and 'J2X' 1951-55; 'J2R' 1956. H.R.G. 9 and 12 1951-52. M.G. 1½ litre 1950-52; 'Midget' 1949-52. Morgan 'Plus Four' 1951-53. Singer 9 1950-51.
- 50987 S700EF (Export). 12v.; double contact; C.P. finish; upright fixing; to take 3-pin bulb; less bulb. Allard 'J', 'J2' and 'J2X' 1951-55; 'J2R' 1956. Singer 9 1950-51.
- 50988 S700 (dip left). 12v.; double contact; C.P. finish; upright fixing. A.C. Cars 16 1952-53. A.F.N. 'Le Mans' 1951-52.
- 50988—continued  
Allard 'J', 'J2' and 'J2X' 1949-55; 'J2R' 1956. Dellow All Models 1952-57. H.R.G. 9 and 12 1951-52. M.G. 1½ litre Tourer 1949-50; 1½ litre Saloon and Tourer 1951-52; 'Midget' 1949-52. Morgan 'Plus Four' 1951-53. Singer 9 1950-51.
- 51023 S700 (dip left). 12v.; double contact; E.B., C.P.R. finish; upright fixing. A.F.N. 'Le Mans' 1953-54. Austin 101 Van 1958-60. M.G. 1½ litre and 'Midget' 1952-53. Morgan 'Plus Four' (later) 1953. Morris Commercial 15/20 cwt. (PV) 1950-53; 25/30 cwt. (LC3) 1950-52; CV Ambulance, CV11/40 and CV9/40 1950-51; 'J' Van 1951-57; 'JB' Van 1958-60.
- 51024 S700 (vertical dip, Export). 12v.; double contact; E.B., C.P.R. finish; upright fixing. Austin 101 Van 1958-59. M.G. 1½ litre and 'Midget' 1952-53. Morris Commercial 15/20 cwt. (PV) 1950-53; 25/30 cwt. (LC3) 1950-52; CV Ambulance, CV11/40 and CV9/40 1950-51; 'J' Van 1951-57; 'JB' Van 1958-59.
- 51025 S700 (dip right, Export). 12v.; double contact; E.B., C.P.R. finish; upright fixing. Austin 101 Van 1958-60. M.G. 1½ litre and 'Midget' 1952-53. Morris Commercial 15/20 cwt. (PV) 1950-53; 25/30 cwt. (LC3) 1950-52; CV Ambulance 1950-51; 'J' Van 1951-57; 'JB' Van 1958-60.
- 51026 S700 (dip left). 12v.; double contact; E.B., C.P.R. finish; upright fixing. A.F.N. 'Le Mans' 1952. Healey 'Silverstone' 1950. Jensen 'Jen-Tug' 1952-54. Morris Quarter Ton Van (G.P.O.) 1955-57. Morris Commercial 15/20 cwt. (PV), 25/30 cwt. (LC3), CV Ambulance, CV11/40, CV9/40, FV and FVO 1949-53; PP Coach and Petrol Tanker 1950-52; FVS and FVSO 1954; 'J' Van 1949-51.
- 51027 S700 (vertical dip, Export). 12v.; double contact; E.B., C.P.R. finish; upright fixing. A.F.N. 'Le Mans' 1952-54. Healey 'Silverstone' 1950. Morgan 'Plus Four' 1953-54. Morris Commercial 15/20 cwt. (PV), 25/30 cwt. (LC3), CV Ambulance, CV11/40, CV9/40 and 'J' Van 1951; FV and FVO 1949-53; PP Coach and Petrol Tanker 1951-52; FVSO 1954.
- 51029 S700 (dip left). 12v.; double contact; E.B., C.P.R. finish; upright fixing. Morris 'Oxford' Taxi and Hire Car 1951.
- 51033 F575 (vertical dip). 6v.; double contact; C.P.R. A.C. Invalid Carriage 1952-53.
- 51044 F575P (vertical dip). 6v.; double contact; C.P.R.; with pilot light. Hartnett Motors (Australia) 1953-56.
- 51054 PF770 (dip left). Double contact; C.P.R. Austin A135 1951-55.
- 51065 PF770 (dip left). 12v.; double contact; C.P.R. Armstrong Siddeley 'Sapphire' 1953-55; 'Sapphire 346' 1956-59. Aston Martin DB2 and DB2/4 1953-55. Daimler 2½ litre (except 'Consort') (Hooper bodies) 1951-53; 2½ litre 'Consort' (later) and 3 litre 1953; 'Regina' 1955. Healey 'Tickford' Abbot 1952-54. Jowett 'Jupiter' 1952-54. Lagonda 3 litre 1954-55.
- AS1065 PF770 (dip right, Export). As 51065 except for bulb. Armstrong Siddeley 'Sapphire' 1953. Daimler 2½ and 3 litre 1952-53; 'Regina' 1955. Jowett 'Jupiter' 1952-54.
- BS1065 PF770 (vertical dip, Export Europe, not France). As 51065 except for bulb. Armstrong Siddeley 'Sapphire' 1953. Daimler 2½ and 3 litre 1952-53; 'Regina' 1955. Jowett 'Jupiter' 1952-54.
- 51067 PF770 (Export). 12v.; C.P.R.; less light unit. Armstrong Siddeley 'Sapphire' 1953-55; 'Sapphire 346' 1956-59; ½ ton Pick-up Truck 1957. Aston Martin DB2 and DB2/4 1954-57. Jowett 'Jupiter' 1952-54. Lagonda 3 litre 1956-57.
- 51073 P700 (dip left). 12v.; double contact; natural finish rim. Rover '60' 1954-56; '75' and '90' 1952-56.
- 51076 S5575. 6v.; double contact; E.B., C.P.R. finish; side bolt fixing. Barrett 'Midget' 1954; 147 c.c. 1953-54; 197 c.c. 1955. Vernons Industries Invalid Carriage 1951-54.
- 51194 PF770EF (Export). Double contact; C.P.R.; to take 3-pin bulb; less body. Jaguar 2½ and 3½ litre 1949-51; XK120 1949-54.
- 51258 F700 (dip left). 12v.; double contact; C.P.R.; insulated return. Austin 2½ ton Petrol Tanker 1952-55.
- 51259 F700 (dip right, Export). 12v.; double contact; C.P.R.; insulated return. Austin 2½ ton Petrol Tanker 1952-55.
- 51292 RF770 (dip left). 12v.; double contact; C.P.R. Bentley 4½ litre and 'Continental' Sports 1952.
- 51295 RF770 (vertical dip, Export). 12v.; double contact; C.P.R. Bentley 4½ litre 1952-54; 'Continental' Sports 1952.
- 51296 RF770 (dip left). 12v.; double contact; C.P.R. Rolls-Royce 'Silver Dawn' 1953-55.
- 51336 F700 (dip left). 12v.; double contact; C.P.R. A.C. Cars 16 1950-52. Allard 'J', 'J2', 'J2X' and 'K3' 1955; 'K' and 'L' Models 1951; 'M' and 'P' Models 1949-51; 'P2' 1952-55; '21C' and '21Z' 1954-55. Alvis All Models 1951-55. Austin A30 1952-56; 'Seven' (850) 1959-60; A35 1957-60; A40 1952-54; A40 Sports 1951; A70 1951-52; A90 1949-52; Austin-Healey '100' and '100M' 1954-56; Taxi and Hire Car 1959-60. Bedford CA Van 1953-60; SH Fire Engine 1951-53; TA 1953-57; TC and TJ 1958-60. Bristol 2 litre 1947-48; '400' and '401' 1949-50. Commer 8 cwt. and 25 cwt. Van and 4½ ton 1950-51; 'Express' Delivery Van and Pick-up Truck 1953-55; 25 cwt. Forward Control 1952-56; 1½/1½ ton Forward Control Mk. V 1956-60; Medium Pick-up Truck Mk. IV 1951; 25 cwt. 'Superpoise' Van 1954-56; Medium Pick-up Truck Mk. IV 1954; ¾/1½ ton 'Superpoise' Van and Medium Pick-up Truck 1956-60; 2/3, 3/4 and 5 ton 1949-54; 'Commando' (Petrol) 1950-53; 2½ and 3½ ton 'Superpoise' Models and 7 ton Forward Control 1955-60; 1, 4, 5 and 6 ton Forward Control and 6 ton 'Superpoise' Models 1959-60; 3/4 and 5 ton 'Superpoise' 1952-54; 5 and 7 ton 1949; 5 and 7 ton Forward Control 1951-54; 5 ton Forward Control 1955-58; 10/12 ton Tractor 1957-60; 6½, 7 and 8 ton Tractor Trailer 1949-50; 'Avenger' Coach 1949-60; Fire Tender 1952-60. Daimler 'Conquest' ('Century') 1954-58; DC27 1949-54. Elva 'Courier' 1959-60. Healey 16 1948; 'Sportsmobile' 1949. Hillman 'Minx' 1949-51; 'Minx' 1953-55; 'Husky' 1955. Humber 'Hawk' and 'Super Snipe' 1950-51 and 1953-55; 'Imperial' and 'Pullman' 1949-51; 'Imperial' and 'Pullman' 1953-54. Jensen 4 litre 1951-52; 4 litre 1955; Lightweight 1954-55; 'Tempo 1500' 1958-60. Jowett 'Javelin' and De Luxe 1951-54. Karrier 'Bantam' 1951 and 1954-56; CK3 1949-52; 'Gamecock' 1953-60; 1½/1½ ton Passenger 1957-60. Lagonda 2½ litre 1949-52. Lanchester 14 1953; 'Sprite' 1955-56. Layton Sports Car 'Jomar' 1959-60. Lea Francis 2½ litre, 14 and 18, 4 and 6 Light Saloon 1950-54; 1½ litre Sports 1949. Morgan 'Plus Four' 1954-60; 'Four Four' 1956-60. Morris 'Minor' 1951-56 and (later) 1960; 'Mini-minor' (Export) 1959-60; 'Cowley' Van and Pick-up Truck 1950-53; 'Cowley' 1955-56; 'Oxford' and 'Six' 1951-56; 'Traveller' 1953-56; 'Hindustan' 1955-56; 'Isis' 1956; Quarter Ton and Half Ton Vans and Pick-up Truck 1954-56; Quarter Ton Van and Pick-up Truck (later) 1960. Reliant 'Regal' Car, 5 cwt. Van and 'Regent Four' Van 1959-60; 'Regent' Mk. II 1955-56. Riley 1½ and 2½ litre 1950; 'Pathfinder' 1955-57. Singer 'SM1500' 1949-54; 'Hunter' 1955. Smiths Delivery Vehicles 'Mobile Shop' 1956-58. Standard 8 and 10 1954-59; 'Companion' Estate Car, 6 cwt. Van and Pick-up Truck 1956-60; 'Pennant' 1958-59; 'Atlas' Van and Pick-up Truck 1959-60. Sunbeam 'Alpine' 1953. Sunbeam-Talbot '90' 1951 and 1953-54. Triumph 2-seater 1954; TR2 and TR3 1955-57. Vauxhall All Models (except 'Victor' and 'Envoy') 1950-60. Wolseley 'Four Fifty' 1951-53; 'Six Ninety' 1953-56.
- 51339 F700 (vertical dip, Export). 12v.; double contact; C.P.R. Allard 'K' and 'L' Models (later) 1951; 'P2' 1952-55; '21C' and '21Z' 1955. Alvis All Models 1951-57.

C.P. ... Chromium plated

C.P.R. ... Chromium plated rim

E.B. ... Ebony black

EF ... Export France

continued

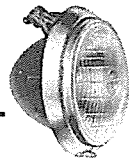

# HEADLAMPS

## VEHICLE APPLICATION REFERENCE—*continued*

### 51339—*continued*

Austin A30 1952-56; A35 1957-59; A40 1952-54; A40 Sports 1951; A70 1951-55; A90 1949-52; Austin-Healey '100' and '100M' 1954-56; Taxi and Hire Car 1959.  
Bedford SH Fire Engine 1951-53; TA 1953-57; TC and TJ 1958-60.  
Bristol '400' and '401' 1949-50; '403' 1954.  
Commer 8 cwt. Van 1950-52; 'Express' Delivery Van and Pick-up Truck 1953-55; 25 cwt. Forward Control 1952-56; 25 cwt. Medium Pick-up Truck and 1½/1 ton Forward Control 1956-59; 25 cwt. 'Superpoise' Van and Medium Pick-up Truck Mk. IV 1950-56; 2/3, 3/4 and 5 ton 1949-54; 'Commando' (Petrol) 1950-53; 2/5 and 3/5 ton 'Superpoise' Models 1955-59; 3/4 and 5 ton 'Superpoise' 1952-54; 1, 4, 5 and 6 ton Forward Control and 6 ton 'Superpoise' 1959; 5 and 7 ton 1949; 5 and 7 ton Forward Control 1950-54 and 1955-59; 10/12 ton Tractor 1957-59; 'Avenger' Coach 1953-59; Fire Tender 1952-59.  
Daimler 2½ litre (except 'Consort') 1953; 'Conquest' ('Century') 1954-58; DC27 1949-54.  
Healey 16 1948.  
Hillman 'Minx' 1950-55; 'Husky' 1955.  
Humber 'Hawk' and 'Super Snipe' 1950-55; 'Imperial' and 'Pullman' 1950-54.  
Jaguar 2.4 litre 1956.  
Jensen 4 litre 1951-55; Lightweight 1955.  
Jowett 'Javelin' and De Luxe 1951-54.  
Karrier 'Bantam' 1951-56; CK3 1949-52; 'Gamecock' 1953-59; 1¼/1 ton Passenger 1957-59.  
Lagonda 2½ litre 1949-52.  
Lanchester 14 1952-53; 'Sprite' 1955-56.  
Lea Francis 14 and 18 1950-54; 4 and 6 Light Saloon and 1½ litre Sports 1952-54.  
Morgan 'Plus Four' 1954-58; 'Four Four' 1956-58.  
Morris 'Minor' and 'Oxford' 1951-56; 'Cowley' Van and Pick-up Truck 1950-53; 'Cowley' 1955-56; 'Oxford' Traveller and 'Hindustan' 1953-56; 'Six' 1951-54; 'Isis' 1956; Quarter and Half Ton Vans and Pick-up Truck 1954-56.  
Reliant 'Regal' Car and 5 cwt. Van 1959-60; 'Regent' Mk. II 1955-56; 'Regent Four' 1959.  
Riley 1½ and 2½ litre 1950; 'Pathfinder' 1955-57.  
Singer 'SM1500' 1951-54; 'Hunter' 1955.  
Smiths Delivery Vehicles 'Mobile Shop' 1956-58.  
Standard 8 and 10 1956-59; 'Companion' Estate Car, 6 cwt. Van and Pick-up Truck 1956-60; 'Pennant' 1958-59; 'Atlas' Van and Pick-up Truck 1959-60.  
Sunbeam 'Alpine' 1953-55.  
Sunbeam-Talbot '90' 1950-54.  
Triumph 2-seater 1954; TR2 and TR3 1956-57.  
Vauxhall All Models (except 'Victor' and 'Envoy') 1950-60.  
Wolseley 'Four Fifty' 1951-53; 'Six Ninety' 1955-56.

51342 F700EF (Export). 12v.; double contact; C.P.R.; to take 3-pin bulb.

A.C. 16 1950.  
Allard 'K' and 'L' Models 1951; 'P2' 1952-55; '21C' and '21Z' 1955.  
Alvis All Models 1952-57.  
Austin A30 1952-56; A35 1957-59; A40 1952-54; A40 Sports 1951; A70 1951-55; A90 1951-52; Austin-Healey '100' and '100M' 1954-56.  
Commer 8 cwt. Van 1950-52; 'Express' Delivery Van and Pick-up Truck 1953-55; 25 cwt. Forward Control 1952-53; 25 cwt. 'Superpoise' Van and Medium Pick-up Truck, 2/3, 3/4, 5 and 7 ton Forward Control and 'Avenger' Coach 1951-54; 'Commando' (Petrol) 1951-53; 2/3 and 3/5 ton 'Superpoise' Models 1956-59; 6 ton 'Superpoise' Models 1959; 4/5 ton 1951; Fire Tender, 3/4 ton and 5 ton 'Superpoise' 1952-54.  
Daimler 'Conquest' ('Century') 1954-58; DC27 1949-54.  
Hillman 'Minx' 1950-55; 'Husky' 1955.  
Humber 'Imperial' and 'Pullman' 1951-53; 'Pullman' 1954; 'Hawk' and 'Super Snipe' 1950-55.  
Jaguar 2.4 litre 1956.  
Jensen 4 litre 1951-55; Lightweight 1955.  
Jowett 'Javelin' and De Luxe 1951-54.  
Karrier 'Bantam' 1951-54; CK3 1951-52; 'Gamecock' 1953-54.  
Lagonda 2½ litre 1951-52.  
Lanchester 14 1952-53; 'Sprite' 1955-56.  
Morgan 'Four Four' 1956-60.  
Morris 'Minor' 1951-56; 'Cowley' Van and Pick-up Truck 1950-53; 'Cowley' 1955-56; 'Oxford' and 'Six' 1951-54; 'Traveller' and 'Hindustan' 1953-56; 'Isis' 1956; Quarter Ton and Half Ton Pick-up Trucks 1954-56.  
Reliant 'Regal' Car 1953-60; 5 cwt. Van 1955-60; 'Regent' Mk. II 1955-56; 'Regent Four' Van 1959.  
Riley 'Pathfinder' 1955-56.  
Singer 'SM1500' 1949-54; 'Hunter' 1955.

### 51342—*continued*

Standard 8 and 10 1954-59; 'Companion' Estate Car, 6 cwt. Van and Pick-up Truck 1956-60; 'Pennant' 1958-59; 'Atlas' Van and Pick-up Truck 1959-60.  
Sunbeam 'Alpine' 1953-55.  
Sunbeam-Talbot '90' 1950-54.  
Triumph 2-seater 1954; TR2 and TR3 1956-58.  
Wolseley 'Four Fifty' 1951-53; 'Six Ninety' 1955-56.

51343 F700 (Export). 12v.; double contact; C.P.R.; less light unit.  
Bristol 'X404' 1954.  
Commer 'Express' Delivery Van and Pick-up Truck 1953-55; 25 cwt. 'Superpoise' Van and Medium Pick-up Truck, 2/3, 3/4 and 5 ton 'Superpoise' 5 and 7 ton Forward Control 1953-54; 'Commando' (Petrol) 1953; 2/5 and 3/5 ton 'Superpoise' Models 1955-60; 6 ton 'Superpoise' Models 1959-60; 5 ton Forward Control 1958; 7 ton Forward Control and 10/12 ton Tractor 1958-60; Fire Tender 1952-54.  
Elva 'Courier' 1959-60.  
Fairthorpe All Models 1958-60.  
Hillman 'Minx' 1953-55; 'Husky' 1955.  
Humber 'Imperial' and 'Pullman' (later) 1953; 'Pullman' 1954; 'Hawk' and 'Super Snipe' 1953-55.  
Jaguar 2.4 litre 1956.  
Morris 'Minor' 1953-56; 'Cowley' Van and Pick-up Truck 1953; 'Cowley' 1955-56; 'Oxford', 'Traveller' and 'Hindustan' 1953-56; 'Six' 1953-54; Quarter Ton and Half Ton Vans and Pick-up Truck 1954-56.  
Reliant 'Regal' Car and 5 cwt. Van 1959-60; 'Regent' Mk. II 1955-56; 'Regent Four' Van 1959.  
Riley 2½ litre (later) 1953; 'Pathfinder' 1953-57.  
Singer 'SM1500' 1953-54; 'Hunter' and 'S' Model 1955-56.

Standard 8 and 10 1958-59; 'Companion' Estate Car, 6 cwt. Van and Pick-up Truck 1958-59; 'Pennant' 1958-59; 'Atlas' Van and Pick-up Truck 1959-60.  
Sunbeam 'Alpine' 1953-55.  
Sunbeam-Talbot '90' 1953-54.  
Wolseley 'Six Ninety' 1955-56.

51344 F700 (dip left). 12v.; double contact; C.P.R.  
A.C. 16 1948-49 and 1951-57; 'Petite' 1953-57.  
Armstrong Siddeley 'Hurricane' and 'Lancaster' 1951-53; Utility 1951-52; 'Whitley' 1950-53; Limousine 1951.  
Austin A40 1948-52; A40 Van, 'Countryman' and Pick-up Truck 1949-56; A40 Sports 1952-53; A70 1948-50; Austin-Healey 'Sprite' 1958-60; Cargo Truck 1954-55; 2 and 5 ton Trucks 1951-55; 3 ton 1955; 7 ton 1956-60; Series IVFG Trucks 1960; Coach 1950-55; Coach and 'Gipsy' 1958-60; 152 and 301 Ranges (except 301FC) 1957-60.

Beardmore Taxi 1955-58.  
Bond 'Minicar' 1958.  
Bristol '404' 1954-55.  
Dodge Petrol Models 1950-60; Diesel P4 and R6 1958-60; P6 1951-60.  
Douglas Battery Vehicle 1952-54.  
Jowett 'Bradford' Van 1953-54.  
Karrier CK3 1947-48.  
Meynell All Models 1952.  
M.G. 'Midget' 1954-55; MGA 1956-60; 'Magnette' 1954-59.  
Morgan 'Plus Four' 1954.  
Morris Commercial All LC Models 1953-60; NV, NVO and NVS 1951-54; FVSO12/5, FVS12/5, NVO12/3, NVO11/5, NV12/3, NVS12/3 and NVS13/5 1955; 'J2' 1957-60; LD1 and LD2 1954-55; 3 ton 3KNC (G.P.O.) 1956-59; Series III Trucks 1956-60; Coach 1957-59; Series IV Trucks 1959-60.  
Paramount Cars 1951-54.  
Riley 1½ litre 1951-55; 2½ litre 1951-53; 'Pathfinder' 1954.  
Rover '80' 1960; 'Land Rover' 1951-60; Station Wagon 1951.  
Trojan 15/20 cwt. Van 1954-60; 25 cwt. Van 1959-60.  
Wolseley 'Four Forty-Four' 1953-56; 'Fifteen Hundred' 1958-60; 'Fifteen Fifty' 1957-59.

51346 F700 (vertical dip, Export). 12v.; double contact; C.P.R.  
A.C. 16 (later) 1952 and 1953-57; 'Petite' 1953-57.  
Armstrong Siddeley 'Hurricane' and 'Lancaster' 1951-53; Utility 1951-52; 'Whitley' 1951-53; Limousine 1951-52.  
Austin A40 1948-52; A40 Van, 'Countryman' and Pick-up Truck 1948-56; A40 Sports 1952-53; A70 1948-50; Austin-Healey 'Sprite' 1958-59; Cargo Truck 1954; 2 and 5 ton Trucks 1951-55; 3 ton 1955; 7 ton 1956-59; Coach 1950-55; 152 Range 1957-59; 'Gipsy' and Coach 1958-59; 301 Range (except 301FC) 1957-60.

### 51346—*continued*

Dodge Petrol Models 1950-60; R6 and P4 (Diesel) 1958-60; P6 (Diesel) 1951-60.  
Jowett 'Bradford' Van 1953-54.  
Karrier CK3 1947-48.  
Meynell All Models 1952.  
M.G. 'Midget' 1954-55; MGA 1956-59; 'Magnette' 1954-59.  
Morris Commercial All LC Models 1953-60; NV, NVO and NVS 1951-54; FVS12/5, NV12/3, NVO12/3, NVO11/5, NVS12/3 and NVS13/5 1955; 'J2' 1957-59; LD1 and LD2 1954-55; Series III Trucks 1956-60; Series IV Trucks 1959-60.  
Paramount Cars 1953-54.  
Riley 1½ litre 1951-55; 2½ litre 1951-53; 'Pathfinder' 1954.  
Rover '60' and '90' 1954-59; '75' 1952-59; '105' 1957-59; 'Land Rover' 1951-59.  
Trojan 15/20 cwt. Van 1958-60; 25 cwt. Van 1959-60.  
Wolseley 'Four Forty-Four' 1953-56; 'Fifteen Hundred' 1958-59; 'Fifteen Fifty' 1957-59.

51369 F700P (dip left). 12v.; double contact; C.P.R.; with pilot light.  
Allard 16 1947-48.  
Armstrong Siddeley 'Hurricane' and 'Lancaster' 1946-50; 'Typhoon' 1948-50; Utility 1950.  
H.R.G. 12 volt (Streamline) 1946.

51370 F700P (dip right, Export). 12v.; double contact; C.P.R.; with pilot light.  
Armstrong Siddeley 'Hurricane', 'Lancaster' and 'Typhoon' 1948-50; Utility 1950.

51371 F700P (vertical dip, Export). 12v.; double contact; C.P.R.; with pilot light.  
Armstrong Siddeley 'Hurricane', 'Lancaster' and 'Typhoon' 1948-50; Utility and 'Whitley' 1950.

51405 S700 (Export). 12v.; double contact; E.B., C.P.R. finish; upright fixing; less light unit.  
M.G. 'Midget' 1953.

51411 F700EF (Export). 12v.; double contact; C.P.R.; to take 3-pin bulb; less bulb.  
A.C. 16 1949 and 1951-57; 'Ace' Sports and 'Acca' Coupé 1957-60.  
Armstrong Siddeley 'Whitley' and Utility 1951; 'Hurricane' and 'Lancaster' 1951-53; Limousine 1951.

Austin A40 1948-52; A40 Van, 'Countryman' and Pick-up Truck 1948-56; A40 Sports 1952-53; A70 1948-50; Austin-Healey 'Sprite' 1958-59; Cargo Truck 1954; 2 and 5 ton Trucks 1951-55; 3 ton 1955; 7 ton 1956-59; Coach 1950-55; Coach and 'Gipsy' 1958-59; 152 Range 1957-59.  
Jowett 'Bradford' Van 1953-54.  
Meynell All Models 1952.  
M.G. 'Midget' 1954-55; MGA 1956-59; 'Magnette' 1954-59.  
Morris Commercial 'J2' 1957-59; Series III Trucks 1956-59; Coach 1959; Series IVFF Trucks 1958-59.  
Paramount Cars 1953.  
Riley 1½ litre 1951-55; 2½ litre 1951-53; 'Pathfinder' 1954-57.  
Rover '60' 1954-59; '75' and '90' 1952-59; '105' 1957-59; 'Land Rover' 1951-59.  
Wolseley 'Four Forty-Four' 1953-56; 'Fifteen Hundred' 1958-59; 'Fifteen Fifty' 1957-59.

51417 F700 (dip left). 12v.; double contact; C.P.R.  
Standard 'Vanguard' 1950-57.  
Sunbeam-Talbot '90' 1952.  
Triumph 'Mayflower' 1950-53.

51419 F700 (vertical dip, Export). 12v.; double contact; C.P.R.  
Standard 'Vanguard' 1950-57.  
Triumph 'Mayflower' 1950-53.

51420 F700EF (Export). 12v.; double contact; C.P.R.; to take 3-pin bulb; less bulb.  
Standard 'Vanguard' 1950-57.  
Triumph 'Mayflower' 1950-53.

51423 RF700EF (vertical dip, Export). 12v.; double contact; C.P. finish; to take 3-pin bulb.  
Rolls-Royce 'Silver Dawn' 1953-55.

51467 F700 (Export). 12v.; double contact; C.P.R.; less light unit.  
Austin 301 range (except 301FC) 1959.  
M.G. 'Midget' 1954-55; MGA 1956-60; 'Magnette' 1955-59.

Morris Commercial 'J2' 1957-59; Series III Trucks and Coach 1959.  
Rover '60' and '90' 1954-59; '75' 1953-59; '105' 1957-59; 'Land Rover' 1951-60.  
Wolseley 'Four Forty-Four' 1956; 'Fifteen Fifty' 1957-59.

51468 F700 (dip left). 12v.; double contact; less rim.  
Austin 'Champ' (Civilian) 1954-56.  
Rover '75' 1950-51.  
Victor Electric Battery Vehicle 1952-55.

# HEADLAMPS

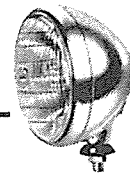

## VEHICLE APPLICATION REFERENCE—continued

51469 F700 (dip right, Export). 12v.; double contact; less rim.  
Austin 'Champ' (Civilian) 1954-56.  
Rover '75' and '90' 1950-51.

51470 F700 (vertical dip, Export). 12v.; double contact; less rim.  
Austin 'Champ' (Civilian) 1954-56.  
Rover '75' 1950-51.

51471 F700EF (Export). 12v.; double contact; to take 3-pin bulb; less rim.  
Austin 'Champ' (Civilian) 1954-56.

51472 PF770LR (vertical dip, Export). 12v.; double contact; C.P.R.  
Jaguar 3½ litre 1953.

51473 MBL140 (dip left). 12v.; double contact; C.P. finish; upright fixing.  
Citroen 15 and 23 1953-55.

51477 F700 (dip left). 24v.; double contact; C.P.R. Bedford SBO, SLO-SSO and SAO 1954-56.  
Commer 6 ton 'Superpoise' (Diesel) 1959-60; 5 ton 'Superpoise' and 'Avenger' 1954-60.

51478 PF770 (vertical dip, Export). 12v.; double contact; C.P.R.  
Jaguar XK120 1952-54.

51479 PF770 (vertical dip, Export). 12v.; double contact; C.P.R.  
Jaguar 3½ litre 1953-54.

51480 PF770 (vertical dip, Export). 12v.; double contact; C.P.R.  
Jaguar XK120 1952-54.

51482 PF770 (dip right, Export). 12v.; double contact; C.P.R.  
Armstrong Siddeley 'Sapphire' 1953-55; 'Sapphire 346' 1956-59.  
Aston Martin DB2/4 1955-57; DB Mk. III 1959.  
Lagonda 3 litre 1956-58.

51483 PF770 (Export, vertical dip). 12v.; double contact; C.P.R.  
Armstrong Siddeley 'Sapphire' 1953-55; 'Sapphire 346' 1956-59.

51484 PF770EF (vertical dip, Export). 12v.; double contact; C.P.R.; to take 3-pin bulb.  
Armstrong Siddeley 'Sapphire' 1953-55; 'Sapphire 346' 1956-59.  
Austin A135 1951-55.  
Jowett 'Jupiter' 1953-54.

51490 F700 (dip right, Export). 24v.; double contact; C.P.R.  
Bedford SBO, SLO-SSO and SAO 1954-56.  
Commer 5 ton 'Superpoise' 1954-60; 6 ton 'Superpoise' (Diesel) 1959-60; 'Avenger' 1955-60.

51492 F700 (vertical dip, Export). 24v.; double contact; C.P.R.  
Bedford SBO, SLO-SSO and SAO 1954-56.  
Commer 5 ton 'Superpoise' 1954-60; 6 ton 'Superpoise' (Diesel) 1959-60; 'Avenger' 1955-60.

51493 RF770 (dip left). 12v.; double contact; C.P.R.  
Bentley 4½ litre 1953-54.

51495 PF770 (dip right, Export). 12v.; double contact; C.P.R.  
Armstrong Siddeley 'Sapphire' 1953-55; 'Sapphire 346' 1956-59.

51496 F700 (dip left). 6v.; double contact; C.P.R.  
Reliant 'Regal' Car 1953-58; 5 cwt. Van 1955-59.

51498 F700 (dip right, Export). 6v.; double contact; C.P.R.  
Reliant 'Regal' Car 1953-58; 5 cwt. Van 1955-58.

51505 F700 (Export). 12v.; double contact; C.P.R.; less light unit.  
Alfa Romeo 'Giulietta' 1957-60; T10 Van (Petrol) 1958-60.  
Nash 'Metropolitan' 1954-60.

51507 PF700 (vertical dip, Export). 12v.; double contact; C.P.R.  
Jaguar 3½ litre 1955-58; Mk. VIII 1957-59; Mk. IX 1959-60; XK140 1955-57; XK150 1958-60.

51509 F700 (dip right, Export). 12v.; double contact; C.P.R.  
Allard 'K', 'L', 'M' and 'P' Models (later) 1951; 'P2' 1952-55; 'K3', '21C' and '21Z' 1954-55.  
Alvis All Models 1951-60.  
Austin A30 1952-56; A35 1957-60; A40 1952-54; A40 Sports 1951; A70 1952-55; A90 1949-52; Austin-Healey '100' and '100M' 1954-56; 'Seven' (850), Taxi and Hire Car 1959-60.  
Bedford CA Van 1953-60; SH Fire Engine 1951-53; TA 1953-57; TC and TJ 1958-60.  
Bristol '400' and '401' 1949-50; '403' 1954.

51509—continued

Commer 8 cwt. Van 1950-52; 'Express' Delivery Van and Pick-up Truck 1953-55; 25 cwt. Forward Control 1952-56; 1 and 1½ ton Forward Control 1956-60; 25 cwt. 'Superpoise' Van and Medium Pick-up Truck Mk. IV 1950-60; 2/3 and 3/4 ton 1949-54; 4/5 ton 1949-51; 'Commando' (Petrol) 1950-53; 2/5 and 3/5 ton 'Superpoise' and 7 ton Forward Control 1955-60; 4/5 ton 1950-51; 3/4 and 5 ton 'Superpoise' 1952-54; 4, 5 and 6 ton Forward Control and 6 ton 'Superpoise' 1959-60; 5 and 7 ton 1949; 5 and 7 ton Forward Control 1950-54; 5 ton Forward Control 1955-58; 10/12 ton Tractor 1957-60; 6½ and 7 ton 1949-50; 8 ton Tractor Trailer 1950; 'Avenger' Coach 1949-60; Fire Tender 1952-60.  
Daimler 'Conquest' ('Century') 1954-58; DC27 1949-54.  
Frisky 1958-59.  
Healey 16 1948.  
Hillman 'Minx' 1950-52 and (later) 1953-55.  
Humber 'Hawk' and 'Super Snipe' 1950-55; 'Imperial' and 'Pullman' 1950-54.  
Jensen 4 litre 1951-55; Lightweight 1955.  
Jowett 'Javelin' De Luxe 1951-54.  
Karrier 'Bantam' 1951-59; CK3 1949-52; 'Gamecock' 1953-60; 1½ ton Passenger 1957-60.  
Lagonda 2½ litre 1949-52.  
Lanchester 14 1952-53; 'Sprite' 1955-56.  
Lea Francis 14 1950-54; 14 and 18 (4 and 6 Light) Saloons 1951-54; 1½ litre Sports 1952-54.  
Morgan 'Plus Four' 1954-60; 'Four Four' 1956-60.  
Morris 'Minor' 1951-56 and (later) 1960; 'Mini-minor' 1959-60; 'Cowley' Van and Pick-up Truck 1950-53; 'Cowley' 1955-56; 'Oxford' 1949-56; 'Traveller' 1953-56; 'Hindustan' 1955-56; 'Six' 1948-54; Quarter Ton and Half Ton Vans and Pick-up Truck 1954-56 and (later) 1960.  
Morrison Electriccars 25 cwt. B1/LH 1955-56.  
Reliant 'Regal' Car, 5 cwt. Van and 'Regent Four' Van 1959-60; 'Regent' Mk. II 1955-56.  
Riley 1½ and 2½ litre 1950; 'Pathfinder' 1955-56.  
Singer 'SM1500' 1949-54; 'Hunter' 1955-56.  
Smiths Delivery Vehicles 'Mobile Shop' 1956-58.  
Standard 8 and 10 1954-59; 'Companion' Estate Car, 6 cwt. Van and Pick-up Truck 1956-60; 'Pennant' 1958-59; 'Atlas' Van and Pick-up Truck 1959-60.  
Sunbeam 'Alpine' 1953-57.  
Sunbeam-Talbot '90' 1950-54.  
Triumph 2-seater 1954; TR2 1955-56; TR3 1956-57.  
Vauxhall All Models (except 'Victor' and 'Envoy') 1950-60.  
Wolsley 'Four Fifty' 1951-53.

51515 F700 (dip left). 12v.; double contact; C.P.R.  
Austin A40 1955-57; A90 and A95 1955-56; All LD Models 1955-60; LCFO 1958; 301FC 1959; 3 and 5 ton 1956-59; 4 ton 1957-59; 3 ton (303) 4 ton (403) and 5 ton (503) 1960; 5 ton (504) 1959-60; Coach 1957.  
Morris Commercial All LD Models 1956-60; LCFO 1958-59.

51516 F700 (dip right, Export). 12v.; double contact; C.P.R.  
Austin A40, A90 and A95 1955-56; LD Models 1955-60; LCFO 1958; 301FC 1959; 3 and 5 ton 1956-59; 4 ton 1957-59; 3 ton (303) 4 ton (403) and 5 ton (503) 1960; 5 ton (504) 1959-60; Coach 1957.  
Morris Commercial All LD Models 1956-60; LCFO 1958-59.

51517 F700 (vertical dip, Export). 12v.; double contact; C.P.R.  
Austin A40 1955-57; A90 and A95 1955-56; All LD Models 1955-60; LCFO 1958; 301FC 1959; 3 and 5 ton 1956-59; 4 ton 1957-59; 5 ton (504) 1959-60; Coach 1957.  
Morris Commercial All LD Models 1957-59; LCFO 1958-59.

51518 F700EF (vertical dip, Export). 12v.; double contact; C.P.R.; to take 3-pin bulb.  
Austin A40 1955-57; A90 and A95 1955-56; All LD Models 1955-60; LCFO 1958; 301FC 1959; 3 and 5 ton 1956-59; 4 ton 1957-59; 5 ton (504) 1959-60; Coach 1957.  
Morris Commercial All LD Models 1957-59; LCFO 1958-59.

51529 F700 (vertical dip, Export). 12v.; double contact; C.P.R.  
Standard 'Vanguard' 1954-57.

51530 F700 (dip right, Export). 12v.; double contact; C.P.R.  
Standard 'Vanguard' 1950-57.  
Triumph 'Mayflower' 1950-53.

51533 F700 (dip right, Export). 12v.; double contact; C.P.R.  
A.C. Cars 16 (later) 1952-57; 'Petite' 1953-57.  
Armstrong Siddeley 'Hurricane' and 'Lancaster' 1951-53; Utility and Limousine 1951-52; 'Whitley' 1950-53.  
Austin A40 1948-51; A40 Van, 'Countryman' and Pick-up Truck 1949-56; A40 Sports 1952-53; A70 1948-50; A90 1949; Austin-Healey 'Sprite' 1958-60; Cargo Truck 1954; 2 and 5 ton Trucks 1951-55; 3 ton 1955; 7 ton 1956-60; Series IVFG Trucks 1960; Coach 1950-55; Coach and 'Gipsy' 1958-60; 152 Range 1959-60; 301 Range (except 301FC) 1957-60.  
Dodge Petrol Models (later) 1951-60; Diesel Models (Perkins engines) 1951-60.  
Jowett 'Bradford' Van 1953-54.  
Karrier CK3 1947-48.  
Meynell All Models 1952.  
M.G. 'Midget' 1954-55; MGA 1956-60; 'Magnette' 1954-59.  
Morris Commercial All LC Models 1953-60; NV 1954; NVO and NVS 1951-54; FVS12/5, FVSO12/5, NVO12/3, NVO11/5, NV12/3, NVS12/3 and NVS13/5 1955; 'J2' 1957-60; LD1 and LD2 1954-55; Series III Trucks 1956-60; Coach 1957-59; Series IV Trucks 1959-60.  
Paramount Cars 1953-54.  
Riley 1½ litre 1951-55; 2½ litre 1951-53; 'Pathfinder' 1954.  
Rover '60' 1954-59; '75' 1952-59; '90' 1954-59; '105' 1957-59; '80' and '100' 1960; 'Landrover' 1951-60.  
Swallow Coachbuilding 'Doretta' 1954-55.  
Wolsley 'Four Forty-Four' 1955-56; 'Fifteen Hundred' 1958-60; 'Fifteen Fifty' 1957-59.

51534 F700LR (vertical dip, Export). 12v.; double contact; C.P.R.  
A.C. Cars 'Ace' and 'Aceca' 1957-60.  
Aston Martin DB4GT 1960.  
Cooper 'Monaco' Sports 1959-60.

51535 F700LR (vertical dip, Export). 12v.; double contact; C.P.R.  
Allard 'J', 'J2' and 'J2X' 1955.  
Daimler 'Conquest' Roadster and Drophead Coupé 1954-57.  
Frazer Nash (alternative) 1955.  
Jensen '541' 1959-60.  
Standard 8 and 10 1954-59; 'Companion' Estate Car, 6 cwt. Van and Pick-up Truck 1959-60; 'Pennant' 1958-59; 'Atlas' Van and Pick-up Truck 1959-60.  
Triumph 2-seater 1954; TR2 and TR3 1955-57.

51536 F700 (vertical dip, Export). 12v.; double contact; C.P.R.  
Standard 8 and 10 1954-59; 'Companion' Estate Car, 6 cwt. Van and Pick-up Truck 1956-60; 'Pennant' 1958-59; 'Atlas' Van and Pick-up Truck 1959-60.  
Triumph 2-seater 1954; TR2 and TR3 1955-57.

51537 F700LR (vertical dip, Export). 12v.; double contact; C.P.R.  
Standard 'Vanguard' 1954-57.

51538 P700 (dip left). 12v.; double contact; C.P.R.  
A.C. Cars 'Ace' Sports and 'Aceca' Coupé 1955-60.  
M.G. 'Magnette' 1954-59.  
Riley 1½ litre (alternative) 1954-55; 'Pathfinder' 1954.  
Rover '60', '75' and '90' 1957-59; '105' 1959; '100' 1960.  
Swallow Coachbuilding 'Doretta' 1954-55.

51546 P700 (dip left). 12v.; double contact; C.P.R.  
Bristol '405' 1955-58.  
Humber 'Super Snipe' 1955.  
Jensen 4 litre De Luxe 1955; '541' 1954-58.  
Riley 'Pathfinder' 1957.  
Sunbeam 'Alpine' 1954-55.  
Sunbeam-Talbot '90' 1954.  
Triumph 2-seater 1954; TR2 and TR3 1955-57.

51553 PF770LR (vertical dip). 12v.; double contact; C.P.R.  
Armstrong Siddeley 'Sapphire' 1954-55; 'Sapphire 346' 1956-59.

51560 PF770LR (vertical dip). 12v.; double contact; C.P.R.  
Aston Martin DB2 1954; DB2/4 1956-57; DB3/S 1956; DB Mk. III 1959.  
Lagonda 3 litre 1956-58.

51561 PF770EF (vertical dip, Export). 12v.; double contact; C.P.R.; to take 3-pin bulb.  
Aston Martin DB2 1954; DB2/4 1956-57.  
Lagonda 3 litre 1956-58.

51562 PF700 (Export). 12v.; double contact; C.P.R.; less light unit.  
Jaguar 3½ litre 1955-58; XK140 and XK150 1955-59.

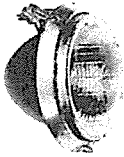

# HEADLAMPS

## VEHICLE APPLICATION REFERENCE—continued

- 51563 PF700EF (vertical dip, Export). 12v.; double contact; C.P.R.; to take 3-pin bulb. Jaguar 3½ litre, Mk. VIII and Mk. IX 1955-60; XK140 and XK150 1955-56.
- 51564 PF700 (vertical dip, Export). 12v.; double contact; C.P.R. Jaguar 3½ litre, Mk. VIII and Mk. IX 1955-60; XK140 and XK150 1955-60.
- 51565 PF700 (vertical dip, Export). 12v.; double contact; C.P.R. Jaguar Mk. VIII and Mk. IX 1957-60; XK140 and XK150 1955-60.
- 51587 F700 (Export). 12v.; double contact; less light unit and rim. Jowett 'Javelin' De Luxe 1953. Rover '75' 1951.
- 51591 F700LR-EF (vertical dip, Export). 12v.; double contact; C.P.R.; to take 3-pin bulb. Bristol '403' 1954. Daimler 'Conquest' 1954-57.
- 51592 F700P (dip left). 12v.; double contact; C.P.R.; with pilot light. Allard 16 1948-49; 'K' and 'L' Models 1949-50. Aston Martin 2 litre 1947-50. Healey 16 1949. Humber 'Hawk' 1949; 'Imperial' and 'Pullman' 1948; 'Super Snipe' 1947-49. Lea Francis 1½ and 2½ litre Sports 1949-50. Morris 'Cowley' Van and Pick-up Truck 1950-51; 'Oxford' and 'Six' 1948-51. Singer 'SM1500' 1949-50. Standard 'Vanguard' 1948-49. Tornado 'Typhoon' 1959-60. Wolseley 'Four Fifty' 1949-51.
- 51596 P700 (dip left). 12v.; double contact; C.P.R. Allard 'K3' 1954; 'P2' (alternative) 1953-55. Alvis All Models (alternative) 1954-57. Austin A40 Van, 'Countryman' and Pick-up Truck 1953-56. Bristol '401' 1953; '403' 1954. Riley 'Pathfinder' 1955-56.
- 51602 F700 (dip left). 12v.; double contact; C.P.R. Bentley 'Continental' Sports and Sports Saloon 1955-56; 'Continental' Sports and Model 'S' 1957-59.
- 51603 F700 (dip right, Export). 12v.; double contact; C.P.R. Bentley 'Continental' Sports and Sports Saloon 1955-56; 'Continental' Sports and Model 'S' 1957-59; 'Continental' Sports and Model 'S2' 1960.
- 51604 F700 (vertical dip, Export). 12v.; double contact; C.P.R. Bentley 'Continental' Sports and Sports Saloon 1955-56; 'Continental' Sports and Model 'S' 1957-59. Rolls-Royce 'Silver Wraith' and 'Silver Cloud' 1956-59.
- 51605 F700EF (vertical dip, Export). 12v.; double contact; C.P.R.; to take 3-pin bulb. Bentley Sports Saloon 1955-56; 'Continental' Sports 1955-59. Rolls-Royce 'Silver Wraith' 1956-59.
- 51606 F700 (dip right, Export). 12v.; double contact; C.P.R. Bentley 'Continental' Sports and Sports Saloon 1955-56; 'Continental' Sports and Model 'S' 1957-59; 'Continental' Sports and 'S2' Model 1960. Rolls-Royce 'Silver Wraith' and 'Silver Cloud' 1956-59; 'Silver Cloud' and 'Phantom' 1960.
- 51607 F700 (Export). 12v.; double contact; C.P.R.; less light unit. Bentley 'Continental' Sports and Sports Saloon 1955-56; 'Continental' Sports and Model 'S' 1957-59. Rolls-Royce 'Silver Wraith' and 'Silver Cloud' 1956-59.
- 51639 F700 (dip left). 24v.; double contact; C.P.R. Dodge 24 volt Models 1954-60.
- 51640 F700 (dip right, Export). 24v. double contact; C.P.R. Dodge 24 volt Models 1954-60.
- 51641 F700 (vertical dip, Export). 24v.; double contact; C.P.R. Dodge 24 volt Models 1954-60.
- 51644 ML143 (dip left, L.H.). 12v.; double contact; E.B., C.P.R. finish; 90° fixing. Austin Taxi and Hire Car 1955-58.
- 51645 ML143 (dip left, R.H.). 12v.; double contact; E.B., C.P.R. finish; 90° fixing. Austin 10 1946; Taxi 1948-58; Hire Car 1952-55; 2 and 5 ton Trucks 1949-50; Coach 1947-49.
- 51646 PF770 (dip right, Export). 12v.; double contact; C.P.R. Daimler 'Empress' and 'Regency' 1955; 'One-O-Four' 1956-59; 4½ litre 1956-60; 'Majestic' 1959-60.
- 51670 F709 (dip left). 12v.; double contact; C.P.R. Standard 'Vanguard' 1956; 'Ensign' 1958.
- 51671 ML143 (dip right, L.H., Export). 12v.; double contact; C.P. finish; 90° fixing. Austin Hire Car 1956-58.
- 51672 ML143 (dip right, R.H., Export). 12v.; double contact; C.P. finish; 90° fixing. Austin Hire Car 1956-58.
- 51673 ML143 (vertical dip, L.H., Export). 12v.; double contact; C.P. finish; 90° fixing. Austin 10 1946-47; Hire Car 1956-58.
- 51674 ML143 (vertical dip, R.H., Export). 12v.; double contact; C.P. finish; 90° fixing. Austin 10 1946-47; Hire Car 1951-54 and 1956-58.
- 51675 ML143EF (vertical dip, L.H., Export). 12v.; double contact; C.P. finish; 90° fixing; to take 3-pin bulb; less bulb. Austin Hire Car 1956-58.
- 51676 ML143EF (vertical dip, R.H., Export). 12v.; double contact; C.P. finish; 90° fixing; to take 3-pin bulb. Austin Hire Car 1956-58.
- 51677 ML143 (dip left, L.H.). 12v.; double contact; C.P. finish; 90° fixing. Austin Hire Car 1956-58.
- 51678 ML143 (dip left, R.H.). 12v.; double contact; C.P. finish; 90° fixing. Austin 10 1947; Hire Car 1950-52 and 1956-58.
- 51682 S700 (Export). 12v.; double contact; E.B., C.P.R. finish; upright fixing; less light unit. Austin 101 Van 1958-59. Morris Commercial 'J' Van 1956-57; 'JB' Van 1958-60.
- 51698 PF700 (dip left). 12v.; double contact; C.P.R. Daimler 'Empress' and 'Regency' 1955; 'One-O-Four' 1956-59; 4½ litre 1956-60; 'Majestic' 1959-60.
- 51699 PF700 (dip right, Export). 12v.; double contact; C.P.R. Daimler 'Empress' and 'Regency' 1955; 'One-O-Four' 1956-59; 4½ litre 1956-60; 'Majestic' 1959-60.
- 51700 PF700 (vertical dip, Export). 12v.; double contact; C.P.R. Daimler 'Empress' and 'Regency' 1955; 'One-O-Four' 1956-59; 4½ litre 1956-60; 'Majestic' 1959-60.
- 51701 PF700EF (vertical dip, Export). 12v.; double contact; C.P.R.; to take 3-pin bulb. Daimler 'Empress' and 'Regency' 1955; 'One-O-Four' 1956-59; 4½ litre 1956-60; 'Majestic' 1959-60.
- 51730 F700 (dip left). 12v.; double contact; C.P.R. Rolls-Royce 'Silver Wraith' and 'Silver Cloud' 1956-59.
- 51736 F700 (dip left). 12v.; double contact; C.P.R. Commer 'Express' Delivery Van and Pick-up Truck 1956-60; 'Cob' 1957; ½ ton Forward Control Van and Passenger Chassis 1960. Hillman 'Minx' 1956; 'Husky' Series I 1956-57. Humber 'Hawk' 1956-57. Morris 'Cowley' 1957-59; 'Isis' 1957-58; 'Minor' and Quarter and Half Ton Vans 1957-60. Singer 'Hunter' and 'S' Models 1956. Sunbeam 'Alpine' 1956-57. Wolseley 'Six Ninety' 1957-59.
- 51737 F700 (dip right, Export). 12v.; double contact; C.P.R. Commer 'Express' Delivery Van and Pick-up Truck 1956. Hillman 'Minx' 1956. Humber 'Hawk' and 'Super Snipe' 1956. Morris 'Cowley' 1957-59; 'Isis' 1957-58; 'Minor' and Quarter and Half Ton Vans 1957-60. Singer 'Hunter' and 'S' Model 1956. Wolseley 'Six Ninety' 1957-59.
- 51738 F700 (vertical dip, Export). 12v.; double contact; C.P.R. Commer 'Express' Delivery Van and Pick-up Truck 1956-59; 'Cob' 1957. Hillman 'Minx' 1956; 'Husky' 1958. Humber 'Hawk' and 'Super Snipe' 1956-57. Jaguar 2.4 litre 1957-60; 3.4 and 3.8 litre 1958-60. Morris 'Isis' 1957-58; 'Minor', 'Cowley' and Quarter and Half Ton Vans 1957-59. Singer 'Hunter' and 'S' Model 1956. Sunbeam 'Alpine' 1956-57. Wolseley 'Six Ninety' 1957-59.
- 51739 F700EF (vertical dip, Export). 12v.; double contact; C.P.R.; to take 3-pin bulb; less bulb. Commer 'Express' Delivery Van and Pick-up Truck 1956-59; 'Cob' 1957. Hillman 'Minx' 1956; 'Husky' 1956-57. Humber 'Hawk' 1956-57. Morris 'Isis' 1957-58; 'Minor', 'Cowley' and Quarter and Half Ton Vans 1957-59. Sunbeam 'Alpine' 1956-57. Wolseley 'Six Ninety' 1957-59.
- 51741 F700 (Export). 12v.; double contact; C.P.R.; less light unit. Commer 'Express' Delivery Van and Pick-up Truck 1956-60; 'Cob' 1957. Hillman 'Minx' 1956; 'Husky' 1956-57. Humber 'Hawk' and 'Super Snipe' 1956-57. Jaguar 2.4 litre 1957-59; 3.4 litre 1958-59. Morris 'Isis' 1957-58; 'Minor', 'Cowley' and Quarter and Half Ton Vans and Pick-up Truck 1957-60. Sunbeam 'Alpine' 1956-57. Wolseley 'Six Ninety' 1957-59.
- 51742 F700 (dip left). 12v.; double contact; C.P.R. Humber 'Hawk' and 'Super Snipe' 1956-57. Sunbeam 'Alpine' 1956-57.
- 51752 F700 (dip right, Export). 12v.; double contact; C.P.R. Rolls-Royce 'Silver Wraith' and 'Silver Cloud' 1956-59; 'Silver Cloud' and 'Phantom' 1960.
- 51762 J700 (dip left). 12v.; double contact; C.P.R. Jaguar 3½ litre 1955; Mk. VIII and Mk. IX 1957-60; XK140 and XK150 1955-60.
- 51763 J700 (dip right, Export). 12v.; double contact; C.P.R. Jaguar 3½ litre 1955-58; Mk. VIII and Mk. IX 1957-60; XK140 and XK150 1955-60.
- 51766 F700 (vertical dip, Export). 12v.; double contact; C.P.R. Jaguar XK-SS 1958.
- 51767 F700 (dip left). 12v.; double contact; C.P.R. Jaguar 2.4 litre 1956-58; 3.4 litre 1958.
- 51769 MCF575 (vertical dip). 6v.; double contact; C.P.R. Tippen Invalid Carriage 1955-56.
- 51777 F700 (dip left). 12v.; double contact; C.P.R.; peaked. Commer 'Cob' Series II 1960. Hillman 'Minx' 1957-59; 'Husky' Series II 1960.
- 51779 F700 (Export). 12v.; double contact; C.P.R.; less light unit. Commer 'Cob' Series II 1960. Hillman 'Minx' 1957-59; 'Husky' Series II 1960.
- 51784 F700 (Export). 12v.; double contact; C.P.R.; less light unit. Austin All LD Models, LCFO and 301FC 1958-59. Morris Commercial All LD Models 1956-59; LCFO 1958-59.
- 51785 F700EF (Export). 12v.; double contact; C.P.R.; peaked; to take 3-pin bulb; less bulb. Hillman 'Minx' 1957-59.
- 51791 F700 (dip right, Export). 12v.; double contact; C.P.R. Jaguar 2.4 litre 1956-60; 3.4 litre 1958.
- 51792 F700 (vertical dip, Export). 12v.; double contact; C.P.R. Jaguar 3.4 and 3.8 litre 1958-60.
- 51794 F700 (dip left). 12v.; double contact; C.P.R. Sunbeam 'Rapier' 1956-57.
- 51795 F700 (dip right, Export). 12v.; double contact; C.P.R. Sunbeam 'Rapier' 1956.
- 51796 F700EF (vertical dip, Export). 12v.; double contact; to take 3-pin bulb; less bulb. Singer 'Gazelle' 1958-59. Sunbeam 'Rapier' 1956-57.
- 51797 F700 (Export). 12v.; double contact; C.P.R.; less light unit. Singer 'Gazelle' 1957-59. Sunbeam 'Rapier' 1956-57.
- 51808 PF700 (dip left). 12v.; double contact; C.P.R. Austin A135 1956; Ambulance and Hearse 1956-59.
- 51810 PF700 (dip right, Export). 12v.; double contact; C.P.R. Austin A135 1956; Ambulance and Hearse 1956-59.
- 51811 PF700 (vertical dip, Export). 12v.; double contact; C.P.R. Austin A135 1956; Ambulance and Hearse 1956-59.
- 51812 PF700EF (vertical dip, Export). 12v.; double contact; to take 3-pin bulb; less bulb. Austin A135 1956; Ambulance and Hearse 1956-59.



# HEADLAMPS



## VEHICLE APPLICATION REFERENCE—continued

- 51816 F700 (vertical dip, Export). 12v.; double contact; C.P.R.  
Bentley Sports Saloon 1955-56; 'Continental' Sports 1955-59; Model 'S' 1957-59.  
Rolls-Royce 'Silver Wraith' and 'Silver Cloud' 1956-59.
- 51878 F700 (dip left). 12v.; double contact; C.P.R.; insulated return.  
Austin 3/4 and 3/5 ton Tanker 1957-60.
- 51879 F700 (dip right, Export). 12v.; double contact; C.P.R.; insulated return.  
Austin 3/4 and 3/5 ton Tanker 1957-60.
- 51880 F700 (vertical dip, Export). 12v.; double contact; C.P.R.; insulated return.  
Austin 3/4 and 3/5 ton Tanker 1957-60.
- 51882 F700 (dip left). 12v.; double contact; C.P.R.; insulated return.  
Austin 7 ton Tanker 1958.  
Morris Commercial Tanker 1957-60.
- 51883 F700 (dip right, Export). 12v.; double contact; C.P.R.; insulated return.  
Austin 7 ton Tanker 1958.  
Morris Commercial Tanker 1957-60.
- 51884 F700 (vertical dip, Export). 12v.; double contact; insulated return.  
Austin 7 ton Tanker 1958.  
Morris Commercial Tanker 1957-60.
- 51886 F700EF (vertical dip, Export). 12v.; double contact; to take 3-pin bulb.  
Jaguar 2.4 litre 1957-60; 3.4 and 3.8 litre 1958-60.  
Singer 'Hunter' and 'S' Model 1956.
- 51891 F700 (dip left). 12v.; double contact; C.P.R.  
Armstrong Siddeley 'Sapphire 234' and 'Sapphire 236' 1956-58.
- 51895 F700 (vertical dip, Export). 12v.; double contact; C.P.R.  
Standard 'Vanguard' 1956; 'Ensign' 1958.
- 51896 F700EF (vertical dip, Export). 12v.; double contact; C.P.R.; to take 3-pin bulb; less bulb.  
Standard 'Vanguard' 1956; 'Ensign' 1958.
- 51897 F700 (vertical dip, Export). 12v.; double contact; C.P.R.  
Standard 'Vanguard' 1956; 'Ensign' 1958.
- 51898 F700 (vertical dip, Export). 12v.; double contact; C.P.R.  
Standard 'Vanguard' 1956; 'Ensign' 1958.
- 51899 F700 (dip right, Export). 12v.; double contact; C.P.R.  
Standard 'Vanguard' 1956; 'Ensign' 1958.
- 51901 F700 (dip left). 12v.; double contact; C.P.R.  
Standard 'Vanguard' 1958-60; 'Sportsman' 1957-58.
- 51906 SS700 (vertical dip). 6v.; double contact; C.P.R.; side bolt fixing.  
George Fitt 1951-55.  
Invacar 1951 and 1954-55.  
Light Delivery Vehicles 'Tri-Van' 1949-51.  
Reliant 750 c.c. 3-wheeler 1946-54; 6 cwt. Van and Truck 1954-55; 10 cwt. and 'Regent' 1951-56.
- 51919 PF700 (dip left). 12v.; double contact; C.P.R.  
Austin A135 (later) 1956; A135 (Export) 1956-57; 'Princess' Mk. IV (Export) 1957.
- 51920 PF700 (dip left). 12v.; double contact; C.P.R.  
Austin A135 and 'Princess' Mk. IV 1957.
- 51921 PF700 (dip right, Export). 12v.; double contact; C.P.R.  
Austin A135 1956-57; 'Princess' 1957.
- 51922 PF700 (vertical dip, Export). 12v.; double contact; C.P.R.  
Austin A135 1956-60; 'Princess' Mk. IV 1957-59; Ambulance and Hearse 1959-60.
- 51923 PF700EF (vertical dip, Export). 12v.; double contact; C.P.R.; to take 3-pin bulb.  
Austin A135 1956-60; 'Princess' Mk. IV 1957-59; Ambulance and Hearse 1959-60.
- 51928 F700 (Export American Market). 12v.; double contact; less light unit and rim.  
Alfa Romeo 'Giulietta' 1956-60; T10 Van (Petrol) 1958-60.  
Simca 'Aronde' De Luxe 1959.
- 51935 F700 (vertical dip, Export). 12v.; double contact; C.P.R.  
Standard 'Vanguard' 1958-60; 'Sportsman' 1957-58.
- 51936 F700EF (vertical dip, Export). 12v.; double contact; C.P.R.; to take 3-pin bulb; less bulb.  
Standard 'Vanguard' 1958-60; 'Sportsman' 1957-58.
- 51937 F700 (vertical dip, Export). 12v.; double contact; C.P.R.  
Standard 'Vanguard' 1958-60; 'Sportsman' 1957-58.
- 51938 F700 (vertical dip, Export). 12v.; double contact; C.P.R.  
Standard 'Vanguard' 1958-60; 'Sportsman' 1957-58.
- 51939 F700 (dip right, Export). 12v.; double contact; C.P.R.  
Standard 'Vanguard' 1958-60; 'Sportsman' 1957-58.
- 51941 F700 (vertical dip, Export). 12v.; double contact; C.P.R.; peaked.  
Hillman 'Minx' 1957-59.
- 51942 F700 (vertical dip, Export). 12v.; double contact; C.P.R.; peaked.  
Singer 'Gazelle' 1958-59.  
Sunbeam 'Rapier' 1957.
- 51946 F700 (dip left). 12v.; double contact; C.P.R.; peaked.  
Humber 'Hawk' 1958-60; 'Super Snipe' 1960.
- 51947 F700 (vertical dip, Export). 12v.; double contact; C.P.R.; peaked.  
Humber 'Hawk' 1958-59; 'Super Snipe' 1959.
- 51948 F700EF (vertical dip, Export). 12v.; double contact; C.P.R.; peaked; to take 3-pin bulb; less bulb.  
Humber 'Hawk' 1958-59; 'Super Snipe' 1959.
- 51949 F700 (Export American Market). 12v.; double contact; C.P.R.; peaked; less light unit.  
Humber 'Hawk' 1958-60; 'Super Snipe' 1959-60.
- 51953 F700 (dip right, Export). 12v.; double contact; C.P.R.  
Armstrong Siddeley 'Sapphire 236' and 'Sapphire 234' 1956-58.
- 51956 F700 (dip left). 12v.; double contact; C.P.R.  
Austin-Healey '100 Six' 1957-59; '3000' 1959-60.
- 51957 F700 (dip right, Export). 12v.; double contact; C.P.R.  
Austin-Healey '100 Six' 1957-59; '3000' 1959-60.
- 51958 F700EF (vertical dip, Export France). 12v.; double contact; C.P.R.; to take 3-pin bulb; less bulb.  
Austin A90 and A95 1957; Austin-Healey '100 Six' 1957-59.
- 51959 F700 (vertical dip, Export). 12v.; double contact; C.P.R.  
Austin-Healey '100 Six' 1957-59.
- 51960 F700 (vertical dip). 12v.; double contact; less rim.  
Lotus Mk. IX 1958-59.
- 51967 F700 (dip left). 12v.; double contact; C.P.R.; peaked.  
Austin A90, A95 and A105 1957.
- 51968 F700 (dip right, Export). 12v.; double contact; C.P.R.; peaked.  
Austin A105 1957.
- 51969 F700 (vertical dip, Export). 12v.; double contact; C.P.R.; peaked.  
Austin A90, A95 and A105 1957.
- 51970 F700EF (vertical dip, Export). 12v.; double contact; C.P.R.; peaked; to take 3-pin bulb; less bulb.  
Austin A90, A95 and A105 1957.
- 51971 F700 (dip left). 12v.; double contact; C.P.R.; die cast.  
Commer 'Cob' 1958-60.  
Hillman 'Minx Special' 1958-59; 'Husky' Series I 1958-60.  
Singer 'Gazelle' 1957.
- 51972 F700 (dip right, Export). 12v.; double contact; C.P.R.  
A.C. 'Ace' and 'Aceca' 1956-60.
- 51982 F700 (vertical dip, Export). 12v.; double contact; C.P.R.  
Nash 'Metropolitan' 1956-60.
- 51987 F700 (dip right, Export). 12v.; double contact; C.P.R.  
Morris 'Cowley' and 'Isis' 1957-58; Quarter Ton Van 1959; Half Ton Van 1958-60; Wolseley 'Six Ninety' 1957-59.
- 51988 F700P (vertical dip). 12v.; double contact; C.P.R.; with pilot light.  
Citroen DS19 1956-60; 1D19 1959-60; 'Safari' 1960.
- 51989 F700 (vertical dip, Export). 12v.; double contact; C.P.R.  
Commer 'Cob' 1958-59.  
Hillman 'Minx Special' and 'Husky' 1958-59.  
Singer 'Gazelle' 1957.
- 51990 F700EF (vertical dip, Export). 12v.; double contact; C.P.R.; die cast.  
Commer 'Cob' 1958-59.  
Hillman 'Minx Special' and 'Husky' 1958-59.  
Singer 'Gazelle' 1957.
- 51991 F700. 12v.; double contact; C.P.R.; less light unit and bulb.  
Commer 'Cob' 1958-60.  
Hillman 'Minx Special' 1958-59; 'Husky' Series I 1958-60.
- 51999 F700EF (vertical dip, Export). 12v.; double contact; C.P.R.; to take 3-pin bulb.  
Nash 'Metropolitan' 1956-57.
- 55043 FFT462. 12v.; single contact; C.P.R.  
Leonard Gundle 1951-55.
- 58006 F700 (dip left). 12v.; double contact; C.P.R.; peaked.  
Morris 'Oxford' 1957-59; 'Traveller' and 'Hindustan' 1957-60.  
Riley 'Two-Point-Six' 1958-59.
- 58007 F700 (dip right, Export). 12v.; double contact; C.P.R.; peaked.  
Morris 'Oxford' 1957-59; 'Traveller' and 'Hindustan' 1957-60.  
Riley 'Two-Point-Six' 1958-59.
- 58008 F700 (vertical dip, Export). 12v.; double contact; C.P.R.; peaked.  
Morris 'Oxford' 1957-59; 'Traveller' and 'Hindustan' 1957-60.  
Riley 'Two-Point-Six' 1958-59.
- 58009 F700EF (vertical dip, Export). 12v.; double contact; C.P.R.; peaked; to take 3-pin bulb; less bulb.  
Morris 'Oxford', 'Traveller' and 'Hindustan' 1957-59.  
Riley 'Two-Point-Six' 1958-59.
- 58010 F700 (dip right, Export). 12v.; double contact; C.P.R.; peaked.  
Morris 'Oxford' 1958-59; 'Traveller' and 'Hindustan' 1958-60.  
Riley 'Two-Point-Six' 1958-59.
- 58011 F700 (Export). 12v.; double contact; C.P.R.; peaked; less light unit and bulb.  
Morris 'Oxford' 1957-59; 'Traveller' and 'Hindustan' 1957-60.  
Riley 'Two-Point-Six' 1958-59.
- 58022 F700EF (vertical dip, Export). 12v.; double contact; C.P.R.; to take 3-pin bulb.  
Rolls-Royce 'Silver Cloud' 1956-59.
- 58023 F700EF (vertical dip, Export). 12v.; double contact; C.P.R.; to take 3-pin bulb.  
Bentley Model 'S' 1957-59; 'Continental' Sports 1955-59.
- 58034 F700 (dip left). 12v.; double contact; C.P.R.  
Bedford TD 1958.
- 58035 F700 (dip right, Export). 12v.; double contact; C.P.R.  
Bedford TD 1958.
- 58036 F700 (vertical dip, Export). 12v.; double contact; C.P.R.  
Bedford TD 1958.
- 58038 F700 (Export). 12v.; double contact; C.P.R.; to take Bosch cap bulb; less bulb.  
Standard 8 and 10 1958-59; 'Companion' Estate Car, 6 cwt. Van and Pick-up Truck 1958-59; 'Pennant' 1959; 'Atlas' Van and Pick-up Truck 1959.
- 58041 F700 (dip left). 12v.; double contact; steel primer rim.  
Standard 'Vanguard' 1957-58.
- 58042 F700 (dip right, Export). 12v.; double contact; steel primer rim.  
Standard 'Vanguard' 1957-58.
- 58043 F700 (vertical dip, Export). 12v.; double contact; steel primer rim.  
Standard 'Vanguard' 1958.
- 58044 F700 (vertical dip, Export). 12v.; double contact; steel primer rim.  
Standard 'Vanguard' 1957-58.
- 58045 F700EF (vertical dip, Export). 12v.; double contact; to take 3-pin bulb; less bulb.  
Standard 'Vanguard' 1957-58.
- 58046 F700 (vertical dip, Export). 12v.; double contact; steel primer rim.  
Standard 'Vanguard' 1957-58.
- 58047 F700 (dip right, Export). 12v.; double contact; steel primer rim.  
Standard 'Vanguard' 1957-58.
- 58048 F700 (dip left). 12v.; double contact; C.P.R.; peaked.  
Austin A55, A90, A95 and A105 (BS7) 1958-59.
- 58049 F700 (dip right, Export). 12v.; double contact; C.P.R.; peaked.  
Austin A55, A90, A95 and A105 1958-59.
- 58050 F700 (vertical dip, Export). 12v.; double contact; C.P.R.; peaked.  
Austin A55, A90, A95 and A105 (BS7) 1958-59.

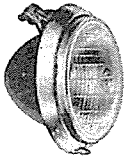

# HEADLAMPS

## VEHICLE APPLICATION REFERENCE—continued

- 58051 F700EF (vertical dip, Export). 12v.; double contact; C.P.R.; peaked; to take 3-pin bulb; less bulb.  
Austin A55, A90, A95 and A105 (BS7) 1958-59.
- 58056 F700 (dip left). 12v.; double contact; C.P.R.  
Austin A55 Pick-up Truck, Chassis and Van 1958-60.
- 58057 F700 (dip right, Export). 12v.; double contact; C.P.R.  
Austin A55 Pick-up Truck, Chassis and Van 1958-60.
- 58058 F700 (vertical dip, Export). 12v.; double contact; C.P.R.  
Austin A55 Pick-up Truck, Chassis and Van 1958-59.
- 58059 F700EF (vertical dip, Export). 12v.; double contact; C.P.R.; to take 3-pin bulb; less bulb.  
Austin A55 Pick-up Truck, Chassis and Van 1958-59.
- 58078 F700 (dip left, Export). 12v.; double contact; C.P.R.  
Wolseley 'Fifteen Hundred' 1958-59.
- 58083 F700 (dip left). 12v.; double contact; C.P.R.  
Austin 'Metropolitan' 1957-60.
- 58084 F700 (vertical dip, Export). 12v.; double contact; C.P.R.  
Austin 'Metropolitan' 1957-59.
- 58085 F700EF (vertical dip, Export). 12v.; double contact; C.P.R.; to take 3-pin bulb; less bulb.  
Austin 'Metropolitan' 1957-59.
- 58086 F700 (dip right, Export). 12v.; double contact; C.P.R.  
Austin 'Metropolitan' 1957-60.
- 58087 F700 (dip left). 12v.; double contact; C.P.R.; peaked.  
Riley 'Two-Point-Six' 1958-59.
- 58099 F700 (dip left, Export). 12v.; double contact; C.P.R.; peaked.  
Riley 'One-Point-Five' 1958-60.
- 58100 F700 (dip right, Export). 12v.; double contact; C.P.R.; peaked.  
Riley 'One-Point-Five' 1958-60.
- 58101 F700 (dip left). 12v.; double contact; C.P.R.; peaked.  
Riley 'One-Point-Five' 1958-60.
- 58107 F700 (dip left). 12v.; double contact; primer rim; peaked; chrome edge.  
Sunbeam 'Rapier' 1958-60.
- 58110 PF700 (vertical dip). 12v.; double contact; C.P.R.  
Aston Martin DB Mk. III 1958-59; DB4 1959-60.
- 58119 MCF575P (dip left). 12v.; double contact; C.P.R.; with pilot light; less body.  
Isetta '300' 1957-58.
- 58121 F700 (vertical dip, Export). 12v.; double contact; C.P.R.  
Wolseley 'Fifteen Hundred' 1958-59.
- 58128 F700 (dip left). 12v.; double contact; steel primer rim.  
Standard 'Ensign' 1958-60.
- 58129 F700 (dip right). 12v.; double contact; steel primer rim.  
Standard 'Ensign' 1958-60.
- 58130 F700 (vertical dip, Export). 12v.; double contact; steel primer rim.  
Standard 'Ensign' 1958-60.
- 58131 F700 (vertical dip, Export). 12v.; double contact; steel primer rim.  
Standard 'Ensign' 1958-60.
- 58132 F700EF (vertical dip, Export). 12v.; double contact; steel primer rim; to take 3-pin bulb; less bulb.  
Standard 'Ensign' 1958-60.
- 58133 F700 (vertical dip, Export). 12v.; double contact; steel primer rim.  
Standard 'Ensign' 1958-60.
- 58134 F700 (dip right, Export). 12v.; double contact; steel primer rim.  
Standard 'Ensign' 1958.
- 58139 F700 (vertical dip, Export). 12v.; double contact; primer rim; chrome edge.  
Sunbeam 'Rapier' 1958-59.
- 58140 F700EF (vertical dip, Export). 12v.; double contact; primer rim; chrome edge; to take 3-pin bulb; less bulb.  
Sunbeam 'Rapier' 1958-59.
- 58141 F700 (Export). 12v.; double contact; primer rim; chrome edge; less light unit.  
Sunbeam 'Rapier' 1958-59.
- 58142 F700 (dip left). 12v.; double contact; C.P.R.  
Rover 3 litre 1959-60.
- 58143 F700 (dip left). 12v.; double contact; C.P.R.; peaked.  
Riley 'One-Point-Five' 1958-60.
- 58144 F700 (vertical dip, Export). 12v.; double contact; C.P.R.; peaked.  
Riley 'One-Point-Five' 1958-59.
- 58145 F700EF (vertical dip, Export). 12v.; double contact; C.P.R.; peaked; to take 3-pin bulb; less bulb.  
Riley 'One-Point-Five' 1958-59.
- 58146 F700 (Export). 12v.; double contact; C.P.R.; peaked; less light unit.  
Riley 'One-Point-Five' 1958-59.
- 58148 F700VF (dip right, Export). 12v.; double contact; C.P.R.  
Isetta '300' 1957-60.
- 58164 PF700 (dip left, Export). 12v.; double contact; C.P.R.  
Austin 'Princess' 1958-60; Ambulance and Hearse 1959-60.
- 58165 PF700 (dip left). 12v.; double contact; C.P.R.  
Austin 'Princess' 1958-60; Ambulance and Hearse 1960.
- 58166 PF700 (dip right, Export). 12v.; double contact; C.P.R.  
Austin 'Princess' 1958-60; Ambulance and Hearse 1959-60.
- 58175 F700 (dip left). 12v.; double contact; C.P.R.; peaked.  
Humber 'Super Snipe' 1959.
- 58176 F700 (Export). 12v.; double contact; less light unit, adaptor and rim.  
Alfa Romeo 'Giulietta' and T10 Van 1958-60.
- 58181 P700 (dip left). 12v.; double contact; C.P.R.  
Peerless 1959-60.  
Triumph TR3 1959-60.
- 58182 F700 (dip left). 12v.; double contact; C.P.R.  
Singer 'Gazelle' 1958-59.
- 58188 F700 (dip left). 12v.; double contact; C.P.R.  
Triumph TR3 1958.
- 58189 PF700. 12v.; double contact; C.P.R.; less light unit.  
Armstrong Siddeley 'Sapphire' 1959-60; 'Star' Limousine 1960.  
Aston Martin DB Mk. III 1958-59.
- 58190 F700P (dip right, Export). 12v.; double contact; C.P.R.; with pilot light.  
Fairthorpe All Models 1958-60.
- 58203 F700 (vertical dip, Export). 12v.; double contact; C.P.R.  
Triumph TR3 1958.
- 58218 F700 (dip left). 12v.; double contact; C.P.R. (combined head and side lamp rim).  
Austin A40 1959-60.
- 58219 F700 (dip right, Export). 12v.; double contact; C.P.R. (combined head and side lamp rim).  
Austin A40 1959-60.
- 58220 F700 (vertical dip, Export). 12v.; double contact; C.P.R. (combined head and side lamp rim).  
Austin A40 1959.
- 58225 F700 (dip left). 12v.; double contact; C.P.R.  
Jaguar 2.4, 3.4 and 3.8 litre 1959-60.
- 58226 F700 (dip right, Export). 12v.; double contact; C.P.R.  
Jaguar 2.4, 3.4 and 3.8 litre 1959-60.
- 58230 F700 (vertical dip, Export). 12v.; double contact; C.P.R.  
Alvis TD21 1958-60.  
Austin 'Seven' (850) and A35 1959-60; Taxi and Hire Car 1959-60.  
Bedford CA Van (later) 1960; TC and TJ (later) 1960.  
Commer  $\frac{3}{4}$  1 $\frac{1}{2}$ , 2, 3, 5 and 6 ton 'Superpoise' Models 1959-60; 1, 1 $\frac{1}{4}$  1 $\frac{1}{2}$ , 4, 5, 6 and 7 ton Forward Control, 10/12 ton Tractor, Fire Tender and 'Avenger' Coach 1959-60.  
Jaguar 2.4, 3.4 and 3.8 litre 1959-60.  
Karrier 'Gamecock' and 1 $\frac{1}{4}$  1 $\frac{1}{2}$  ton Passenger 1959-60.  
Morgan 'Plus Four' and 'Four Four' 1959-60.  
Morris 'Mini-minor' 1959-60; 'Minor' and Quarter Ton Van (later) 1960.  
Vauxhall All Models (except 'Victor' and 'Envoy') (later) 1960.
- 58231 F700 (vertical dip, Export). 12v.; double contact; C.P.R.  
Alvis TD21 1958-60.  
Austin 'Seven' (850), A35, Taxi and Hire Car 1959-60.  
Bedford CA Van, TC and TJ 1960.  
Commer  $\frac{3}{4}$  1 $\frac{1}{2}$ , 2, 3, 5 and 6 ton 'Superpoise' Models, 1, 1 $\frac{1}{4}$  1 $\frac{1}{2}$ , 4, 5, 6 and 7 ton Forward Control, 10/12 ton Tractor, 'Avenger' Coach and Fire Tender 1960.  
Jaguar 2.4, 3.4 and 3.8 litre (later) 1960.  
Karrier 'Gamecock' and 1 $\frac{1}{4}$  1 $\frac{1}{2}$  ton Passenger 1960.  
Morris 'Mini-minor' 1959-60; 'Minor' and Quarter Ton Van (later) 1960.  
Vauxhall All Models (except 'Victor' and 'Envoy') 1960.
- 58235 F700 (dip left). 12v.; double contact; C.P.R.; peaked.  
Austin A105 (BS8) 1958-59.
- 58236 F700 (vertical dip, Export). 12v.; double contact; C.P.R.; peaked.  
Austin A105 (BS8) 1958-59.
- 58237 F700EF (vertical dip, Export). 12v.; double contact; C.P.R.; peaked; to take 3-pin bulb; less bulb.  
Austin A105 (BS8) 1958-59.
- 58240 F700 (Export). 12v.; double contact; steel primer rim; less light unit.  
Standard 'Ensign' 1959-60.
- 58247 F700P (dip left). 12v.; double contact; C.P.R.; with pilot light.  
Fairthorpe All Models 1958-60.
- 58250 F700 (Export). 12v.; double contact; less light unit and rim.  
Simca-Aronde 'Chatelaine' Station Wagon 1959.  
Simca-Vedette 'Beaulieu' and 'Chambord' 1959.
- 58251 F700 (dip left). 12v.; double contact; C.P.R.; peaked.  
Austin A55 Mk. II 1959-60.  
M.G. 'Magnette' Mk. III 1959-60.  
Morris 'Oxford' 1959-60.  
Riley 'Four Sixty-Eight' 1959-60.  
Wolseley 'Fifteen Sixty' 1959-60.
- 58252 F700 (dip right, Export). 12v.; double contact; C.P.R.; peaked.  
Austin A55 Mk. II 1959-60.  
M.G. 'Magnette' Mk. III 1959-60.  
Morris 'Oxford' 1959-60.  
Riley 'Four Sixty-Eight' 1959-60.  
Wolseley 'Fifteen Sixty' 1959-60.
- 58253 F700 (vertical dip, Export). 12v.; double contact; C.P.R.; peaked.  
Austin A55 Mk. II 1959-60.  
M.G. 'Magnette' Mk. III 1959-60.  
Morris 'Oxford' 1959-60.  
Riley 'Four Sixty-Eight' 1959-60.  
Wolseley 'Fifteen Sixty' 1959-60.
- 58254 F700 (vertical dip, Export). 12v.; double contact; C.P.R.; peaked.  
Austin A55 Mk. II 1959-60.  
M.G. 'Magnette' Mk. III 1959-60.  
Morris 'Oxford' 1959-60.  
Riley 'Four Sixty-Eight' 1959-60.  
Wolseley 'Fifteen Sixty' 1959-60.
- 58255 F700 (Export). 12v.; double contact; C.P.R.; peaked; less light unit.  
M.G. 'Magnette' Mk. III 1959.  
Morris 'Oxford' 1959.  
Riley 'Four Sixty-Eight' 1959.  
Wolseley 'Fifteen Sixty' 1959.

# HEADLAMPS

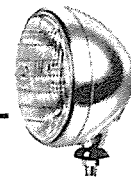

## VEHICLE APPLICATION REFERENCE—continued

- 58260 F700 (dip left). 12v.; double contact; C.P.R.  
Daimler SP250 1960.  
Lotus 'Elite' 1959-60.  
Triumph TR3 1959-60.
- 58261 F700EF (vertical dip, Export). 12v.; double contact; C.P.R.; to take 3-pin bulb; less bulb.  
Triumph TR3 1959-60.
- 58262 F700 (Export). 12v.; double contact; C.P.R.; less light unit.  
Peerless 1959-60.
- 58263 F700 (dip right, Export). 12v.; double contact; C.P.R.  
Lotus 'Elite' 1960.  
Peerless 1959-60.  
Triumph TR3 1959-60.
- 58264 F700 (vertical dip, Export). 12v.; double contact; C.P.R.  
Triumph TR3 1959-60.
- 58265 F700 (vertical dip, Export). 12v.; double contact; C.P.R.  
Peerless 1959-60.  
Triumph TR3 1959-60.
- 58266 F700 (vertical dip, Export). 12v.; double contact; C.P.R.  
Triumph TR3 1959-60.
- 58267 F700P (dip left). 12v.; double contact; C.P.R.; with pilot light.  
Frisky 1958-60.
- 58268 F700 (vertical dip, Export). 12v.; double contact; C.P.R.  
Morris 'Oxford' (later) 1959; 'Traveller' and 'Hindustan' 1959-60.  
Riley 'Two-Point-Six' (later) 1959.
- 58269 F700EF (vertical dip, Export). 12v.; double contact; C.P.R.  
Morris 'Oxford' (later) 1959; 'Traveller' and 'Hindustan' 1959-60.  
Riley 'Two-Point-Six' (later) 1959.
- 58270 F700 (vertical dip, Export). 12v.; double contact; C.P.R.  
Commer 'Express' Delivery Van and Pick-up Truck 1959-60;  $\frac{1}{2}$  ton Forward Control 1960.  
Morris 'Minor' and Quarter and Half Ton Vans 1959-60.  
Wolseley 'Six Ninety' (later) 1959.
- 58271 F700EF (vertical dip, Export). 12v.; double contact; C.P.R.  
Commer 'Express' Delivery Van and Pick-up Truck 1959-60;  $\frac{1}{2}$  ton Forward Control 1960.  
Morris 'Minor' and Quarter and Half Ton Vans 1959-60.  
Wolseley 'Six Ninety' (later) 1959.
- 58272 F700 (vertical dip, Export). 12v.; double contact; C.P.R.  
Austin 152 and 301 ranges (except 301FC) 1959-60.  
M.G. MGA 1959-60; 'Magnette' (later) 1959.  
Morris Commercial LC5, LCO5 and 'J2' 1959-60.  
Wolseley 'Fifteen Fifty' (later) 1959.
- 58273 F700 (vertical dip, Export). 12v.; double contact; C.P.R.  
Austin 152 and 301 ranges (except 301FC) 1959-60.  
M.G. MGA 1959-60; 'Magnette' (later) 1959.  
Morris Commercial LC5, LCO5 and 'J2' Light Van, Pick-up Truck and 'Minibus' 1959-60.  
Wolseley 'Fifteen Fifty' (later) 1959.
- 58274 F700 (vertical dip, Export). 12v.; double contact; C.P.R.  
Austin 301FC 1959; 3, 4 and 5 ton (later) 1959; 3 ton (303), 4 ton (403) and 5 ton (503) 1960; LD Models and 5 ton (504) 1959-60.  
Morris Commercial LD Models 1959-60; LCFO (later) 1959.
- 58275 F700 (vertical dip, Export). 12v.; double contact; C.P.R.  
Austin 301FC 1959; 3, 4 and 5 ton (later) 1959; 3 ton (303), 4 ton (403) and 5 ton (503) 1960; LD Models and 5 ton (504) 1959-60.  
Morris Commercial LD Models 1959-60; LCFO (later) 1959.
- 58276 F700 (vertical dip, Export). 12v.; double contact; C.P.R.; peaked.  
Riley 'One-Point-Five' 1959-60.
- 58277 F700EF (vertical dip, Export). 12v.; double contact; C.P.R.; peaked.  
Riley 'One-Point-Five' 1959-60.
- 58278 F700 (vertical dip, Export). 12v.; double contact; C.P.R. (combined head and side lamp rim).  
Austin A40 1959-60.
- 58279 F700EF (vertical dip, Export). 12v.; double contact; C.P.R. (combined head and side lamp rim).  
Austin A40 1959-60.
- 58280 F700 (vertical dip, Export). 12v.; double contact; C.P.R.; peaked.  
Austin A55, A90, A95 and A105 (BS7) (later) 1959.
- 58281 F700 (vertical dip, Export). 12v.; double contact; C.P.R.; peaked.  
Austin A55, A90, A95 and A105 (BS7) (later) 1959.
- 58282 F700 (vertical dip, Export). 12v.; double contact; C.P.R.  
Austin A55 Pick-up Truck, Chassis and Van 1959-60.
- 58283 F700EF (vertical dip, Export). 12v.; double contact; C.P.R.  
Austin A55 Pick-up Truck, Chassis and Van 1959-60.
- 58286 F700 (vertical dip, Export). 12v.; double contact; C.P.R.  
Austin 7 ton, 'Gipsy' and Coach 1959-60; Series IVFG Trucks 1960; Austin-Healey 'Sprite' 1959-60.  
Morris Commercial Coach (later) 1959; Series III and Series IVFF Trucks 1959-60; Series IVFG Trucks 1960.  
Rover '60', '75', '90', '105' and 'Landrover' 1959; '80' and '100' 1960.  
Wolseley 'Fifteen Hundred' 1960.
- 58287 F700EF (vertical dip, Export). 12v.; double contact; C.P.R.  
Austin Series IVFG Trucks 1960; 7 ton, Coach and 'Gipsy' 1959-60; Austin-Healey 'Sprite' 1959-60.  
Morris Commercial Series III and IVFF Trucks 1959-60; Coach (later) 1959; Series IVFG 1960.  
Rover '60', '75', '90' and '105' (later) 1959; '80' and '100' 1960; 'Landrover' 1959-60.  
Wolseley 'Fifteen Hundred' 1960.
- 58288 F700 (vertical dip, Export). 12v.; double contact; C.P.R.  
Austin 'Metropolitan' 1959-60.
- 58289 F700EF (vertical dip, Export). 12v.; double contact; C.P.R.  
Austin 'Metropolitan' 1959-60.
- 58290 F700 (vertical dip, Export). 12v.; double contact; C.P.R.  
Austin-Healey '100 Six' (later) 1959; '3000' 1959-60.
- 58291 F700EF (vertical dip, Export). 12v.; double contact; C.P.R.  
Austin-Healey '100 Six' (later) 1959; '3000' 1959-60.
- 58293 PF700 (vertical dip, Export). 12v.; double contact; C.P.R.  
Jaguar Mk. VIII, Mk. IX and XK150 1959-60.
- 58295 S700 (vertical dip, Export). 12v.; double contact; E.B., C.P.R. finish; upright fixing.  
Austin 101 Van 1959-60.  
Morris Commercial 'JB' Van 1959-60.
- 58301 PF770 (dip left). 12v.; double contact; C.P.R.  
Armstrong Siddeley 'Star Sapphire' 1959.
- 58304 PF700 (dip left). 12v.; double contact; C.P.R.  
Armstrong Siddeley 'Star Sapphire' 1959-60; 'Star' Limousine 1960.
- 58305 PF700 (vertical dip). 12v.; double contact; C.P.R.  
Armstrong Siddeley 'Star Sapphire' 1959-60; 'Star' Limousine 1960.
- 58306 PF700EF (vertical dip, Export). 12v.; double contact; C.P.R.  
Armstrong Siddeley 'Star Sapphire' 1959-60; 'Star' Limousine 1960.
- 58307 PF700 (vertical dip). 12v.; double contact; C.P.R.  
Armstrong Siddeley 'Star Sapphire' 1959-60.
- 58308 PF700 (dip right, Export). 12v.; double contact; C.P.R.  
Armstrong Siddeley 'Star Sapphire' 1959-60.
- 58315 F700 (vertical dip, Export). 12v.; double contact; C.P.R.; peaked.  
Austin A55 Mk. II 1959.  
M.G. 'Magnette' Mk. III 1959.  
Morris 'Oxford' 1959.  
Riley 'Four Sixty-Eight' 1959.  
Wolseley 'Fifteen Sixty' 1959.
- 58319 F700 (dip left). 12v.; double contact; C.P.R.; peaked.  
Triumph 'Herald' 1959-60.
- 58327 F700 (dip right, Export). 12v.; double contact; C.P.R.; peaked.  
Triumph 'Herald' 1959-60.
- 58329 F700EF (vertical dip, Export). 12v.; double contact; C.P.R.; peaked; to take 3-pin bulb; less bulb.  
Triumph 'Herald' 1959-60.
- 58330 F700 (vertical dip, Export). 12v.; double contact; C.P.R.; peaked.  
Triumph 'Herald' 1959-60.
- 58331 F700 (vertical dip, Export). 12v.; double contact; C.P.R.; peaked.  
Triumph 'Herald' 1959-60.
- 58332 F700 (vertical dip, Export). 12v.; double contact; C.P.R.; peaked.  
Triumph 'Herald' 1959-60.
- 58334 RL700 (dip left). 12v.; double contact; C.P.R.  
Bentley 'S2' and 'Continental' Sports 1960.  
Rolls-Royce 'Silver Cloud' 1959-60; 'Phantom' 1960.
- 58336 PL700 (dip left). 12v.; double contact; C.P.R.  
Alvis TD21 1958-60.
- 58340 F700 (vertical dip, Export). 12v.; double contact; C.P.R.  
Karrier 'Bantam' 1960.
- 58341 F700 (vertical dip, Export). 12v.; double contact; C.P.R.  
Rover 3 litre 1959-60.
- 58342 F700EF (vertical dip, Export). 12v.; double contact; C.P.R.  
Rover 3 litre 1959-60.
- 58343 F700 (Export). 12v.; double contact; C.P.R.; less light unit.  
Rover 3 litre 1959-60.
- 58344 PL700 (dip right, Export). 12v.; double contact; C.P.R.  
Rover 3 litre 1959-60.
- 58359 F700 (vertical dip, Export). 12v.; double contact; C.P.R.; peaked.  
Commer 'Cob' Series II 1960.  
Hillman 'Minx' (later) 1959; 'Husky' Series II 1960.
- 58360 F700EF (vertical dip, Export). 12v.; double contact; C.P.R.; peaked.  
Commer 'Cob' Series II 1960.  
Hillman 'Minx' (later) 1959; 'Husky' Series II 1960.
- 58361 F700 (vertical dip, Export). 12v.; double contact; primer rim with chrome edge.  
Singer 'Gazelle' 1959-60.  
Sunbeam 'Rapier' 1959-60.
- 58362 F700EF (vertical dip, Export). 12v.; double contact; primer rim with chrome edge.  
Jaguar XK150 1960.  
Singer 'Gazelle' 1959-60.  
Sunbeam 'Rapier' 1959-60.
- 58363 F700 (vertical dip, Export). 12v.; double contact; C.P.R.  
Singer 'Gazelle' (later) 1959.
- 58364 F700EF (vertical dip, Export). 12v.; double contact; C.P.R.  
Singer 'Gazelle' (later) 1959.
- 58365 F700 (vertical dip, Export). 12v.; double contact; C.P.R.  
Commer 'Cob' 1959-60.  
Hillman 'Minx Special' (later) 1959; 'Husky' Series I 1959-60.
- 58366 F700EF (vertical dip, Export). 12v.; double contact; C.P.R.  
Commer 'Cob' 1959-60.  
Hillman 'Minx Special' (later) 1959; 'Husky' Series I 1959-60.



# HEADLAMPS

## VEHICLE APPLICATION REFERENCE—continued

- 58369 F700 (vertical dip, Export). 12v.; double contact; C.P.R.; peaked.  
Humber 'Hawk' and 'Super Snipe' 1959-60.
- 58370 F700EF (vertical dip, Export). 12v.; double contact; C.P.R.; peaked.  
Humber 'Hawk' and 'Super Snipe' 1959-60.
- 58388 F700P (dip left). 12v.; double contact; C.P.R.; with pilot light.  
Austin 'Seven' (850) 1959-60.  
Morris 'Mini-minor' 1959-60.
- 58390 PF700 (dip left). 12v.; double contact; C.P.R.  
Armstrong Siddeley 'Star Sapphire' and Limousine 1960.
- 58400 F700 (dip left). 12v.; double contact; C.P.R.  
Bond 'Minicar' 1959-60.
- 58402 F700 (Export). 12v.; double contact; C.P.R.; less light unit.  
Standard 'Vanguard' 1959-60.
- 58403 F700 (dip left). 12v.; double contact; primer rim; peaked.  
Sunbeam 'Alpine' 1959-60.
- 58405 F700EF (vertical dip, Export). 12v.; double contact; primer rim; peaked.  
Hillman 'Minx' 1959-60.  
Sunbeam 'Alpine' 1959-60.
- 58406 F700 (vertical dip, Export). 12v.; double contact; primer rim; peaked.  
Hillman 'Minx' 1959-60.  
Sunbeam 'Alpine' 1959-60.
- 58407 F700 (Export). 12v.; double contact; primer rim; peaked; less light unit.  
Sunbeam 'Alpine' 1959.
- 58412 F700 (Export). 12v.; double contact; C.P.R.; less light unit.  
Standard 'Companion' Estate Car, 6 cwt. Van and Pick-up Truck 1960.  
Triumph TR3 1959-60.
- 58415 F700VF (dip left). 12v.; double contact; C.P.R.; less body.  
Isetta '300' 1959-60.
- 58433 F700 (dip left). 12v.; double contact; primer rim; peaked.  
Vauxhall 'Victor' 1958-60.
- 58434 F700 (dip right, Export). 12v.; double contact; primer rim; peaked.  
Vauxhall 'Victor' 1958-60.
- 58435 F700 (vertical dip, Export). 12v.; double contact; primer rim; peaked.  
Vauxhall 'Victor' 1958-60.
- 58436 F700 (vertical dip, Export). 12v.; double contact; primer rim; peaked.  
Vauxhall 'Victor' 1958-60.
- 58437 F700EF (vertical dip, Export). 12v.; double contact; primer rim; peaked.  
Vauxhall 'Victor' (later) 1960.
- 58438 F700 (vertical dip). 12v.; double contact; primer rim; peaked.  
Vauxhall 'Victor' (later) 1960.
- 58440 F700 (Export). 12v.; double contact; primer rim; peaked; less light unit.  
Vauxhall 'Victor' and 'Envoy' 1958-60.
- 58443 F700 (dip left). 12v.; double contact; C.P.R.; peaked.  
Wolseley 'Six Ninety-Nine' 1959-60.
- 58444 F700 (dip right, Export). 12v.; double contact; C.P.R.; peaked.  
Austin 3 litre 'Princess' 1960.  
Wolseley 'Six Ninety-Nine' 1959-60.
- 58445 F700 (vertical dip, Export). 12v.; double contact; C.P.R.; peaked.  
Austin 3 litre 'Princess' 1960.  
Wolseley 'Six Ninety-Nine' 1959-60.
- 58446 F700 (vertical dip, Export). 12v.; double contact; C.P.R.; peaked.  
Austin A55 Mk. II 1959-60; 3 litre 'Princess' 1960  
M.G. 'Magnette' Mk. III 1959-60.  
Morris 'Oxford' 1959-60.  
Riley 'Four Sixty-Eight' 1959-60.  
Wolseley 'Six Ninety-Nine' and 'Fifteen Sixty' 1959-60.
- 58447 F700EF (vertical dip, Export). 12v.; double contact; C.P.R.; peaked.  
Austin 3 litre 'Princess' 1960.  
Wolseley 'Six Ninety-Nine' 1959-60.
- 58450 F700 (vertical dip, Export). 12v.; double contact; C.P.R.  
Jaguar 2.4, 3.4 and 3.8 litre (later) 1960.  
Morris 'Minor' and Quarter and Half Ton Vans 1959-60.
- 58451 F700 (vertical dip, Export). 12v.; double contact; C.P.R.  
Austin 301FC 1959; LD Models 152 and 301 Ranges (except 301FC) 1959-60.  
M.G. MGA 1959-60.  
Morris Commercial LC5 and LCO5 1960; 'J2' 1959-60.
- 58452 F700 (vertical dip, Export). 12v.; double contact; C.P.R.  
Austin 3, 4 and 5 ton 1959-60; 5 ton (504) (later) 1960.  
Morris Commercial LD Models 1959-60; LCFO 1959.
- 58453 F700 (vertical dip, Export). 12v.; double contact; C.P.R.; peaked.  
Riley 'One-Point-Five' 1959-60.
- 58454 F700 (vertical dip, Export). 12v.; double contact; C.P.R.; peaked.  
Riley 'Two-Point-Six' 1959.
- 58455 F700 (vertical dip). 12v.; double contact; C.P.R. (combined head and side lamp rim).  
Austin A40 1959-60.
- 58456 F700 (vertical dip, Export). 12v.; double contact; C.P.R.  
Austin 'Seven' (850) and A35 1959-60; Taxi and Hire Car 1959-60.  
Morris 'Minor' (later) 1960; 'Mini-minor' 1959-60.
- 58457 F700 (vertical dip, Export). 12v.; double contact; C.P.R.  
Austin A55 1959; A55 Pick-up Truck, Chassis and Van 1959-60.
- 58458 F700 (vertical dip, Export). 12v.; double contact; C.P.R.  
Austin 'Metropolitan' 1959-60.
- 58459 F700 (vertical dip, Export). 12v.; double contact; C.P.R.  
Austin 7 ton and Coach 1959-60; Series IVFG Trucks and 'Gipsy' (later) 1960; Austin-Healey 'Sprite' 1959-60.  
Morris Commercial Series III Trucks and Series IVFG Trucks (later) 1960.  
Rover '80' and '100' 1960; 'Landrover' 1959.  
Wolseley 'Fifteen Hundred' 1960.
- 58460 F700 (vertical dip, Export). 12v.; double contact; C.P.R. (combined head and side lamp rim).  
Austin A99 1959-60.
- 58462 PF700 (vertical dip, Export). 12v.; double contact; C.P.R.  
Austin 'Princess' Mk. IV 1959.
- 58463 F700 (vertical dip, Export). 12v.; double contact; C.P.R.  
Austin-Healey '100 Six' 1959; '3000' 1959-60.
- 58464 S700 (vertical dip, Export). 12v.; double contact; E.B., C.P.R. finish; upright fixing.  
Austin '101 Van' 1959-60.  
Morris Commercial 'JB' Van 1959-60.
- 58465 F700 (dip left). 12v.; double contact; C.P.R. (combined head and side lamp rim).  
Austin A99 1959-60.
- 58466 F700 (dip right, Export). 12v.; double contact; C.P.R. (combined head and side lamp rim).  
Austin A99 1959-60.
- 58467 F700 (vertical dip, Export). 12v.; double contact; C.P.R. (combined head and side lamp rim).  
Austin A99 1959-60.
- 58468 F700EF (vertical dip, Export). 12v.; double contact; C.P.R. (combined head and side lamp rim).  
Austin A99 1959-60.
- 58469 F700 (Export). 12v.; double contact; C.P.R.; peaked; less light unit.  
Triumph 'Herald' 1959-60.
- 58486 PL700 (dip left). 12v.; double contact; C.P.R.; peaked.  
Humber 'Super Snipe' 1960.
- 58491 F700 (Export). 12v.; double contact; primer rim with C.P. edge; less light unit.  
Singer 'Gazelle' 1959-60.  
Sunbeam 'Rapier' 1959-60.
- 58492 F700 (Export). 12v.; double contact; C.P.R.; peaked; less light unit.  
Humber 'Hawk' and 'Super Snipe' (later) 1960.
- 58493 F700 (Export). 12v.; double contact; C.P.R.; less light unit.  
Austin 'Seven' (850) and A35 1959-60.  
Commer 'Express' Delivery Van and Pick-up Truck (later) 1960; 7 ton Forward Control 1960.  
Jaguar 2.4, 3.4 and 3.8 litre 1960.  
Layton Sports Car 'Jomar' 1959.  
Morris 'Minor' and Quarter Ton Van 1960; 'Mini-minor' 1959-60.
- 58541 F700 (vertical dip, Export). 12v.; double contact; C.P.R.  
Bentley 'Continental' Sports and 'S2' Model 1960.  
Rolls-Royce 'Silver Cloud' and 'Phantom' 1960.
- 58542 RL700EF (vertical dip, Export). 12v.; double contact; C.P.R.  
Bentley 'Continental' Sports and 'S2' Model 1960.  
Rolls-Royce 'Silver Cloud' and 'Phantom' 1960.
- 58543 F700 (vertical dip). 12v.; double contact; C.P.R.  
Bentley 'Continental' Sports and 'S2' Model 1960.  
Rolls-Royce 'Silver Cloud' and 'Phantom' 1960.
- 58548 F700 (dip left). 12v.; double contact; primer rim; peaked.  
Hillman 'Minx' 1959-60.
- 58549 F700 (Export). 12v.; double contact; primer rim; peaked; less light unit.  
Hillman 'Minx' 1959-60.  
Sunbeam 'Alpine' 1960.
- 58550 F700 (dip left). 12v.; double contact; primer rim with C.P. edge.  
Singer 'Gazelle' 1959-60.
- 58553 F700 (Export). 12v.; double contact; C.P.R.; less light unit.  
Bentley 'Continental' Sports and 'S2' Model 1960  
Rolls-Royce 'Silver Cloud' and 'Phantom' 1960.
- 58560 F700 (vertical dip, Export). 12v.; double contact; C.P.R.  
Daimler SP250 1960.  
Lotus 'Elite' 1959-60.
- 58561 F700EF (vertical dip, Export). 12v.; double contact; C.P.R.  
Daimler SP250 1960.  
Lotus 'Elite' 1959-60.
- 58563 F700 (Export). 12v.; double contact; C.P.R.; less light unit.  
Austin-Healey 'Sprite' 1960.  
Rover '80' and '100' 1960; 'Landrover' (later) 1960.  
Wolseley 'Fifteen Hundred' 1960.
- 58564 F700 (Export). 12v.; double contact; C.P.R.; less light unit.  
Rover 3 litre (later) 1960.
- 58566 F700 (Export). 12v.; double contact; C.P.R.; peaked; less light unit.  
Austin A55 Mk. II 1959-60.  
M.G. 'Magnette' Mk. III 1960.  
Morris 'Oxford' 1960.  
Riley 'Four Sixty-Eight' 1960.  
Wolseley 'Fifteen Sixty' 1960.
- 58567 F700. 12v.; double contact; C.P.R. (combined head and side lamp rim); less light unit.  
Austin A99 1959-60.
- 58568 F700 (Export). 12v.; double contact; C.P.R.; peaked; less light unit.  
Riley 'One-Point-Five' 1960.
- 58569 F700 (Export). 12v.; double contact; C.P.R.; less light unit.  
Austin-Healey '3000' 1959-60.

# HEADLAMPS



## VEHICLE APPLICATION REFERENCE—continued

58570 F700 (Export). 12v.; double contact; C.P.R.; less light unit. A.C. 'Ace' and 'Aceca' 1959-60. Austin 301 Range (except 301FC) 1960. M.G. MGA (later) 1960. Morris Commercial LC5, LCO5 and 'J2' 1960.	58610 F700 (vertical dip, Export). 12v.; double contact; C.P.R. Commer 'Express' Delivery Van and Pick-up Truck 1959-60.	58656 F700 (vertical dip, Export). 12v.; double contact; C.P.R. Commer 'Cob' 1959-60. Hillman 'Husky' Series I 1960.
58571 F700 (Export). 12v.; double contact; C.P.R.; less light unit. Austin Taxi and Hire Car 1960.	58611 F700P (vertical dip, Export). 12v.; double contact; C.P.R.; with pilot light. Rolls-Royce 'Silver Cloud' and 'Phantom' 1960.	58657 F700 (vertical dip, Export). 12v.; double contact; C.P.R.; peaked. Commer 'Cob' Series II 1960. Hillman 'Minx Special' Series IIIA and 'Husky' Series II 1960.
58572A F700 (Export). 12v.; double contact; C.P.R.; peaked; less light unit. Aston Martin DB4 1960. Wolseley 'Six Ninety-Nine' 1959-60.	58612 F700 (vertical dip, Export). 12v.; double contact; primer rim; peaked. Vauxhall 'Victor' 1960.	58669 F700 (Export). 12v.; double contact; C.P.R.; less light unit. Jaguar 2.4, 3.4 and 3.8 litre (later) and XK150 1960.
58581 PL700 (dip left). 12v.; double contact; C.P.R.; peaked. Austin 3 litre 'Princess' 1960.	58613 F700 (vertical dip, Export). 12v.; double contact; C.P.R. Bedford CA Van, TC and TJ 1960. Vauxhall All Models (except 'Victor' and 'Envoy') 1960.	58734 F700 (Export). 12v.; double contact; C.P.R.; peaked; American sealed beam light unit. Austin A55 Mk. II (later) 1960.
58585 F700 (vertical dip, Export). 12v.; double contact; C.P.R. Karrier 'Bantam' 1960.	58618 F700 (dip left, Export). 12v.; double contact; C.P.R.; Lucas sealed beam light unit. Layton Sports Car 'Jomar' 1960.	58772 F700 (Export). 12v.; double contact; C.P.R. (combined head and side lamp rim); American sealed beam light unit. Austin A40 1960.
58588 PF700 (vertical dip, Export). 12v.; double contact; C.P.R. Jaguar Mk. IX and XK150 (later) 1960.	58631 F700 (vertical dip, Export). 12v.; double contact; C.P.R. Lotus 'Elite' 1959-60.	58773 F700 (Export). 12v.; double contact; C.P.R.; American sealed beam light unit. Rover '80' and '100' (later) 1960.
58589 F700 (vertical dip, Export). 12v.; double contact; C.P.R. Rover 3 litre 1960.	58632 PF700 (vertical dip, Export). 12v.; double contact; C.P.R. Jaguar Mk. IX 1960.	58776 F700 (Export U.S.A.). 12v.; less light unit; C.P.R. Austin-Healey '3000' 1960.
58608 F700 (vertical dip, Export). 12v.; double contact; primer rim; peaked with C.P. edge. Singer 'Gazelle' 1960. Sunbeam 'Rapier' 1960.	58633 PF700 (vertical dip, Export). 12v.; double contact; C.P.R. Jaguar Mk. IX and XK150 1960.	053241 CFT700S. 12v.; E.B., C.P.R. finish. Morrison Electriccars D4, E and EH 1955-60.
58609 F700 (vertical dip, Export). 12v.; double contact; C.P.R.; peaked. Humber 'Hawk' and 'Super Snipe' 1960.	58634 F700 (vertical dip, Export). 12v.; double contact; C.P.R. Jaguar 2.4, 3.4 and 3.8 litre 1960.	056991 F700GS (vertical dip). 12v.; double contact; deep bronze green finish. Commer 3 ton four-wheel drive 1956.
	58655 F700 (vertical dip, Export). 12v.; double contact; primer rim; peaked. Hillman 'Minx' and 'Husky' Series II 1960. Sunbeam 'Alpine' 1960.	057458 F700 (dip left). 12v.; double contact; less rim. Trojan 20/25 cwt. 1959-60.
		54052111 F700 (dip left). 12v.; double contact; less rim. Simca-Aronde 'Elysée', 'Etoile' and 'Monthlery' 1960.

