

LUCAS

SECTION

REAR LAMPS

K

REFLEX REFLECTORS AND FLASHING INDICATOR SETS

INDEX

Part No.	Model	Description	Page No.	Part No.	Model	Description	Page No.
52114	1130	Tail	K52	53100	296	Number plate box	K9
52120	470-1	Reverse	K18	53101	467-2	Number plate	K11
52246	488	Reverse	K18	53102	471	Stop tail	K30
52272	538	Flasher (rear)	K5	53103	464	Stop tail and reverse	K48
52282	539	Flasher (rear)	K5	53104	465	Number plate	K11
52285	488	Reverse	K18	53107	474	Number plate	K11
52287	539	Flasher (rear)	K5	53108	474	Number plate	K11
52288	539	Flasher (rear)	K5	53109	474	Number plate	K11
52308	539	Reverse	K18	53110	474	Number plate	K11
52309	539	Reverse	K18	53111	288-3	Number plate box	K9
52314	585	Flasher (rear)	K5	53112	465	Number plate	K11
52315	585	Flasher (rear)	K5	53113	461	Stop	K20
52329	539	Flasher (rear)	K5	53114	288-3	Number plate box	K9
52330	539	Flasher (rear)	K5	53115	464	Stop tail and reverse	K48
52337	594	Flasher (rear)	K5	53116	476	Reverse, tail and number plate	K20
52339	538	Flasher (rear)	K5	53117	476	Stop tail and number plate	K25
52364	594	Flasher (rear)	K5	53118	476	Stop tail and number plate	K25
52371	593	Flasher (rear)	K5	53120	464	Stop tail	K30
52405	550	Number plate	K11	53121	479	Number plate	K11
52459	539	Flasher (rear)	K5	53123	464	Stop tail and reverse	K48
52460	539	Flasher (rear)	K5	53127	464	Stop tail	K30
52462	593	Flasher (rear)	K5	53128	464	Stop tail and reverse	K49
52463	550	Number plate	K11	53128	464	Reverse	K18
52503	539	Reverse	K18	53130	469	Number plate and reverse	K15
53007	AT201L	Tail and number plate	K50	53131	482	Stop tail	K30
A53007	AT201L	Tail and number plate	K50	53133	AT201L	Tail and number plate	K51
53008	ST38C	Stop tail and number plate	K23	53134	484	Stop tail	K30
A53008	ST38C	Stop tail and number plate	K23	53135	485	Number plate	K11
53019	L-WD-T2A	Tail	K52	53140	480	Tail and number plate	K51
53027	ST51-1	Stop tail and number plate	K23	53142	464	Stop tail and reverse	K49
53028	ST38D	Stop tail and number plate	K23	53143	464	Stop tail and reverse	K49
53029	ST51	Stop tail and number plate	K23	53145	464	Stop tail and flasher	K40
A53029	ST51	Stop tail and number plate	K23	53146	464	Stop tail and flasher	K40
53031	ST52	Stop tail and number plate	K23	53149	469	Number plate and reverse	K15
A53031	ST52	Stop tail and number plate	K23	53150	461-1	Stop tail	K30
53032	TR51-1	Reverse, tail and number plate	K20	53151	488	Stop tail	K31
53034	288-3	Number plate box	K9	53152	464	Number plate and reverse	K15
53035	TR51-1	Reverse, tail and number plate	K20	53153	464	Stop tail and flasher	K40
53036	WT203	Tail and number plate	K50	53156	464	Stop tail	K31
53037	WT203	Tail and number plate	K50	53159	469	Number plate and reverse	K15
53041	AT201L	Tail and number plate	K50	53161	469	Number plate and reverse	K15
53045	288-3	Number plate box	K9	53164	467	Number plate	K12
53049	ST53	Stop tail	K30	53166	464	Stop tail	K31
53051	285	Number plate box	K9	53171	469	Number plate	K12
53056	MT211	Tail and number plate	K50	53172	484	Stop tail	K31
A53056	MT211	Tail and number plate	K50	53173	464	Stop tail	K31
53057	ST54	Stop tail	K30	53174	464	Stop tail	K31
53060	ST51	Stop tail and number plate	K23	53174	464	Stop tail and flasher	K40
A53060	ST51	Stop tail and number plate	K23	53175	464	Stop tail and reverse	K49
53061	288-3	Number plate box	K9	53176	464	Stop tail and flasher	K40
53062	ST38C	Stop tail and number plate	K23	53177	464	Stop tail and reverse	K49
53063	ST38C	Stop tail and number plate	K24	53178	488	Stop tail	K31
53064	288-3	Number plate box	K9	53178	488	Stop tail and flasher	K40
53066	ST38C	Stop tail and number plate	K24	A53178	488	Stop tail	K31
53067	ST38C	Stop tail and number plate	K24	53179	464	Stop tail, reverse and boot	K49
53068	ST38C	Stop tail and number plate	K24	53180	464	Stop tail	K31
53071	ST38D	Stop tail and number plate	K24	53182	477-1	Stop tail and number plate	K25
A53071	ST38D	Stop tail and number plate	K24	53183	464	Stop tail and flasher	K40
53072	ST51-1	Stop tail and number plate	K24	53184	464	Stop tail and reverse	K49
53074	288-3	Number plate box	K9	53186	472	Number plate	K12
53075	288-3	Number plate box	K9	53189	472	Number plate	K11
53076	DC43	Stop tail and number plate	K24	53192	461	Stop tail	K31
53077	ST52D	Stop tail and number plate	K24	53193	461	Stop tail	K31
53079	ST51-1	Stop tail and number plate	K24	53194	461	Stop tail	K32
53080	288-3	Number plate box	K9	53196	464	Stop tail	K32
53081	ST51	Stop tail and number plate	K24	53197	471	Stop tail	K32
53082	461	Stop tail	K30	53198	464	Stop tail and reverse	K49
53083	288-3	Number plate box	K9	53199	464	Stop tail and flasher	K40
53089	288-3	Number plate box	K9	53200	471	Stop tail	K32
53091	461	Stop tail	K30	53201	464	Stop tail and reverse	K49
53092	464	Stop tail and reverse	K48	53202	464	Stop tail and reverse	K49
53093	467-2	Number plate	K11	53203	464	Stop tail and reverse	K49
A53093	467-2	Number plate	K11	53204	471	Stop tail	K32
53094	464	Stop tail and reverse	K48	53207	464	Stop	K20
53095	464	Stop tail and reverse	K48	53209	494	Reverse	K18
53097	469	Number plate and reverse	K15	53210	488	Reverse	K18
53098	464	Stop tail, reverse and boot	K48	53211	488	Stop tail	K32
53099	472	Stop tail	K30	53215	512	Number plate and reverse	K15

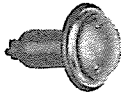

REAR LAMPS

INDEX—continued

Part No.	Model	Description	Page No.	Part No.	Model	Description	Page No.
53218	515	Stop tail	K32	53397	488	Tail	K52
53220	471	Stop tail	K32	53398	525	Stop tail and number plate ..	K26
53221	464	Stop tail and reverse ..	K49	53405	518-2	Stop tail	K34
53223	472	Reverse	K18	53407	570	Stop tail and flasher	K40
53224	472	Number plate	K12	53410	571	Stop tail and flasher	K40
53226	464	Stop tail	K32	53411	559	Flasher (rear)	K6
53227	464	Stop tail and flasher ..	K40	53412	464	Reverse	K19
53238	527	Number plate and reverse ..	K15	53414	469	Number plate and reverse ..	K16
53241	T38	Tail and number plate ..	K51	53417	AT202	Tail and number plate ..	K51
53243	528	Number plate and reverse ..	K15	53426	525	Stop tail and number plate ..	K26
53244	525	Stop tail and number plate ..	K25	53432	564	Stop tail and number plate ..	K21
53250	488	Tail	K52	53434	469	Number plate and reverse ..	K16
53255	512	Number plate and reverse ..	K15	53436	AT202	Tail and number plate ..	K51
53256	529	Tail and number plate ..	K51	53437	AT202	Stop	K20
53258	469	Number plate and reverse ..	K15	53439	ST38E	Stop tail and number plate ..	K26
53266	524	Number plate	K12	53440	ST38E	Stop tail and number plate ..	K26
53269	525	Stop tail and number plate ..	K25	53443	ST38E	Stop tail and number plate ..	K26
53271	531	Stop tail and reverse ..	K49	53443	ST38E	Tail and number plate ..	K51
53275	469	Number plate and reverse ..	K16	53444	572	Stop tail	K34
53276	465	Number plate	K12	53444	572	Stop tail and flasher	K40
53277	465	Number plate	K12	53452	574	Number plate and reverse ..	K16
53278	532	Number plate	K12	53453	512	Number plate and reverse ..	K16
53280	523	Stop tail and flasher ..	K41	53454	564	Stop tail and number plate ..	K21
53288	471	Stop tail	K32	53457	568	Flasher (rear)	K6
53290	531-1	Stop tail and reverse ..	K49	53459	DC43	Stop tail and number plate ..	K27
53291	537	Number plate	K13	53460	538RR	Stop tail	K34
53294	461	Flasher (rear)	K5	53462	469	Number plate and reverse ..	K16
53295	533	Stop tail and number plate ..	K25	53464	548	Stop tail and reverse ..	K49
53297	469	Number plate and reverse ..	K16	53464	548	Stop tail and flasher	K41
53298	538	Stop tail and flasher ..	K41	53465	572	Stop tail and flasher	K41
53304	533	Stop tail and number plate ..	K25	53479	558	Stop tail and flasher	K41
53305	542	Stop tail	K32	53481	528	Number plate and reverse ..	K16
53306	461-1	Stop tail and flasher ..	K41	53489	583	Stop tail and flasher	K41
53307	461	Reverse	K19	53494	556	Flasher (rear)	K6
53308	543	Number plate	K13	53495	553	Stop tail and flasher	K41
53310	546	Stop tail	K33	53501	539	Reverse	K19
53311	546	Stop tail	K33	53502	524	Number plate	K13
53312	546	Stop tail and flasher ..	K41	53503	538	Flasher (rear)	K7
53313	546	Stop tail and flasher ..	K41	53504	488	Flasher (rear)	K7
53314	547	Number plate	K13	53513	582	Tail and number plate ..	K51
53315	488	Stop	K20	53515	461-1	Reverse	K19
53315	488	Flasher (rear)	K5	53516	553	Stop tail and number plate ..	K41
53315	488	Tail	K52	53518	534	Number plate	K12
53317	469	Number plate and reverse ..	K16	53520	581	Stop tail	K34
53318	471	Stop tail	K33	53522	553	Stop tail and flasher	K41
53320	467-2	Number plate	K13	53523	469	Number plate and reverse ..	K16
53322	548	Stop tail and reverse ..	K49	53527	548	Stop tail and flasher	K41
53330	549	Stop tail and flasher ..	K41	53533	538	Tail	K52
53330	549	Stop tail	K33	53534	533	Stop tail and number plate ..	K27
53332	551	Stop tail	K33	53539	572	Stop tail and flasher	K41
53333	539	Flasher (rear)	K5	53540	572	Stop tail and flasher	K41
53339	553	Stop tail and flasher ..	K41	53541	523	Stop tail and flasher	K41
53340	549	Stop tail and flasher ..	K41	53546	574	Number plate and reverse ..	K17
53341	549	Stop tail and flasher ..	K41	53547	587	Stop tail and flasher ..	K41, K42
53343	554	Number plate	K13	53551	469	Number plate and reverse ..	K17
53346	554	Number plate	K13	53553	589	Stop tail and flasher	K42
53348	534	Number plate	K13	53554	589	Stop tail and flasher	K42
53350	549	Stop tail and flasher ..	K41	53556	512	Number plate and reverse ..	K17
53350	549	Stop tail	K33	53557	512	Number plate and reverse ..	K17
53351	549	Stop tail and flasher ..	K40	53558	574	Number plate and reverse ..	K17
53351	549	Stop tail	K33	53564	594	Stop tail	K34
53356	558	Stop tail and flasher ..	K40	53564	594	Stop tail and flasher	K42
53358	556	Flasher (rear)	K6	53565	593	Stop tail and flasher	K42
53359	488	Flasher (rear)	K6	53566	551	Stop tail	K34
53362	559	Flasher (rear)	K6	53573	469	Number plate and reverse ..	K17
53367	556	Flasher (rear)	K6	53574	518-2	Stop tail and number plate ..	K27
53368	556	Flasher (rear)	K6	53576	549	Stop tail	K34
53372	538	Stop tail	K33	53576	549	Stop tail and flasher	K42
53372	538	Stop tail and flasher ..	K40	53577	549	Stop tail	K34
53374	467-2	Number plate	K13	53577	549	Stop tail and flasher	K42
53376	465	Number plate and reverse ..	K16	53578	ST38	Stop tail and number plate ..	K27
53377	551	Stop tail	K33	53579	593	Stop tail and flasher	K42
53377	551	Stop tail and flasher ..	K40	53580	288	Number plate box	K9
53378	539	Reverse	K19	53582	288	Number plate box	K9
53381	549	Stop tail and flasher ..	K40	53583	288	Number plate box	K9
53382	549	Stop tail and flasher ..	K40	53584	288	Number plate box	K9
53384	551	Stop tail	K34	53585	285	Number plate box	K9
53388	467-2	Number plate	K13	53586	596	Stop tail and flasher	K43
53389	ST51	Stop tail and number plate ..	K25	53587	596	Stop tail and flasher	K43
53390	ST51	Stop tail and number plate ..	K25	53588	597	Stop tail and flasher	K47
53392	ST51	Stop tail and number plate ..	K26	53589	597	Stop tail	K34, K35
53393	518-2	Stop tail and number plate ..	K26	53590	597	Stop tail and flasher	K47
53394	564	Stop tail and number plate ..	K21	53591	597	Stop tail and flasher	K47
53395	469	Stop tail and number plate ..	K26				

REAR LAMPS

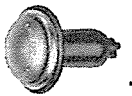

INDEX—continued

Part No.	Model	Description	Page No.	Part No.	Model	Description	Page No.
53592	597	Stop tail	K35	53756	627	Stop tail and flasher	K45
53593	597	Stop tail and flasher	K47	53757	627	Stop tail and flasher	K45
53594	ST54	Stop tail	K35	53758	627	Stop tail and flasher	K45
53595	599	Number plate	K12	53759	627	Stop tail and flasher	K45
53596	600	Stop tail and flasher	K43	53760	627	Stop tail and flasher	K45
53599	601	Stop tail	K35	53761	582	Tail and number plate	K51
53600	594	Flasher (rear)	K7	53762	631	Stop tail and flasher	K45
53600	594	Stop	K20	53763	534	Number plate	K12
53602	554	Number plate	K12	53764	607	Flasher (rear)	K7
53603	528	Number plate and reverse	K17	53765	607	Flasher (rear)	K7
53604	528	Number plate and reverse	K17	53766	467	Number plate	K13
53606	469	Number plate and reverse	K17	53769	631	Stop tail and flasher	K45
53607	604	Flasher (rear)	K7	53770	635	Stop tail and flasher	K45
53608	518-2	Stop tail	K35	53771	635	Stop tail and flasher	K45
53610	488	Flasher (rear)	K7	53772	636	Stop tail and flasher	K44
53614	582	Tail and number plate	K51	53773	637	Flasher (rear)	K7
53615	582	Tail and number plate	K51	53774	640	Stop tail and flasher	K44
53616	553	Stop tail and flasher	K51	53775	640	Stop tail and flasher	K44
53624	538	Stop tail and flasher	K43	53776	641	Stop tail and flasher	K44
53624	538	Stop tail	K35	53777	641	Stop tail and flasher	K44
53625	538	Tail	K52	53778	559	Flasher (rear)	K7
53626	539	Flasher (rear)	K7	53779	642	Stop tail and flasher	K44
53628	538	Flasher (rear)	K7	53783	581	Stop tail	K36
53629	ST38E	Stop tail and number plate	K27	53786	643	Number plate	K13
53630	532	Number plate	K12	53787	644	Reverse	K19
53633	534	Number plate	K12	53789	645	Reverse	K19
53634	558	Stop tail and flasher	K43	53790	635	Stop tail and flasher	K44
53637	568	Flasher (rear)	K7	53791	635	Stop tail and flasher	K44
53639	570	Stop tail and flasher	K43	53792	646	Stop tail and flasher	K45
53640	572	Stop tail and flasher	K43	53793	646	Stop tail and flasher	K45
53642	606	Stop tail	K35	53794	646	Stop tail and flasher	K45
53643	587	Stop tail and flasher	K43	53795	646	Stop tail and flasher	K45
53644	607	Flasher (rear)	K7	53797	647	Stop tail and flasher	K45
53645	607	Flasher (rear)	K7	53798	647	Stop tail and flasher	K45
53648	572	Stop tail and flasher	K43	53799	647	Stop tail and flasher	K45
53650	467-2	Number plate	K12	53800	647	Stop tail and flasher	K45
53660	558	Stop tail and flasher	K42	53801	642	Stop tail and flasher	K45
53663	596	Stop tail and flasher	K42	53806	637	Flasher (rear)	K7
53664	596	Stop tail and flasher	K42	53807	559	Flasher (rear)	K7
53665	596	Stop tail and flasher	K42	53808	617	Flasher (rear)	K7
53666	596	Stop tail and flasher	K42	53809	617	Flasher (rear)	K7
53669	597	Stop tail and flasher	K47	53814	649	Number plate	K13
53670	597	Stop tail	K35	53815	620	Stop tail and flasher	K45
53671	597	Stop tail and flasher	K47	53816	636	Stop tail and flasher	K45
53677	538	Flasher (rear)	K7	53818	538	Stop tail	K36
53678	538	Tail	K52	53819	551	Stop tail	K36
53679	551	Tail	K52	53822	534	Number plate	K13
53685	572	Stop tail and flasher	K42	53823	654	Stop tail and flasher	K46
53686	539	Stop	K20	53824	654	Stop tail and flasher	K46
53686	539	Flasher (rear)	K6	53826	532	Number plate	K13
53688	538	Flasher (rear)	K6	53833	657	Stop tail and flasher	K46
53689	548	Stop tail and flasher	K42	53836	467	Number plate	K13
53693	601	Stop tail	K36	53837	467	Number plate	K13
53694	600	Stop tail and flasher	K42	53838	549	Stop tail	K36
53695	572	Stop tail and flasher	K43	53838	549	Stop tail and flasher	K46
53699	VP64	Stop tail and number plate	K21	53839	549	Stop tail	K36
53702	606	Stop tail	K36	53839	549	Stop tail and flasher	K46
53703	616	Stop tail and flasher	K43	53840	538	Stop tail	K36
53704	616	Stop tail and flasher	K43	53841	539	Flasher (rear)	K7
53705	534	Number plate	K12	53842	539	Flasher (rear)	K7
53706	617	Flasher (rear)	K6	53846	657	Stop tail and flasher	K46
53707	617	Flasher (rear)	K6	53861	539	Flasher (rear)	K7
53710	570	Stop tail and flasher	K43	53875	551	Stop tail	K36
53711	620	Stop tail and flasher	K43	53876	467-2	Number plate	K13
53712	621	Stop tail and flasher	K43	53902	594	Tail	K52
53713	621	Stop tail and flasher	K43	53905	469	Number plate	K13
53715	572	Stop tail and flasher	K43	53906	488	Stop tail	K36
53717	607	Flasher (rear)	K6	052671	494	Reverse	K19
53718	607	Flasher (rear)	K6	052672	494	Reverse	K19
53719	623	Number plate and reverse	K17	052707	511	Reverse	K19
53721	539	Flasher (rear)	K6	052708	511	Reverse	K19
53726	627	Stop tail and flasher	K43	052993	548	Reverse lamp kit	K19
53727	627	Stop tail and flasher	K43	058619	539/551	Stop tail and flasher	K46
53728	627	Stop tail and flasher	K43	058647	538/551	Stop tail and flasher	K46
53729	627	Stop tail and flasher	K44	058720	494	Reverse	K19
53738	627	Stop tail and flasher	K44	058721	494	Reverse	K19
53739	627	Stop tail and flasher	K44	058722	511	Reverse	K19
53744	617	Flasher (rear)	K6	058723	511	Reverse	K19
53750	629	Stop tail and flasher	K44	523595	ST38C	Stop tail and number plate	K27
53751	629	Stop tail and flasher	K44	524752	ST51	Stop tail and number plate	K27
53752	572	Stop tail and flasher	K44	524753	ST51	Stop tail and number plate	K27
53753	572	Stop tail and flasher	K44	525123	ST50C	Stop tail and number plate	K27
53754	572	Stop tail and flasher	K44	525133	TR50C	Reverse, tail and number plate	K20
53755	627	Stop tail and flasher	K45	575923	574	Number plate and reverse	K17



FLASHER LAMPS, Rear

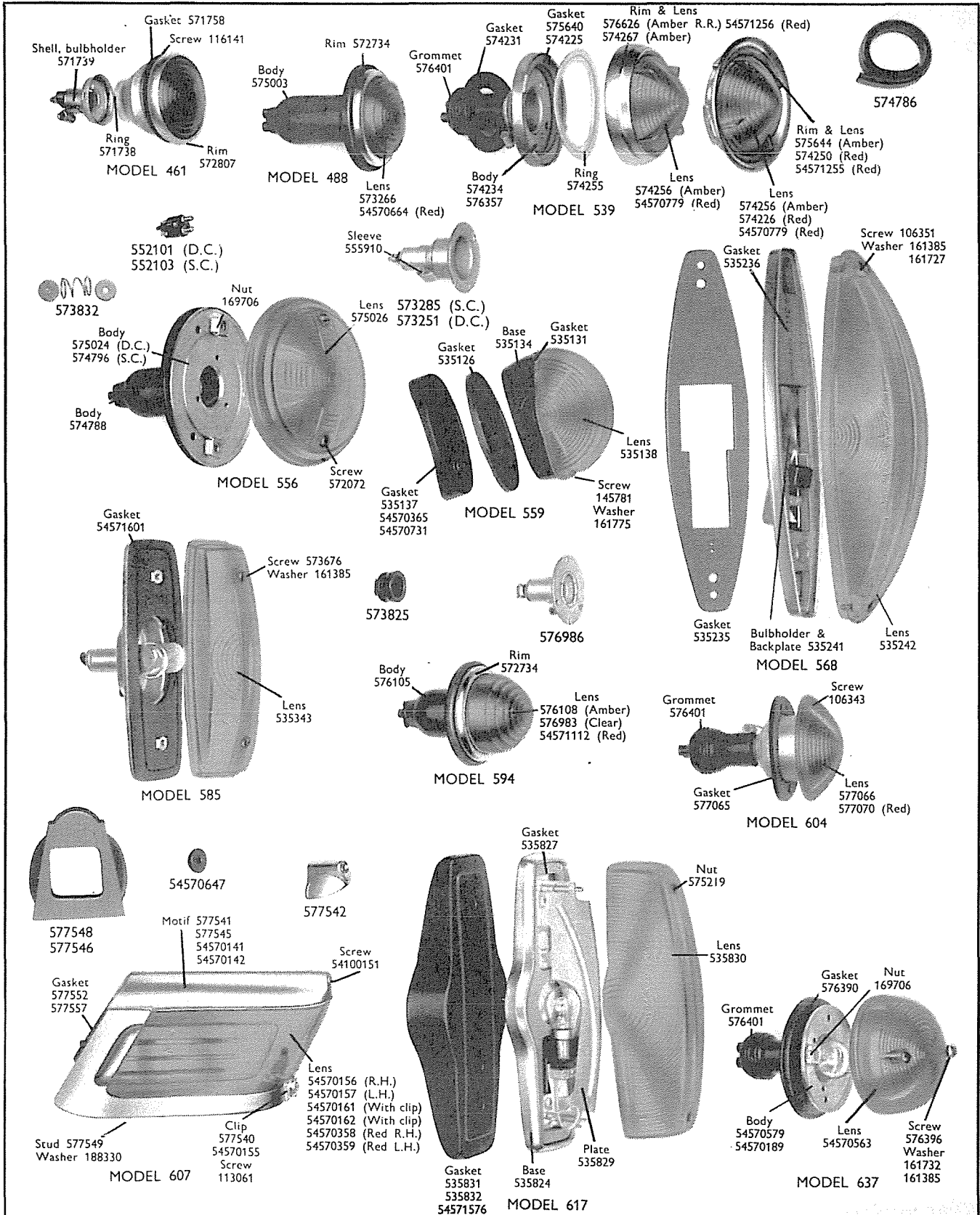

For detailed spare parts, see pages K5-K7

FLASHER LAMPS, Rear

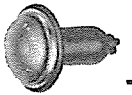

DETAILED SPARE PARTS

Part No.	†52272D	†52282A/B	52287A/D	52288A/D	52314A/B	52315A/B	52329B/D	52330B/D	52337A/B
Model	538	539	539	539	585	585	539	539	594
Finish	C.P.R.	C.P.R.	C.P.R.	C.P.R.	—	—	C.P.R.	C.P.R.	C.P.R.
Replaced by (see footnote)	(53626)	(53626)	—	—	—	—	—	—	—
§Rim or door	‡574267	‡574267	‡576626	‡576626	—	—	‡54571256	‡54571256	572734
§Lens or glass	574256	574256	574256	574256	535343	535343	54570779	54570779	576108
§Screw or nut, lens or rim fixing	—	—	—	—	573676	573676	—	—	—
Washer, screw retaining	—	—	—	—	161385	161385	—	—	—
§Ring, sliding	574255	574255	574255	574255	—	—	574255	574255	—
§Gasket, lens seating	575640	575640	575640	575640	54571601	54571601	575640	575640	—
§Body, rubber	—	—	—	—	—	—	—	—	576105
Body or backplate	574234	574234	—	—	—	—	—	—	576986
§Interior, bulb holder	573832	573832	573832	573832	573832	573832	573832	573832	552103
§Bulb	382	382	382	382	382	339	382	382	382
§Sleeve, terminal	—	—	—	—	555910	555910	—	—	555910
§Grommet, cable entry	—	—	—	—	—	—	—	—	—
§Gasket, body or lamp seating	574231	574231	574231	574231	—	—	574231	574231	—
Motif, nose	—	—	—	—	—	—	—	—	—
Motif, top	—	—	—	—	—	—	—	—	—
§Screw, top motif fixing	—	—	—	—	—	—	—	—	—
§Screw, lens clip fixing	—	—	—	—	—	—	—	—	—
Clip, lens	—	—	—	—	—	—	—	—	—
Stud, lamp fixing	—	—	—	—	—	—	—	—	—
Washer, locking	—	—	—	—	—	—	—	—	—
Screw, grub, terminal	—	—	—	—	—	—	—	—	—
Plate, baffle	—	—	—	—	—	—	—	—	—
Shell, bulb holder	—	—	—	—	—	—	—	—	—
Ring, adaptor shell fixing	—	—	—	—	—	—	—	—	—
Base	—	—	—	—	—	—	—	—	—

Part No.	†52339A	52364A/B	52371A	52459A/B	52460A/B	†52462A	53294A	53315E/F	†53333A/H
Model	538	594	539	539	539	539	461	488	539
Finish	C.P.R.	C.P.R.	C.P.R.	—	—	C.P.R.	C.P.R.	C.P.R.	C.P.R.
Replaced by (see footnote)	(53626)	—	—	—	—	(53626)	—	—	(53628)
§Rim or door	‡574267	572734	‡575644	—	—	‡574267	‡572807	572734	‡54571255
§Lens or glass	574256	576108	574256	574256	54570779	574256	—	54570664	54570779
§Screw or nut, lens or rim fixing	—	—	—	—	—	—	116141	—	—
Washer, screw retaining	—	—	—	—	—	—	—	—	—
Washer, leatheroid or fibre	—	—	—	—	—	—	—	—	—
§Ring, sliding	574255	—	574255	574255	574255	574255	—	—	574255
§Gasket, lens seating	575640	—	575640	575640	575640	575640	—	—	575640
§Body, rubber	—	576105	—	—	—	—	—	575003	—
Body or backplate	574234	576986	574234	574234	574234	574234	—	573285	574234
§Interior, bulb holder	573832	552103	573832	573832	573832	573832	552103	552103	573832
§Bulb	382	317	382	382	382	382	382	221	382
§Sleeve, terminal	—	555910	—	—	—	—	188818	555910	—
§Grommet, cable entry	—	—	576401	—	—	—	—	—	573825
§Gasket, body or lamp seating	574231	—	574231	574231	574231	574231	571758	—	574231
Motif, nose	—	—	—	—	—	—	—	—	—
Motif, top	—	—	—	—	—	—	—	—	—
§Screw, top motif fixing	—	—	—	—	—	—	—	—	—
§Screw, lens clip fixing	—	—	—	—	—	—	—	—	—
Clip, lens	—	—	—	—	—	—	—	—	—
Stud, lamp fixing	—	—	—	—	—	—	—	—	—
Washer, locking	—	—	—	—	—	—	—	—	—
Screw, grub, terminal	—	—	—	—	—	—	—	—	—
Shell, bulb holder	—	—	—	—	—	—	571739	—	—
Ring, adaptor shell fixing	—	—	—	—	—	—	571738	—	—
Base	—	—	—	—	—	—	—	—	—

For illustrations, see page K4

Note. For replacement lamp spare parts, see appropriate column under part number † When ordering, quote part number shown in brackets
 ‡ With lens § Recommended spares for stock C.P.R. . . . Chromium plated rim

continued

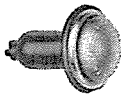

FLASHER LAMPS, Rear

DETAILED SPARE PARTS

Part No.	53358D	53359A/E	53362A/B	53367D	53368D	53411A/B	53457A/D	53494B
Model	556	488	559	556	556	559	568	556
Finish	—	C.P.R.	—	—	—	—	—	—
Replaced by (see footnote)	—	—	—	—	—	—	—	—
(1) §Rim or door	—	572734	—	—	—	—	—	—
(2) §Lens or glass	575026	573266	535138	575026	575026	535138	535242	575026
(3) §Screw or nut, lens or rim fixing	572072	—	145781	572072	572072	145781	106351	572072
(4) Washer, screw retaining	161385	—	161775	161385	161385	161775	161385	161385
(5) Washer, leatheroid or fibre	161727	—	—	161727	161727	—	161727	161727
(6) §Ring, sliding	—	—	—	—	—	—	—	—
(7) §Gasket, lens seating	574786	—	535131	574786	574786	535131	535236	574786
(8) §Body, rubber	574788	575003	—	574788	574788	—	—	574788
(9) Body or backplate	574796	573285	—	575024	575024	—	535241	575024
(10) §Interior, bulb holder	552103	552103	—	552101	552101	—	—	552101
(11) §Bulb	382	382	382	335	333	382	335	338
(12) §Sleeve, terminal	555910	555910	188818	555910	555910	188818	—	555910
(13) §Grommet, cable entry	—	—	—	—	—	—	—	—
(14) §Gasket, body or lamp seating	—	—	535126	—	—	535137	535235	—
(15) Motif, nose	—	—	—	—	—	—	—	—
(16) Motif, top	—	—	—	—	—	—	—	—
(17) §Screw, top motif fixing	—	—	—	—	—	—	—	—
(18) §Screw, lens clip and top motif fixing	—	—	—	—	—	—	—	—
(19) Clip, lens	‡169706	—	—	‡169706	‡169706	—	—	‡169706
(20) Stud, lamp fixing	—	—	—	—	—	—	—	—
(21) Washer, locking	—	—	—	—	—	—	—	—
(22) Screw, grub, terminal	—	—	—	—	—	—	120560	—
(23) Plate, baffle	—	—	—	—	—	—	—	—
(24) Shell, bulb holder	—	—	—	—	—	—	—	—
(25) Base	—	—	535134	—	—	535134	—	—

Part No.	53686A/E	53688A/D	53706A	53707A	53717A/E	53718A/E	†53721A/B	53744A/B
Model	539	604	617	617	607	607	539	617
Finish	C.P.R.	—	—	—	—	—	C.P.R.	Chromium base
Replaced by (see footnote)	—	—	—	—	—	—	(53626)	—
(1) §Rim or door	‡54571256	—	—	—	—	—	‡574267	—
(2) §Lens or glass	54570779	577070	535830	535830	54570156	54570157	574256	535830
(3) §Screw or nut, lens or rim fixing	—	106343	575219	575219	—	—	—	575219
(4) Washer, screw retaining	—	—	—	—	—	—	—	—
(5) Washer, leatheroid or fibre	—	—	—	—	—	—	—	—
(6) §Ring, sliding	574255	—	—	—	—	—	574255	—
(7) §Gasket, lens seating	575640	—	535827	535827	577546	577548	574225	535827
(8) §Body, rubber	—	—	—	—	—	—	—	—
(9) Body or backplate	574234	—	535824	535824	—	—	576357	—
(10) §Interior, bulb holder	573832	573832	—	—	573832	573832	573832	—
(11) §Bulb	382	382	335	335	382	382	382	335
(12) §Sleeve, terminal	—	—	—	—	555910	555910	—	—
(13) §Grommet, cable entry	573825	576401	—	—	54570647	54570647	573825	—
(14) §Gasket, body or lamp seating	574231	577065	535831	535832	577552	577557	574231	54571576
(15) Motif, nose	—	—	—	—	—	—	—	—
(16) Motif, top	—	—	—	—	54570141	54570142	—	—
(17) §Screw, top motif fixing	—	—	—	—	54100151	54100151	—	—
(18) §Screw, lens clip and top motif fixing	—	—	—	—	113061	113061	—	—
(19) Clip, lens	—	—	—	—	54570155	54570155	—	—
(20) Stud, lamp fixing	—	—	—	—	577549	577549	—	—
(21) Washer, locking	—	—	—	—	188330	188330	—	—
(22) Screw, grub, terminal	—	—	120560	120560	—	—	—	120560
(23) Plate, baffle	—	—	535829	535829	—	—	—	535829
(24) Shell, bulb holder	—	—	—	—	—	—	—	—
(25) Base	—	—	—	—	—	—	—	535824

For illustrations, see page K4

Note. For replacement lamp spare parts, see appropriate column under part number † When ordering, quote part number shown in brackets ‡ With lens
 § Recommended spares for stock ¶ Nut, lens fixing screw C.P.R. . . Chromium plated rim

FLASHER LAMPS, Rear

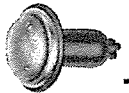

DETAILED SPARE PARTS

‡53503D/E	53504A/B	53600A/E	53607A/F	53610A/B	53626A	53628A	53637A	†53644A/D	†53645A/D	53677A	
538	488	594	604	488	539	538	568	607	607	538	
C.P.R.	C.P.R.	C.P.R.	—	C.P.R.	C.P.R.	C.P.R.	—	—	—	—	
(53626)	—	—	—	—	—	—	—	(53717)	(53718)	—	
‡574267	572734	572734	—	572734	‡574267	‡574250	—	—	—	—	(1)
574256	573266	54571112	577066	573266	574256	574226	535242	54570161	54570162	574226	(2)
—	—	—	106343	—	—	—	106351	—	—	—	(3)
—	—	—	—	—	—	—	161385	—	—	—	(4)
—	—	—	—	—	—	—	161727	—	—	—	(5)
574255	—	—	—	—	574255	574255	—	—	—	574255	(6)
575640	—	—	—	—	575640	575640	535236	577546	577548	575640	(7)
—	575003	576105	—	575003	—	—	—	—	—	—	(8)
576357	576099	576986	—	573251	576357	574234	535241	—	—	574234	(9)
573832	573832	552103	573832	552101	573832	573832	—	573832	573832	573832	(10)
382	382	382	382	335	382	382	—	382	382	382	(11)
—	555910	555910	—	555910	—	—	—	555910	555910	—	(12)
573825	—	—	576401	576401	576401	576401	—	—	—	—	(13)
574231	—	—	577065	—	—	574231	535235	577552	577557	574231	(14)
—	—	—	—	—	—	—	—	577542	577542	—	(15)
—	—	—	—	—	—	—	—	577541	577545	—	(16)
—	—	—	—	—	—	—	—	186134	186134	—	(17)
—	—	—	—	—	—	—	—	—	—	—	(18)
—	—	—	—	—	—	—	—	113061	113061	—	(19)
—	—	—	—	—	—	—	—	577540	577540	—	(20)
—	—	—	—	—	—	—	—	577549	577549	—	(21)
—	—	—	—	—	—	—	—	188330	188330	—	(22)
—	—	—	—	—	—	—	120560	—	—	—	(23)
—	—	—	—	—	—	—	—	—	—	—	(24)
—	—	—	—	—	—	—	—	—	—	—	(25)

53764A/E	53765A/E	53773A	53778A	53806A/D	53807A	53808A	53809A	53841A	53842A	53861A	
607A	607A	637	559	637	559	617	617	539	539	539	
—	—	—	—	—	—	—	—	C.P.R.	C.P.R.	C.P.R.	
—	—	—	—	—	—	—	—	(53626)	—	—	
—	—	—	—	—	—	—	—	‡574267	‡54571256	‡54571256	(1)
54570358	54570359	54570563	535138	54570563	535138	535830	535830	574256	54570779	54570779	(2)
—	—	576396	145781	576396	145781	575219	575219	—	—	—	(3)
—	—	161385	161775	161385	161775	—	—	—	—	—	(4)
—	—	161732	—	161732	—	—	—	—	—	—	(5)
—	—	—	—	—	—	—	—	574255	574255	574255	(6)
577546	577548	—	535131	—	535131	535827	535827	575640	575640	575640	(7)
—	—	—	—	—	—	—	—	—	—	—	(8)
—	—	54570189	—	54570579	—	535824	535824	576357	576357	574234	(9)
573832	573832	552103	—	573832	—	—	—	573832	573832	573832	(10)
382	382	382	382	382	382	319	319	382	382	382	(11)
555910	555910	555910	188818	555910	188818	—	—	—	—	—	(12)
54570647	54570647	—	—	576401	—	—	—	—	—	—	(13)
577552	577557	576390	54570365	576390	54570731	535831	535832	574231	574231	574231	(14)
—	—	—	—	—	—	—	—	—	—	—	(15)
54570141	54570142	—	—	—	—	—	—	—	—	—	(16)
54100151	54100151	—	—	—	—	—	—	—	—	—	(17)
—	—	—	—	—	—	—	—	—	—	—	(18)
113061	113061	—	—	—	—	—	—	—	—	—	(19)
54570155	54570155	‡169706	—	‡169706	—	—	—	—	—	—	(20)
577549	577549	—	—	—	—	—	—	—	—	—	(21)
188330	188330	—	—	—	—	—	—	—	—	—	(22)
—	—	—	—	—	—	120560	120560	—	—	—	(23)
—	—	—	—	—	—	535829	535829	—	—	—	(24)
—	—	—	—	—	—	—	—	—	—	—	(25)

For illustrations, see page K4

† When ordering, quote part number shown in brackets

‡ With lens

‖ Nut, lens fixing screw

C.P.R. ... Chromium plated rim



NUMBER PLATE LAMPS, Box Type

Screw
572289

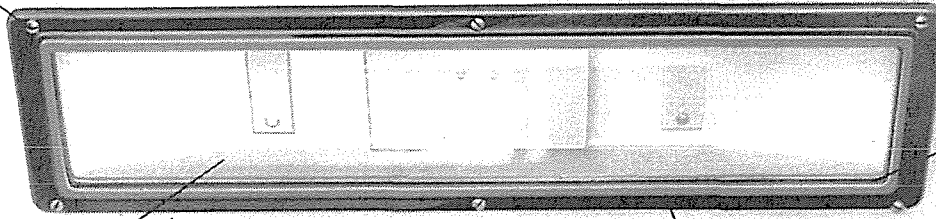
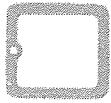

Plate lens
seating
572275

Window 572278

MODEL 296

Cover 572290



572281

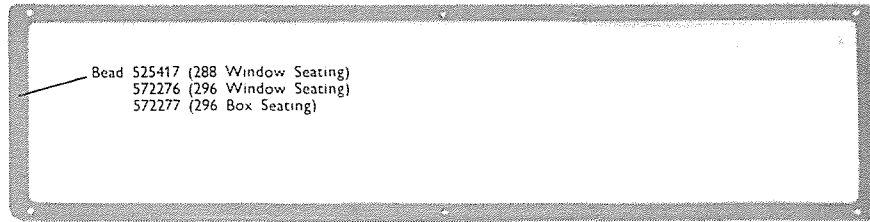

Bead 525417 (288 Window Seating)
572276 (296 Window Seating)
572277 (296 Box Seating)



Bead & Plate 524473

Cover 523497 (288 Type)
525428 (285 Type)

Rim
523333

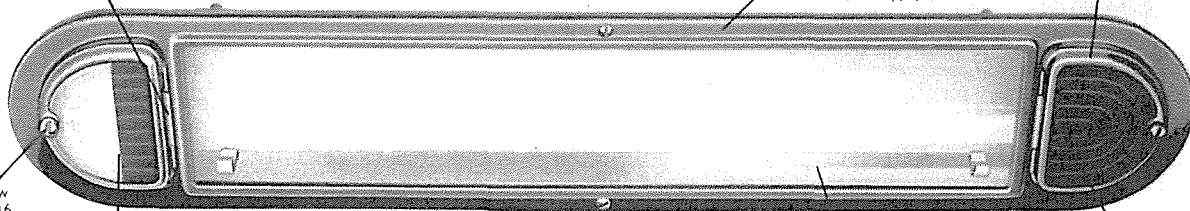

Hinge Wire
523325

Screw
523316
Bush
523318

Lens
523308

MODEL 288-3

Window 521654

Lens
523307
571717

285 (Less Body)



571707

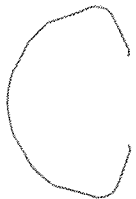

523323

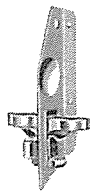

523499
524451
524452



523324

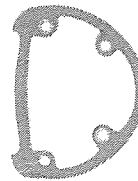

571713

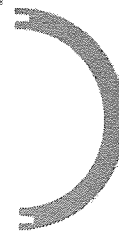

571706

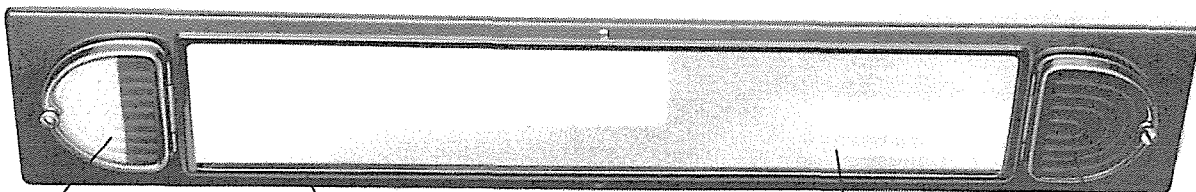

Lens 523308

Cover
571685

Window
521654

Lens
523307
571717

For detailed spare parts, see page K9

NUMBER PLATE LAMPS, Box Type

DETAILED SPARE PARTS

Part No.	†53034A	†53045B	†53051A	†53061A	†53064A	†53074B	†53075B	53080A	†53083A
Model	288-3	288-3	285	288-3	288-3	288-3	288-3	288-3	288-3
Finish	Black, C.P.R.	Black, C.P.R.	Black, C.P.R.	Primer, C.P.R.	Black, C.P.R.	Black, C.P.R.	Black, C.P.R.	Black, C.P.R.	Black, C.P.R.
Replaced by (see footnote)	(53580)	(53580)	(53585)	(53580)	(53580)	(53582)	(53583)	—	(53580)
§Rim or door	523333	523333	523333	523333	523333	523333	523333	523333	523333
Wire, hinge	523325	523325	523325	523325	523325	523325	523325	523325	523325
Washer, langite	523324	523324	523324	523324	523324	523324	523324	523324	523324
§Wires, lens fixing	523323	523323	523323	523323	523323	523323	523323	523323	523323
§Screw, fixing	523316	523316	523316	523316	523316	523316	523316	523316	523316
Bush	523318	523318	523318	523318	523318	523318	523318	523318	523318
§Lens, stop tail	523307	¶523307	523307	¶523307	523307	523307	523307	—	523307
§Lens, reverse tail	523308	—	523308	—	523308	523308	523308	¶523308	523308
§Cover	523497	523497	525428	523497	523497	571685	523497	523497	523497
Nut, lens retaining plate	165033	165033	165033	165033	165033	165033	165033	165033	165033
Plate, with bead	524473	524473	524473	524473	524473	524473	524473	524473	524473
§Bead or channel	525417	525417	525417	525417	525417	525417	525417	525417	525417
§Strip, rubber	571707	571707	—	571707	571707	571707	571707	571707	571707
§End piece, rubber	571706	571706	—	571706	571706	571706	571706	571706	571706
Screw, cover fixing	113531	113531	—	113531	113531	113531	113531	113531	113531
Screw, cover fixing	126544	126544	—	126544	126544	126544	126544	126544	126544
Washer, screw retaining	161385	161385	—	161385	161385	161385	161385	161385	161385
Washer, front rim	571713	571713	571713	571713	571713	571713	571713	571713	571713
§Window, rolled sheet	521654	521654	521654	521654	521654	521654	521654	521654	521654
Partition, stop tail	524451	524451	—	524451	524451	524451	524451	524451	524451
Partition, stop tail	—	523499	—	523499	—	—	—	—	—
§Sleeve, earth terminal	188818	188818	188818	188818	188818	188818	188818	188818	188818
Partition, tail and reverse	524452	—	—	—	524452	524452	524452	524452	524452
§Bulb	207	‡207	207	¶207	207	207	207	¶207	207
§Bulb, reverse	No. 1	—	No. 1	¶No. 1	No. 1	No. 1	No. 1	¶No. 1	No. 1
Gasket, box seating	—	—	—	—	—	—	—	—	—
Gasket, window seating	—	—	—	—	—	—	—	—	—
§Interior, bulb holder	—	—	—	—	—	—	—	—	—

Part No.	53089A	53100A	†53111A	53114A	53580A	53582A	53583A	53584A	53585A
Model	288-3	296	288-3	288-3	288-3	288-3	288-3	288-3	285
Finish	Black, C.P.R.	Black	Black, C.P.R.	Black, C.P.R.	Black, C.P.R.	Black, C.P.R.	Black, C.P.R.	Black, C.P.R.	C.P.R.
Replaced by (see footnote)	—	—	(53584)	—	—	—	—	—	—
§Rim or door	523333	—	523333	523333	523333	523333	523333	523333	523333
Wire, hinge	523325	—	523325	523325	523325	523325	523325	523325	523325
Washer, langite	523324	—	523324	523324	523324	523324	523324	523324	523324
§Wires, lens fixing	523323	—	523323	523323	523323	523323	523323	523323	523323
§Screw, fixing	523316	523316	523316	523316	523316	523316	523316	523316	523316
Bush	523318	—	523318	523318	—	—	—	—	—
§Lens, stop tail	523307	—	523307	—	571717	571717	571717	571717	571717
§Lens, reverse tail	523308	—	523308	¶523308	—	—	—	—	—
§Cover	523497	572290	523497	523497	523497	571685	523497	523497	525428
Nut, lens retaining plate	165033	—	165033	165033	165033	165033	165033	165033	165033
Plate, with bead	524473	—	524473	524473	524473	524473	524473	524473	535421
§Bead or channel	525417	572281	525417	525417	525417	525417	525417	525417	525417
§Strip, rubber	571707	¶572275	571707	571707	571707	571707	571707	571707	—
§End piece, rubber	571706	—	571706	571706	571706	571706	571706	571706	—
Screw, cover fixing	113531	572289	113531	113531	113531	113531	113531	113531	—
Screw, cover fixing	126544	—	126544	126544	—	—	—	—	—
Washer, screw retaining	161385	161385	161385	161385	161385	161385	161385	161385	161385
Washer, front rim	571713	—	571713	571713	571713	571713	571713	571713	571713
§Window, rolled sheet	521654	572278	521654	521654	521654	521654	521654	521654	521654
Partition, stop tail	524451	—	524451	524451	—	—	—	—	—
Partition, stop tail	—	—	—	—	—	—	—	—	—
§Sleeve, earth terminal	188818	188818	188818	188818	555910	555910	555910	555910	188818
Partition, tail and reverse	524452	—	524452	524452	—	—	—	—	—
§Bulb	207	222	207	¶207	¶380	¶380	¶380	¶380	§¶382
§Bulb, reverse	No. 1	—	No. 1	¶No. 1	—	—	—	—	**¶207
Gasket, box seating	—	572277	—	—	††175156	—	††175060	††175156	††169253
Gasket, window seating	—	572276	—	—	††185067	—	††185026	††185067	††188351
§Interior, bulb holder	—	553780	—	—	—	—	—	—	—

For illustrations, see page K8

Note. For replacement lamp spare parts, see appropriate column under part number † When ordering, quote part number shown in brackets ‡ 4 off
 § Recommended spares for stock ¶ Glass retaining ¶ 2 off § Stop tail ** Tail †† Nut, box fixing †† Washer, fixing nut



NUMBER PLATE LAMPS

(including Number Plate and Boot Lamps)

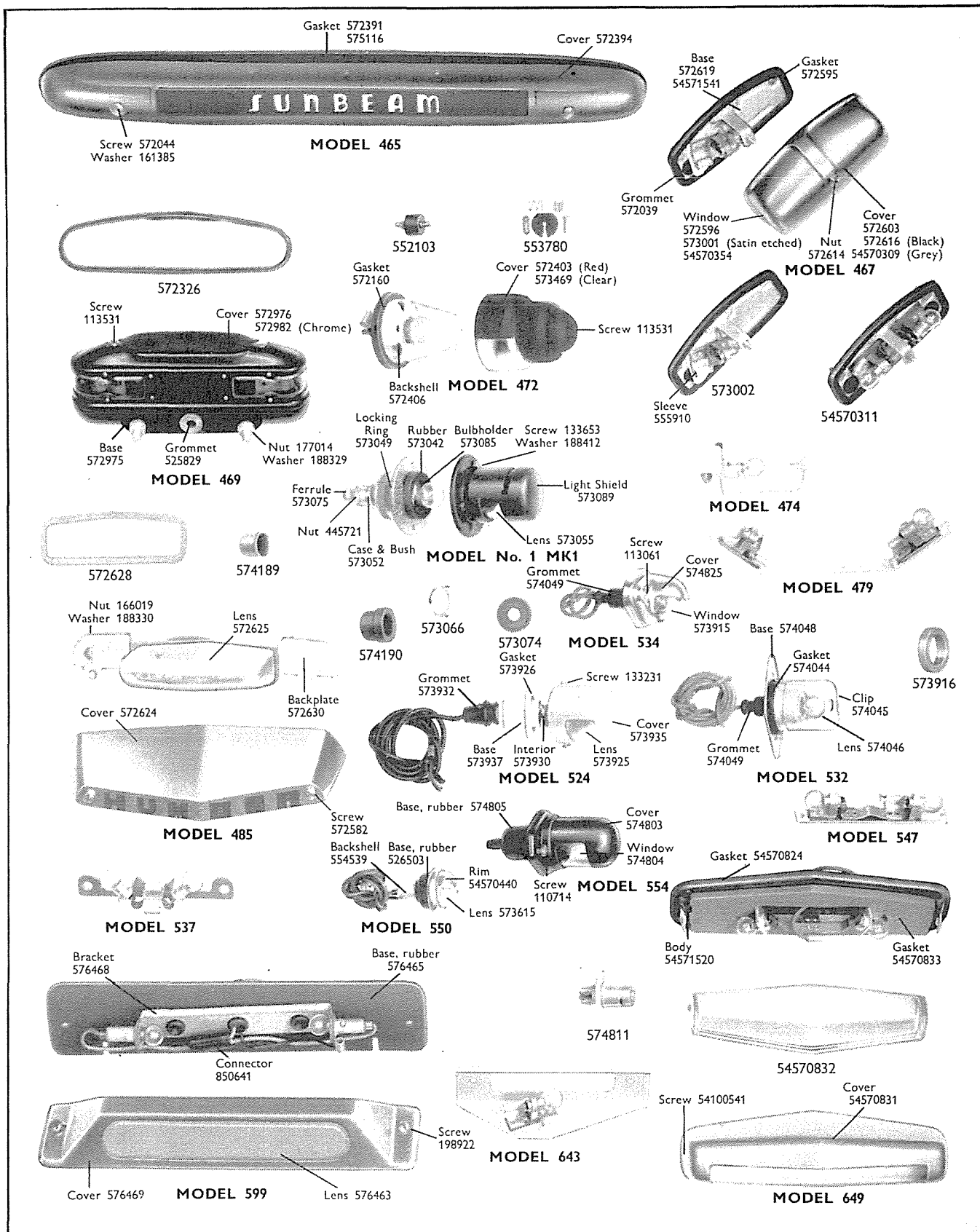

For detailed spare parts, see pages K11-K13

NUMBER PLATE LAMPS

(including Number Plate and Boot Lamps)

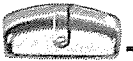

DETAILED SPARE PARTS

Part No.	53189B
Model	No. 1
Finish	Mk. 1
Replaced by (see footnote)	Primer
Replaced by (see footnote)	—
§Shield assembly, light	573089
§Screw, light shield fixing	133653
Washer, fixing screw	188412
§Glass	573055
§Gasket, lens seating	573053
Nut, union, cable entry	445721
Ferrule, cable entry	573075
Ring assembly, locking	573049
Case and bush assembly	573052
§Mounting, rubber, rear	574190
Cup, adaptor	574189
Washer, rubber	573074
Bulb holder assembly	573085
§ Interior, bulb holder	552103
§Bulb, 26 volt	156
Ring, earthing, bulb holder	573066
§Mounting, rubber, earthing ring	573042

Part No.	52405B	†52463A	53093A/J	A53093A/J
Model	550	550	467-2	467-2
Finish	C.P.R.	C.P.R.	Chromium	Chromium
Replaced by (see footnote)	—	(52405)	—	—
§Rim or door	54570440	54570440	—	—
§Cover	—	—	572603	572603
§Screw, cover or lens fixing	—	—	—	—
Washer, screw retaining	—	—	—	—
Clip, spring, lens cover retaining	—	—	—	—
§Glass	573615	573615	—	—
§Window	—	—	572596	572596
§Gasket, lens or window seating	—	—	572595	572595
§Bulb holder	—	—	—	—
§Interior, bulb holder	553780	553780	—	—
Backshell or shell, bulb holder	554539	554539	—	—
§Bulb, number plate	989	989	222	988
Base	—	—	572619	572619
§Body or base, rubber	526503	526503	—	—
Screw, body fixing or nut	—	—	—	—
§Gasket, base seating or cover	—	—	—	—
§Sleeve, terminal	—	—	—	—
§Grommet, cable	—	—	572039	572039
Bung, rubber	—	—	—	—
Connector, cable	—	—	—	—
Nut, lamp fixing	—	—	—	—
Washer, lamp fixing	—	—	—	—
§Sundry parts, set	—	—	572588	572588

Part No.	53101E/J	†53104B	53107A	†53108A	53109A	†53110A	†53112B	53121A	53135A
Model	467-2	465	474	474	474	474	465	479	485
Finish	Black	Chromium	—	—	—	—	Chromium	—	Chromium
Replaced by (see footnote)	—	(53277)	(53109)	(53109)	—	(53109)	(53277)	—	—
§Rim or door	—	—	—	—	—	—	—	—	—
§Cover	572616	572394	—	—	—	—	572394	—	572624
§Screw, cover or lens fixing	—	572044	—	—	—	—	572044	—	572582
Washer, screw retaining	—	161385	—	—	—	—	161385	—	161385
§Lens	—	—	—	—	—	—	—	—	—
§Window	572596	—	—	—	—	—	—	—	572625
§Gasket, lens or window seating	572595	—	—	—	—	—	—	—	572628
§Bulb holder	—	—	—	—	—	—	—	—	—
§Interior, bulb holder	—	553780	553780	553780	553780	553780	553780	—	—
Backshell or shell, bulb holder	—	—	—	—	—	—	—	—	‡572630
§Bulb, number plate	222	222	989	989	989	989	222	989	222
Base	572619	—	—	—	—	—	—	—	—
§Body or base, rubber	—	—	—	—	—	—	—	—	—
Screw, body fixing or nut	—	—	—	—	—	—	—	—	—
§Gasket, base seating or cover	—	572391	—	—	—	—	572391	—	—
§Sleeve, terminal	—	—	188818	188818	188818	188818	—	188818	188818
§Grommet, cable	572039	—	—	—	—	—	—	—	572039
Bung, rubber	—	—	—	—	—	—	—	—	—
Connector, cable	—	—	—	—	—	—	—	—	—
Nut, lamp fixing	—	166019	—	—	—	—	166019	—	166019
Washer, lamp fixing	—	188330	—	—	—	—	188330	—	188330
§Sundry parts, set	572588	—	—	—	—	—	—	—	—

For illustrations, see page K10

Note. For replacement lamp spare parts, see appropriate column under part number † When ordering, quote part number shown in brackets
 ‡ Backplate § Recommended spares for stock ¶ 2 off C.P.R. . . . Chromium plated rim

continued

NUMBER PLATE LAMPS

(including Number Plate and Boot Lamps)



DETAILED SPARE PARTS

Part No.	53164D	53171B	†53186A	53224A	†53266E	†53276A	53277A	53278B
Model	467	469	472	472	524	465	465	532
Finish	Chromium	Black	—	—	Black	Chromium	Chromium	—
Replaced by (see footnote)	—	—	(53224)	—	(53502)	(53277)	—	—
(1) §Rim or door	—	—	—	—	—	—	—	—
(2) §Cover	572603	572976	—	—	573935	572394	572394	—
(3) §Screw, cover fixing	—	113531	113531	113531	133231	572044	572044	—
(4) Washer, screw retaining	161385	161385	161385	161385	—	161385	161385	—
(5) Clip, spring, lens cover	—	—	—	—	—	—	—	574045
(6) §Lens	—	—	572403	573469	573925	—	—	574046
(7) §Window	573001	—	—	—	—	—	—	—
(8) §Gasket, lens or window seating	572595	—	572160	572160	573926	—	—	574044
(9) §Bulb holder	—	—	—	—	—	—	—	—
(10) §Interior, bulb holder	—	—	552103	552103	573930	553780	553780	553780
(11) Backshell or shell, bulb holder	—	—	572406	572406	—	—	—	—
(12) §Bulb, number plate	989	‡222	207	207	207	‡222	‡222	989
(13) Base	—	572975	—	—	573937	—	—	574048
(14) §Body or base, rubber	—	—	—	—	—	—	—	—
(15) Screw, body fixing or nut	—	—	—	—	—	—	—	—
(16) §Gasket, base seating or cover	—	572326	—	—	—	575116	572391	—
(17) §Sleeve, terminal	555910	188818	—	—	—	—	—	—
(18) §Grommet, cable	572039	—	—	—	573932	—	—	574049
(19) Bung, rubber	—	525829	—	—	—	—	—	—
(20) Connector, cable	—	—	—	—	—	—	—	—
(21) Nut, lamp fixing	572614	177014	—	—	—	166019	166019	—
(22) Washer, lamp fixing nut	—	188329	—	—	—	188330	188330	—
(23) §Sundry parts, set	—	—	—	—	—	—	—	—

Part No.	53518A	53595A/F	†53602A	53630A	†53633A	†53650A/B	53705A	53763A
Model	534	599	554	532	534	467-2	534	534
Finish	Chromium	Chromium	Black	Chromium	Chromium	Primer	—	—
Replaced by (see footnote)	—	—	(53343)	—	(53705)	(53101)	—	—
(1) §Rim or door	—	—	—	—	—	—	—	—
(2) §Cover	574825	576469	574803	—	574825	572616	574825	574825
(3) §Screw, cover fixing	113061	198922	—	—	113061	—	113061	113061
(4) Washer, screw retaining	161385	161385	—	—	161385	—	161385	161385
(5) Clip, spring, lens cover	—	—	—	574045	—	—	—	—
(6) §Lens	—	576463	—	574046	—	—	—	—
(7) §Window	573915	—	574804	—	573915	572596	573915	573915
(8) §Gasket, lens or window seating	573916	—	—	574044	573916	572595	573916	573916
(9) §Bulb holder	—	576468	—	—	—	—	—	—
(10) §Interior, bulb holder	553780	553780	574811	553780	553780	—	553780	553780
(11) Backshell or shell, bulb holder	—	—	—	—	—	—	—	—
(12) §Bulb, number plate	222	‡989	209	989	222	222	222	222
(13) Base	—	—	—	574048	—	572619	—	—
(14) §Body or base, rubber	—	576465	—	—	—	—	—	—
(15) Screw, body fixing or nut	—	—	—	—	—	—	—	—
(16) §Gasket, base seating or cover	—	—	574805	—	—	—	—	—
(17) §Sleeve, terminal	555910	555910	—	—	555910	—	555910	555910
(18) §Grommet, cable	574049	—	—	574049	574049	572039	574049	574049
(19) Bung, rubber	—	—	—	—	—	—	—	—
(20) Connector, cable	—	850641	—	—	—	—	—	—
(21) Nut, lamp fixing	—	—	—	—	—	—	—	—
(22) Washer, lamp fixing nut	—	—	—	—	—	—	—	—
(23) §Sundry parts, set	—	—	—	—	—	572588	—	—

For illustrations, see page K10

Note. For replacement lamp spare parts, see appropriate column under part number
 ‡ 2 off § Recommended spares for stock || Bracket, with bulb holder † When ordering, quote part number shown in brackets
 C.P.R. . . Chromium plated rim

NUMBER PLATE LAMPS

(including Number Plate and Boot Lamps)



DETAILED SPARE PARTS

	53291B 537 — —	53308A 543 Chromium —	53314B/E 547 — —	53320A/B 467-2 Black —	53343A 554 Black —	53346A 554 Black —	†53348B 534 Chromium (53518)	53374A/B 467-2 Black —	53388A/B 467-2 Chromium —	53502B/D 524 Chromium —
—	—	—	—	—	—	—	—	—	—	— (1)
—	—	574303	—	572616	574803	574803	574825	572616	572603	573935 (2)
—	—	133061	—	—	110714	110714	113061	—	—	113231 (3)
—	—	161385	—	161385	—	—	161385	—	161385	— (4)
—	—	—	—	—	—	—	—	—	—	— (5)
—	—	574311	—	—	—	—	—	—	—	— (6)
—	—	‡574310	—	572596	574804	574804	573915	572596	572596	573925 (7)
—	—	—	—	572595	—	—	573916	572595	572595	573926 (8)
—	—	—	—	—	574811	574811	—	—	—	— (9)
—	—	—	—	—	—	—	553780	—	—	573930 (10)
—	—	574308	—	—	—	—	—	—	—	— (11)
—	¶989	¶222	¶222	222	209	150	222	222	222	207 (12)
—	—	—	—	573002	—	—	—	—	573002	573937 (13)
—	—	574309	—	—	—	—	—	—	—	— (14)
—	—	—	—	572614	—	—	—	—	572614	— (15)
—	—	—	—	—	574805	574805	—	—	—	— (16)
—	—	—	188818	555910	—	—	555910	—	555910	— (17)
—	—	—	—	572039	—	—	574049	572039	572039	573932 (18)
—	—	—	—	—	—	—	—	—	—	— (19)
—	—	—	—	—	—	—	—	—	—	— (20)
—	—	166019	—	—	—	—	—	—	—	— (21)
—	—	188330	—	—	—	—	—	—	—	— (22)
—	—	—	—	—	—	—	—	572588	—	— (23)

	53766A/E 467 Grey Primer —	53786A/B 643 — —	53814A 649 Chromium —	53822A 534 — —	53826A 532 — —	53836A/B 467 Chromium —	53837A/B 467 Black —	53876A 467-2 Black —	53905A 469 Chromium —
—	—	—	—	—	—	—	—	—	— (1)
54570309	—	—	54570831	574825	—	572603	572616	572616	572982 (2)
—	—	—	54100541	113061	—	—	—	—	113531 (3)
—	—	—	—	161385	—	—	—	—	161385 (4)
—	—	—	—	—	574045	—	—	—	— (5)
—	—	—	54570832	—	574046	—	—	—	— (6)
54570354	—	—	—	573915	—	54570354	54570354	572596	— (7)
54571498	—	—	54570833	573916	574044	572595	572595	572595	— (8)
—	—	—	—	—	—	—	—	—	— (9)
—	—	—	—	553780	553780	—	—	—	— (10)
—	—	—	—	—	—	—	—	—	— (11)
989	989	¶989	¶989	222	989	¶222	¶222	222	¶989 (12)
—	—	—	54571520	—	574048	54570311	54570311	54571541	54572157 (13)
—	—	—	—	—	—	—	—	—	— (14)
—	—	—	—	—	—	—	—	—	— (15)
—	—	—	54570824	—	—	—	—	—	572326 (16)
—	—	555910	555910	555910	—	—	—	—	188818 (17)
—	—	—	—	574049	574049	572039	572039	572039	— (18)
—	—	—	—	—	—	—	—	572040	572685 (19)
—	—	—	—	—	—	—	—	—	199001 (20)
—	—	—	—	—	—	—	—	—	177014 (21)
—	—	—	—	—	—	—	—	—	188329 (22)
572588	—	—	—	—	—	572588	572588	572588	— (23)

For illustrations, see page K10

† When ordering, quote part number shown in brackets ‡ Boot || Bracket, bulb holder ¶ 2 off C.P.R. ... Chromium plated rim



NUMBER PLATE AND REVERSE LAMPS

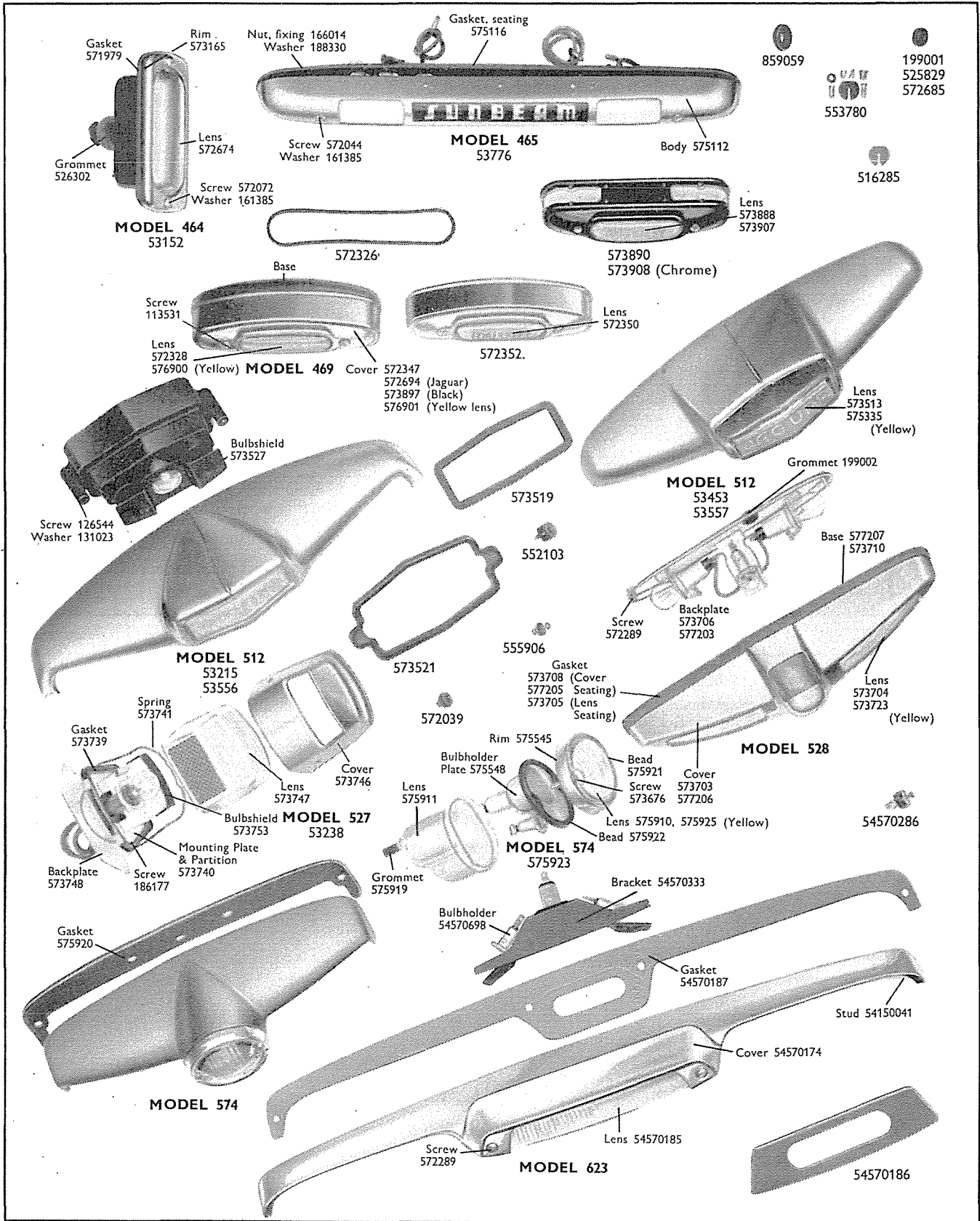

For detailed spare parts, see pages K15-K17

DETAILED SPARE PARTS

NUMBER PLATE AND REVERSE LAMPS

Part No.	53097D/E	53130D	53149D	53152F	†53159B	53161D	53215A	53238F	†53243A/F	†53255A	53258A
Model	469	469	469	464	469	469	512	527	528	512	469
Finish	Chromium	Chromium	Chromium	C.P.R.	Chromium	Chromium	Chromium	Chromium	Chromium	Chromium	Chromium
Replaced by (see footnote)	—	—	—	—	(53161)	—	—	—	(53603)	(53215)	—
§Rim or door	—	—	—	573165	—	—	—	—	—	—	—
§Cover	572347	572352	572694	—	572347	572347	—	573746	573703	—	572347
§Screw, cover or rim fixing	113531	113531	113531	572072	113531	113531	—	573743	—	—	113531
Washer, screw retaining	161385	161385	161385	161385	161385	161385	—	—	—	—	161385
Washer, shakeproof	188329	188329	188329	—	188329	188329	—	—	—	—	188329
§Lens, reverse	572328	572350	572328	572674	572328	572328	573513	573747	573704	573513	572328
§Lens, number plate	—	—	—	—	—	—	573513	573747	573704	573513	—
Spring, lens fixing	—	—	—	—	—	—	—	573741	—	—	—
§Gasket, cover or bulb shield seating	572326	572326	572326	571979	572326	572326	573521	—	573708	573521	572326
§Gasket, lens seating	—	—	—	—	—	—	573519	573739	573705	573519	—
§Gasket, number plate lens seating	—	—	—	—	—	—	—	—	—	—	—
§Mounting plate and partition	—	—	—	—	—	—	—	573740	—	—	—
Bracket, with bulb holder	—	—	—	—	—	—	—	—	573706	—	—
Screw, bulb shield or mounting plate fixing	—	—	—	—	—	—	126544	186137	572289	126544	—
Washer, retaining	—	—	—	—	—	—	131023	—	161385	131023	—
§Shield, bulb	—	—	—	—	—	—	573527	573753	—	573527	—
§Interior, bulb holder	—	—	—	552103	—	—	553780	555906	555906	553780	—
§Interior, reverse bulb holder	—	—	—	—	—	—	552103	552103	552103	552103	—
§Bulb, reverse	382	382	382	—	382	382	382	382	‡382	382	382
§Bulb, number plate	‡222	‡222	‡222	207	‡222	‡222	‡222	222	222	‡222	‡222
§Gasket, lamp seating	—	—	—	—	—	—	—	—	—	—	—
§Grommet, rubber, cable	—	—	199001	526302	199001	199001	—	572039	199002	—	525829
Washer, cable grip	—	—	—	—	—	—	—	—	—	—	—
Bung, rubber	525829	525829	—	—	572685	572685	—	—	—	—	—
§ Sleeve, terminal	188818	188818	188818	188818	188818	188818	188818	555910	555910	188818	188818
Base, backplate or body	572681	572681	—	—	572989	572989	—	573748	—	—	572995
Screw, base plate or bulb holder bracket fixing	—	—	—	—	—	—	126463	—	126444	126463	—
Screw, base plate or lamp fixing	—	—	—	—	—	—	—	186177	106501	—	—
Nut, back plate securing	—	—	—	—	—	—	—	166019	—	—	—
Washer, lock	—	—	—	—	—	—	185038	188330	188304	185038	—
Washer, base plate fixing screw retaining	—	—	—	—	—	—	—	—	185040	—	—
Nut, lamp fixing	177014	177014	177014	—	177014	177014	—	—	177036	—	177014
Stud, lamp fixing, long	—	—	—	—	—	—	—	—	—	—	—
Stud, lamp fixing, short	—	—	—	—	—	—	—	—	—	—	—

Note. For replacement lamp spare parts, see appropriate column under part number † When ordering, quote part number shown in brackets ‡ 2 off § Recommended spares for stock
 ‡ 3 off C.P.R. . . Chromium plated rim

K15

For illustrations see page K14

continued

53097 — 53258

DETAILED SPARE PARTS

K16

53275 — 53523

NUMBER PLATE AND REVERSE LAMPS

Part No.	53275A	53297A	53317A	53376E	53414A	†53434A	53452A	53453A	†53462A	53481E	†53523A
Model	469	469	469	465	469	469	574	512	469	528	469
Finish	Black	Chromium	Black	Chromium	Chromium	Chromium	C.P.R.	Chromium	Chromium	Chromium	Chromium
Replaced by (see footnote)	—	—	—	—	—	(53161)	—	—	(53097)	—	(53097)
§Rim or door	—	—	—	—	—	—	575545	—	—	—	—
§Cover	573890	572347	573897	—	573908	572347	—	—	572347	573703	572347
§Screw, cover or rim fixing	113531	113531	113531	—	113531	113531	573676	—	113531	—	113531
Washer, screw retaining	161385	161385	161385	161385	161385	161385	—	—	161385	—	161385
Washer, shakeproof	188470	188329	188470	188330	188470	188470	—	—	188329	—	188329
§Lens, reverse	573888	572328	572328	—	573907	572328	575910	573513	572328	573723	572328
§Lens, number plate	—	—	—	—	—	—	575911	573513	—	573723	—
Spring, lens fixing	—	—	—	—	—	—	—	—	—	—	—
§Gasket, cover or bulb shield seating	572326	572326	572326	—	572326	572326	—	573521	572326	573708	572326
§Gasket, lens seating	—	—	—	—	—	—	575921	573519	—	573705	—
§Gasket, number plate lens seating	—	—	—	—	—	—	575922	—	—	—	—
§Mounting plate and partition	—	—	—	—	—	—	—	—	—	—	—
Bracket, with bulb holder	—	—	—	—	—	—	575548	—	—	573706	—
Screw, bulb shield or mounting plate fixing	—	—	—	—	—	—	—	126544	—	572289	—
Washer, retaining	—	—	—	—	—	—	—	131023	—	161385	—
§Shield, bulb	—	—	—	—	—	—	—	573527	—	—	—
§Interior, bulb holder	—	—	—	553780	—	—	555906	553780	—	555906	—
§Interior, reverse bulb holder	—	—	—	—	—	—	552103	552103	—	552103	—
§Bulb, reverse	382	382	382	—	382	382	382	382	382	‡382	382
§Bulb, number plate	‡222	‡222	‡222	989	‡989	‡989	222	‡222	‡222	222	‡222
§Gasket, lamp seating	—	—	—	575116	—	—	575920	—	—	—	—
§Grommet, rubber, cable	199001	—	199001	859059	199001	199001	575919	—	—	199002	—
Washer, cable grip	—	—	—	516285	—	—	—	—	—	—	—
Bung, rubber	572685	525829	572685	—	572685	572685	—	—	525829	—	525829
§Sleeve, terminal	188818	188818	188818	188818	188818	188818	188818	188818	188818	555910	188818
Base, backplate or body	573894	572681	573894	575112	573894	573894	—	—	572681	—	572681
Screw, base plate, body or bulb holder bracket fixing	—	—	—	572044	—	—	—	126463	—	106501	—
Screw, base plate or lamp fixing	—	—	—	—	—	—	—	—	—	126444	—
Nut, backplate securing	—	—	—	—	—	—	—	—	—	—	—
Washer, lock	—	—	—	—	—	—	—	185038	—	185040	—
Washer, base plate fixing screw retaining	—	—	—	—	—	—	—	—	—	188304	—
Nut, lamp fixing	177014	177014	177014	166019	177014	177014	—	—	177014	177036	177014
Stud, lamp fixing, long	—	—	—	—	—	—	—	—	—	—	—
Stud, lamp fixing, short	—	—	—	—	—	—	—	—	—	—	—

Note. For replacement lamp spare parts, see appropriate column under part number . † When ordering, quote part number shown in brackets ‡ 2 off § Recommended spares for stock
 C.P.R. . . Chromium plated rim

For illustrations, see page K14

continued

DETAILED SPARE PARTS

Part No.	53546A	53551A	53556A	53557A	53558A	†53573A	53603A/B	53604A/B	53606A	53719A	575923
Model	574	469	512	512	574	469	528	528	469	623	574
Finish	Chromium	Chromium	Chromium	Chromium	Chromium	Chromium	Chromium	Chromium	Chromium	Chromium	C.P.R.
Replaced by (see footnote)	—	—	—	—	—	(53161)	—	—	—	—	—
§Rim or door	575545	—	—	—	575545	—	—	—	—	—	575545
§Cover	—	576901	—	—	—	572347	577206	577206	576901	54570174	—
§Screw, cover or rim fixing	573676	113531	—	—	573676	113531	—	—	113531	572289	573676
Washer, screw retaining	—	161385	—	—	—	161385	—	—	161385	—	—
Washer, shakeproof	—	188329	—	—	—	188329	**573711	**573711	188329	188330	—
§Lens, reverse	575910	576900	575335	575335	575925	572328	573704	573723	576900	54570185	575910
§Lens, number plate	575911	—	575335	575335	575911	—	573704	573723	—	—	575911
Spring, lens fixing	—	—	—	—	—	—	—	—	—	—	—
§Gasket, cover or bulb shield seating	—	572326	573521	573521	—	572326	577205	577205	572326	—	—
§Gasket, lens seating	575921	—	573519	573519	575921	—	573705	573705	—	54570186	575921
§Gasket, number plate lens seating	575922	—	—	—	575922	—	—	—	—	—	575922
§Mounting plate and partition	—	—	—	—	—	—	—	—	—	—	—
Bracket, with bulb holder	575548	—	—	—	575548	—	577203	577203	—	54570333	575548
Screw, bulb shield or mounting plate fixing	—	—	126544	126544	—	—	572289	572289	—	—	—
Washer, retaining	—	—	131023	131023	—	—	161385	161385	—	—	—
§Shield, bulb	—	—	573527	573527	—	—	—	—	—	—	—
§Interior, bulb holder	555906	—	553780	553780	555906	—	555906	555906	—	‡54570698	555906
§Interior, reverse bulb holder	552103	—	552103	552103	552103	—	552103	552103	—	54570286	552103
§Bulb, reverse	382	382	382	382	382	382	382	382	382	382	382
§Bulb, number plate	222	222	¶222	222	222	222	989	989	222	989	222
§Gasket, lamp seating	575920	—	—	—	575920	—	—	—	—	54570187	—
§Grommet, rubber, cable	575919	199001	—	—	575919	199001	199002	199002	—	—	575919
Washer, cable grip	—	—	—	—	—	—	—	—	—	—	—
Bung, rubber	—	572685	—	—	—	572685	—	—	525829	—	—
§Sleeve, terminal	188818	188818	188818	188818	188818	188818	555910	555910	181818	555910	555910
Base, backplate or body	—	572989	—	—	—	—	577207	577207	572681	—	—
Screw, bulb holder bracket fixing	—	—	126463	126463	—	—	—	—	—	—	—
Screw, base plate or lamp fixing	—	—	—	—	—	—	—	—	—	—	—
Nut, backplate securing	—	—	—	—	—	—	—	—	—	—	—
Washer, lock	—	—	185038	185038	—	—	188304	188304	—	—	—
Washer, base plate fixing screw retaining	—	—	—	—	—	—	185040	185040	—	—	—
Nut, lamp fixing	—	177014	—	—	—	177014	166019	166019	177014	—	—
Stud, lamp fixing, long	—	—	—	—	—	—	573859	573859	—	54150041	—
Stud, lamp fixing, short	—	—	—	—	—	—	577200	577200	—	—	—

NUMBER PLATE AND REVERSE LAMPS

53546 — 575923

Note. For replacement lamp spare parts, see appropriate column under part number
 † 3 off ** Spacer C.P.R. . . Chromium plated rim ‡ When ordering, quote part number shown in brackets ‡ Bulb holder § Recommended spares for stock || 2 off

K17

For illustrations, see page K14

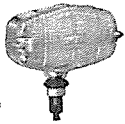

REVERSE LAMPS

DETAILED SPARE PARTS

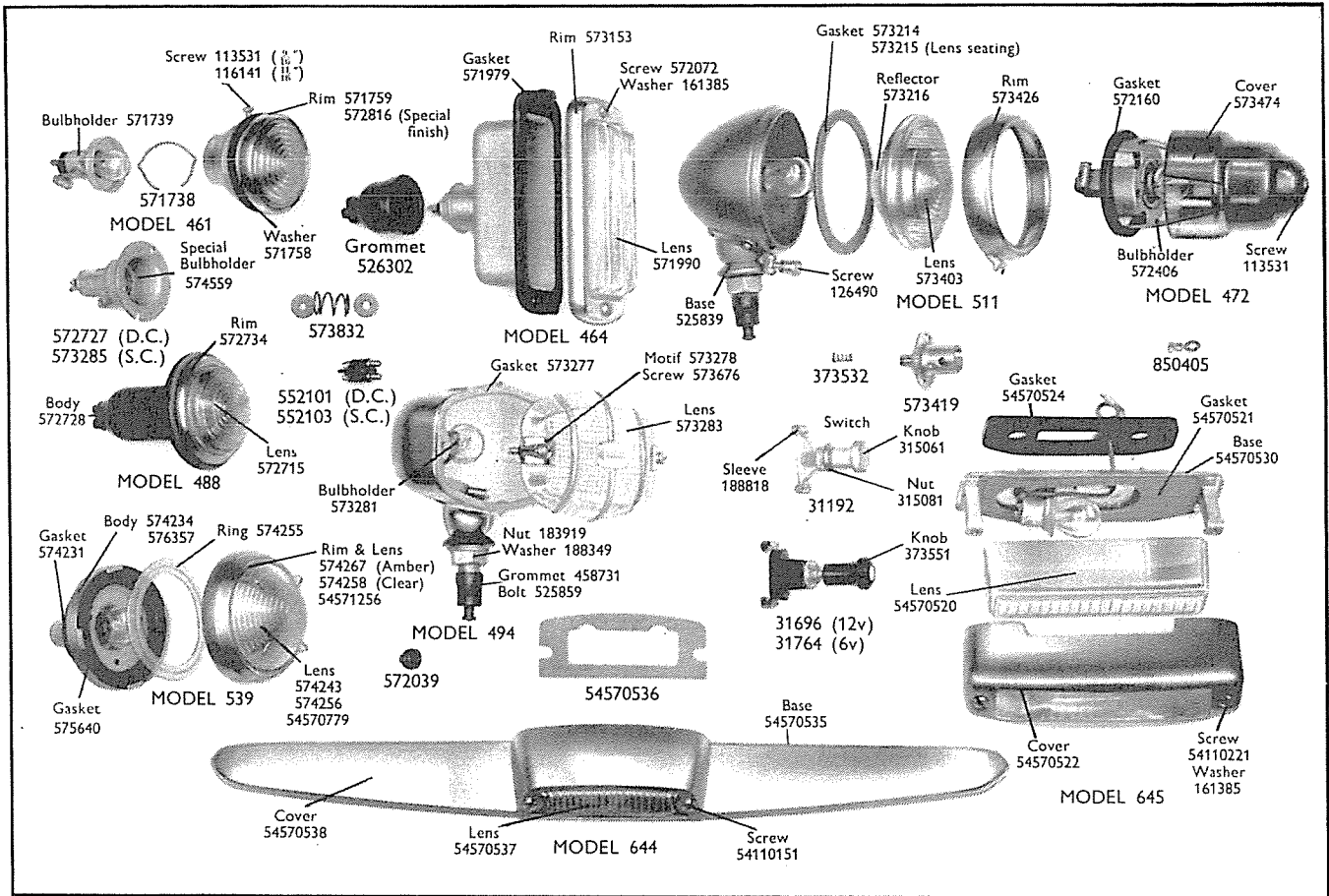

Part No.	52120D	†52246B/D	52285B/D	52308A	52309A/B	52503A	53128E/F	53209D	53210F/H	53223A
Model	461-1	488	488	539	539	539	464	494	488	472
Finish	C.P.R.	C.P.R.	C.P.R.	C.P.R.	C.P.R.	C.P.R.	C.P.R.	Chromium (058720, 6v.) (058721, 12v.)	C.P.R.	—
Replaced by (see footnote)	—	(52285)	—	—	—	—	—	—	—	—
§Rim or door	‡571759	572734	572734	‡574258	‡574267	‡574258	573153	—	572734	—
§Screw or nut, fixing	113531	—	—	—	—	—	572072	573676	—	¶113531
§Washer, screw retaining	—	—	—	—	—	—	161385	161385	—	161385
§Cover	—	—	—	—	—	—	—	—	—	573474
§Lens or glass	—	572715	572715	574243	574256	574243	571990	573283	572715	—
§Gasket, lens seating	—	—	—	575640	575640	575640	571979	573277	—	573160
§Gasket, body seating	—	—	—	574231	574231	574231	—	—	—	—
§Ring, sliding	—	—	—	574255	574255	574255	—	—	—	—
§Washer, shakeproof	—	—	—	—	—	—	—	188349	—	—
§Sleeve, terminal	188818	555910	555910	—	—	—	555910	555910	555910	—
§Bulb	207	382	382	382	382	382	382	382	382	382
§Nut, lamp fixing	—	—	—	—	—	—	—	183919	—	—
§Body	—	575003	575003	576357	576357	576357	—	—	575003	—
§Washer, rubber	571758	—	—	—	—	—	—	—	—	—
§Grommet, rubber	—	—	—	—	—	—	576401	458731	—	—
§Interior	552103	552103	552103	573832	573832	573832	552103	—	552103	552103
§Bulb holder	571739	573285	573285	—	—	—	—	573281	573285	572406
§Backshell	—	—	—	—	—	—	—	—	—	—
§Ring, adaptor shell fixing	571738	—	—	—	—	—	—	—	—	—
§Reflector	—	—	—	—	—	—	—	—	—	—
§Motif	—	—	—	—	—	—	—	573278	—	—
§Base, lamp seating	—	—	—	—	—	—	—	525839	—	—
§Bolt, lamp fixing	—	—	—	—	—	—	—	525859	—	—
§Switch	—	—	—	—	—	—	—	—	—	—
§Knob	—	—	—	—	—	—	—	—	—	—
§Bulb	—	—	—	—	—	—	—	—	—	—
§Spring	—	—	—	—	—	—	—	—	—	—
§Nut, fixing	—	—	—	—	—	—	—	—	—	—

Note. For replacement lamp spare parts, see appropriate column under part number † When ordering, quote part number shown in brackets ‡ With lens
 § Recommended spares for stock || Lens fixing ¶ Cover fixing C.P.R. . . Chromium plated rim

REVERSE LAMPS

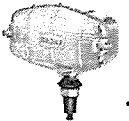

DETAILED SPARE PARTS

Part No.	53307A	53378A	53412B	53501A/B	53515A	53787A/D	53789A	†052671
Model	461	539	464	539	461-1	644	645	494
Finish	C.P.R.	C.P.R.	C.P.R.	C.P.R.	C.P.R.	Chromium	Chromium	Chromium
Replaced by (see footnote)	—	—	—	—	—	—	—	(058720)
§ Rim or door	‡572816	‡574258	573153	‡54571256	‡572816	—	—	—
§ Screw or nut, fixing	116141	—	572072	—	116141	¶54110151	¶54110221	¶573676
Washer, screw retaining	—	—	161385	—	—	—	161385	161385
§ Cover	—	—	—	—	—	54570538	54570522	—
§ Lens or glass	—	574243	571990	54570779	—	54570537	54570520	573283
§ Gasket, lens seating	—	575640	571979	575640	—	54570536	54570521	573277
§ Gasket, body seating	—	574231	—	574231	—	—	54570524	—
§ Ring, sliding	—	574255	—	574255	—	—	—	—
Washer, shakeproof	—	—	—	—	—	—	—	188349
§ Sleeve, terminal	188818	—	555910	—	188818	555910	555910	555910
§ Bulb	382	382	382	382	382	382	382	106
Nut, lamp fixing	—	—	—	—	—	—	—	183919
Body	—	574234	—	576357	—	—	—	—
Washer, rubber	571758	—	—	—	571758	—	—	—
§ Grommet, rubber	—	—	526302	—	—	572039	—	458731
§ Interior	552103	573832	552103	573832	552103	—	—	—
§ Bulb holder	571739	—	—	—	571739	—	—	573281
Backshell	—	—	—	—	—	—	—	—
Ring, adaptor shell fixing	571738	—	—	—	571738	—	—	—
§ Reflector	—	—	—	—	—	—	—	—
§ Motif	—	—	—	—	—	—	—	573278
Base, lamp seating	—	—	—	—	—	54570535	54570530	525839
Bolt, lamp fixing	—	—	—	—	—	—	—	525859
§ Switch	—	—	—	—	—	—	—	31192
§ Knob	—	—	—	—	—	—	—	315061
§ Bulb	—	—	—	—	—	—	—	—
Spring	—	—	—	—	—	—	—	—
Nut, fixing	—	—	—	—	—	—	—	315081
§ Sleeve, terminal	—	—	—	—	—	—	—	188818

Part No.	†052672	†052707	†052708	052993	058720	058721	058722	058723
Model	494	511	511	548	494	494	511	511
Finish	Chromium	Poly-chromatic beige	Poly-chromatic beige	Kit of parts	Chromium (6 volt)	Chromium (12 volt)	Poly-chromatic beige	Poly-chromatic beige
Replaced by (see footnote)	(058721)	(058723)	(058722)	—	—	—	—	—
§ Rim or door	—	573426	573426	—	—	—	573426	573426
§ Screw or nut, fixing	¶573676	126490	126490	—	¶573676	¶573676	126490	126490
Washer, screw retaining	161385	161385	161385	—	161385	161385	161385	161385
§ Cover	—	—	—	—	—	—	—	—
§ Lens	573283	573403	573403	—	573283	573283	573403	573403
§ Gasket, lens seating	573277	573215	573215	—	573277	573277	573215	573215
§ Gasket, body seating	—	§573214	§573214	—	—	—	§573214	§573214
§ Ring, sliding	—	—	—	—	—	—	—	—
Washer, shakeproof	188349	188349	188349	—	188349	188349	188349	188349
§ Sleeve, terminal	555910	—	—	—	555910	555910	—	—
§ Bulb	382	382	106	382	317	382	317	382
Nut, lamp fixing	183919	183919	183919	—	183919	183919	183919	183919
Washer, rubber	—	—	—	—	—	—	—	—
§ Grommet, rubber	458731	458731	458731	—	458731	458731	458731	458731
§ Interior	—	—	—	573832	—	—	—	—
§ Bulb holder	573281	573419	573419	574559	573281	573281	573419	573419
Backshell	—	—	—	—	—	—	—	—
Ring, adaptor shell fixing	—	**850405	**850405	—	—	—	**850405	**850405
§ Reflector	—	573216	573216	—	—	—	573216	573216
§ Motif	573278	—	—	—	573278	573278	—	—
Base, lamp seating	525839	525839	525839	—	525839	525839	525839	525839
Bolt, lamp fixing	525859	525859	525859	—	525859	525859	525859	525859
§ Switch	31192	31192	31192	31281	31764	31696	31764	31696
§ Knob	315061	315061	315061	—	373551	373551	373551	373551
§ Bulb	—	—	—	—	282	281	282	281
Spring	—	—	—	—	373532	373532	373532	373532
Nut, fixing	315081	315081	315081	—	180816	180816	180816	180816
§ Sleeve, terminal	188818	188818	188818	—	188818	188818	188818	188818

Note. For replacement lamp spare parts, see appropriate column under part number † When ordering, quote part number shown in brackets ‡ With lens
 § Recommended spares for stock ¶ Cover fixing ¶ Lens fixing § Reflector to body gasket ** Terminal earth clip C.P.R. . . . Chromium plated rim

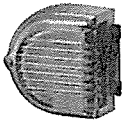

REVERSE, TAIL AND NUMBER PLATE LAMPS AND STOP LAMPS

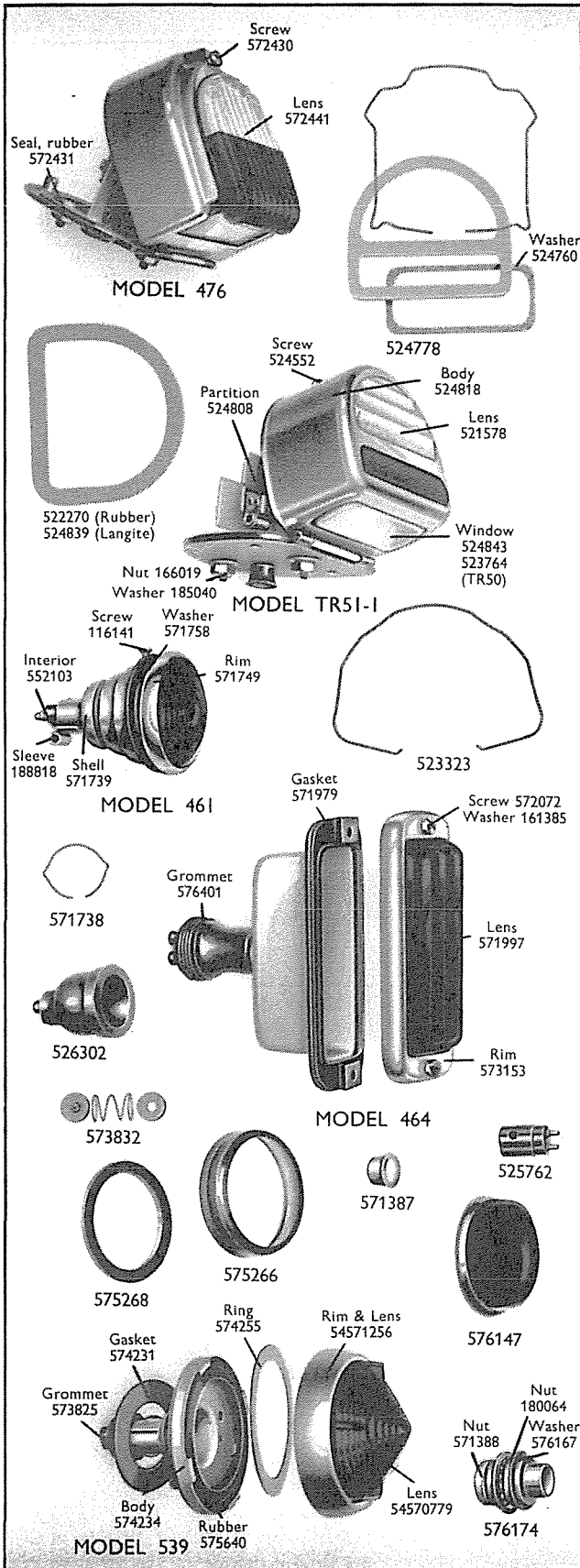

REVERSE, TAIL AND NUMBER PLATE LAMPS

Part No.	53032B	53035B	53116A	525133
Model	TR51-I	TR51-I	476	TR50C
Finish	Chrom-ium	Chrom-ium	Chrom-ium	Chrom-ium
§Seal, rubber	—	—	572431	—
§Lens, reverse tail	521578	521578	572441	521578
§Lens or window	524843	524843	—	523764
§Sleeve, terminal	188818	188818	188818	188818
§Bulb, single contact	207	207	382	207
§Bulb, reverse lamp	No. 1	No. 1	989	No. 1
§Nut, lamp fixing	166019	166019	166019	166019
Washer, spring	185040	185040	185040	185040
Washer, langite	—	—	—	524839
Screw, body fixing	524552	524552	572430	524552
Spring, lens fixing	—	—	—	523810
Washer, body seating	522270	522270	—	522270
Partition	524808	524808	—	—
Body	524818	524818	—	—
Fixing parts, set	524778	524778	—	—
Washer, tail lens	524839	524839	—	—
Washer, number plate lens	524760	524760	—	—
Washer, screw retain- ing	161385	161385	—	—

STOP LAMPS

Part No.	53113D	53207B/E	‡53315A/F
Model	461	464	488
Finish	C.P.R.	C.P.R.	C.P.R.
§Rim or door	571749	573153	572734
§Screw, rim fixing	116141	572072	—
Washer, screw retaining	—	161385	—
§Lens or glass	—	571997	54570664
§Gasket, lens seating	—	571979	—
Body, with bulb holder	—	—	573285
§Interior, bulb holder	552103	552103	552103
§Sleeve, terminal	188818	555910	555910
§Bulb	207	382	221
Washer, rubber	571758	—	—
§Grogmet, rubber	—	576401	—
§Gasket, body seating	—	—	‡575003
Ring, adaptor shell fixing	571738	—	—
Shell, bulb holder	571739	—	—

Part No.	‡53437A	‡53600A/E	53686A/E
Model	AT202	594	539
Finish	—	C.P.R.	C.P.R.
§Rim or door	575266	572734	§54571256
§Lens or glass	576147	54571112	54570779
§Gasket, lens seating	575268	—	575640
§Ring, sliding	—	—	574255
Body, with bulb holder	—	576986	574234
§Interior, bulb holder	525762	552103	573832
§Sleeve, terminal	—	555910	—
§Bulb	335	382	382
§Grogmet, rubber	—	—	573825
§Gasket, body seating	—	‡576105	574231
Shell, bulb holder	576174	—	—
Nut, coupling	571388	—	—
Shell, cable cover	571387	—	—
Washer, cable cover shell	805040	—	—
Nut, lamp and adaptor fixing	180064	—	—
Washer, adaptor fixing nut	576167	—	—

† For illustrations, see page K52 ‡ Body § Recommended spares for stock ¶ Repair only § Lens and rim C.P.R. . . Chromium plated rim

STOP TAIL AND NUMBER PLATE LAMPS



MODELS 564 and VP64

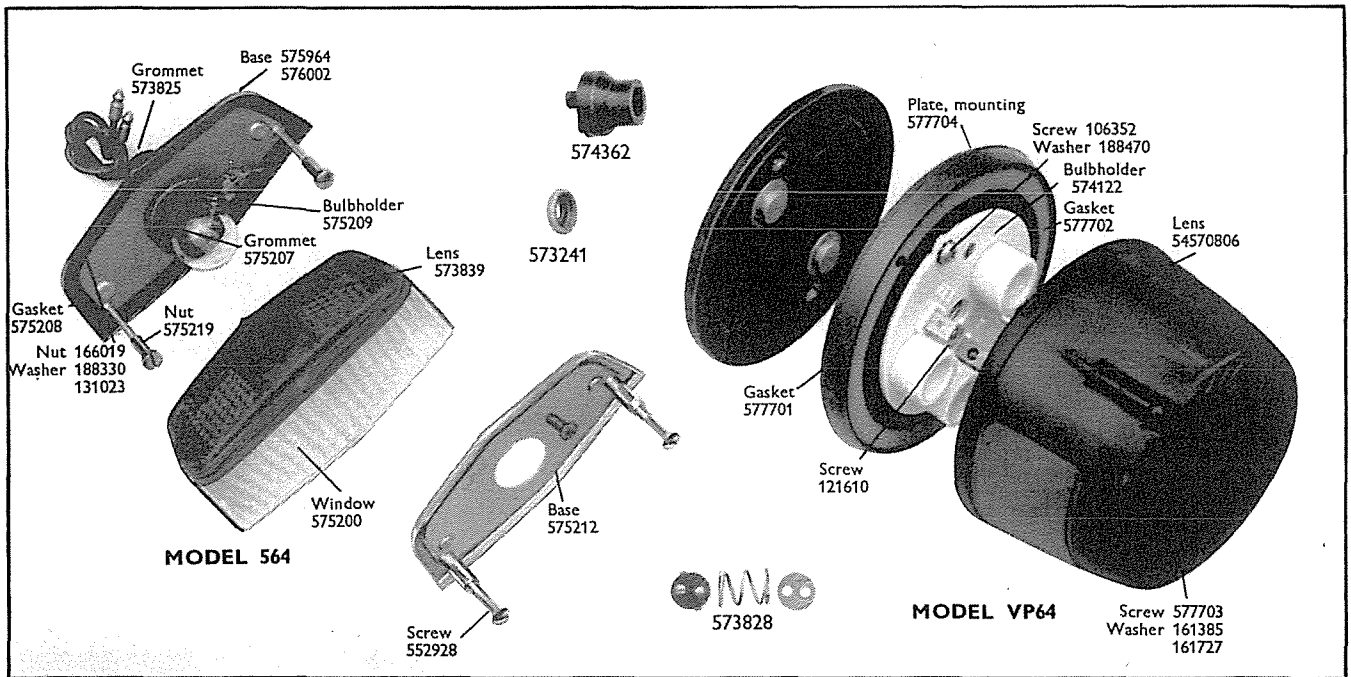

Part No.	53394A	53394B	53432A	53432B	53454B	‡53699A
Model	564	564	564	564	564	VP64
§Lens	573839	573839	573839	573839	573839	‡54570806
§Window	575200	575200	575200	575200	575200	—
§Nut, barrel, lens fixing	—	575219	—	575219	575219	—
§Screw, lens fixing	552928	—	552928	—	—	‡577703
Washer, screw retaining	—	—	—	—	—	161385
Washer, leatheroid	—	—	—	—	—	161727
§Gasket, lens seating	575208	575208	575208	575208	575208	‡577702
Screw, bulb holder fixing	—	—	—	—	—	106352
Washer, shakeproof, bulb holder screw	—	—	—	—	—	188470
§Bulb holder	575209	575209	575209	575209	575209	574122
Base	575212	576002	575212	576002	575964	—
§Interior, bulb holder	573828	573828	573828	573828	573828	—
§Bulb	352	352	384	384	380	—
§Screw, grub, terminal	—	—	—	—	—	121610
Plate, mounting	—	—	—	—	—	‡577704
§Gasket, base seating	—	—	—	—	—	‡577701
§Grommet, cable	573825	573825	573825	573825	573825	—
§Nut, lamp fixing	166019	166019	166019	166019	166019	170014
Washer, shakeproof	188330	188330	188330	188330	188330	188470
Washer, spacer, fixing bolt	131023	131023	131023	131023	131023	—
Bush, fixing bolt	—	—	—	—	—	‡573241
Grommet, bulb holder	575207	575207	575207	575207	575207	574362

‡ Serviced by C.A.V. § Recommended spares for stock



STOP TAIL AND NUMBER PLATE LAMPS

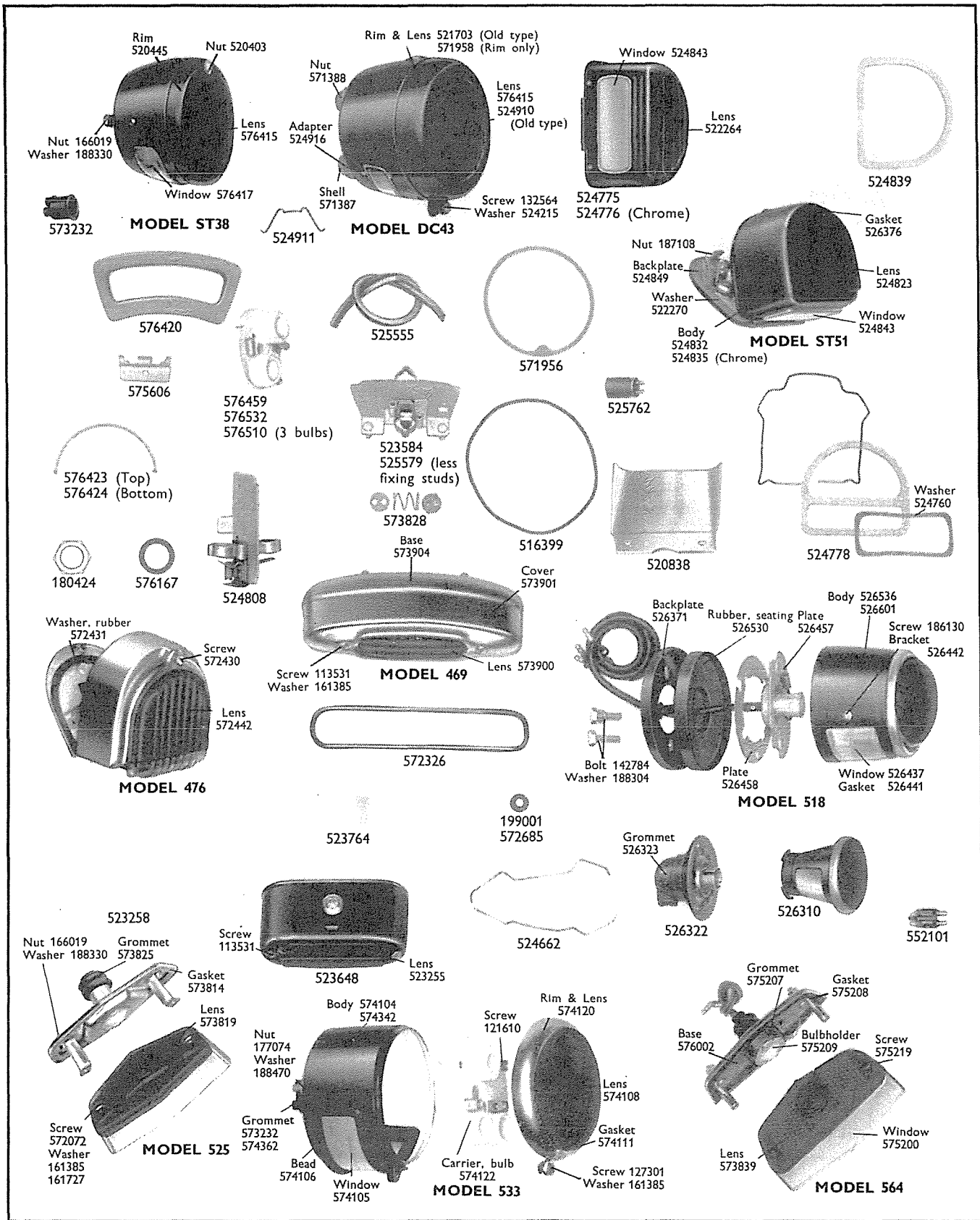

For detailed spare parts, see pages K23-K27

DETAILED SPARE PARTS

Part No.	†53008B	†A53008B	†53027B	†53028B	†53029A	A53029A	†53031D	†A53031D	†53060A	†A53060A	†53062B
Model	ST38C	ST38C	ST51-1	ST38D	ST51	ST51	ST52	ST52	ST51	ST51	ST38C
Finish	Black	Black	Chromium	Chromium	Chromium	Chromium	Black	Black	Black	Black	Black
Replaced by (see footnote)	(53440)	(53439)	(53392)	(53440)	(53392)	—	(53244)	(53394)	(53390)	(53389)	(53440)
§Rim or door	520445	520445	—	520445	—	—	—	—	—	—	520445
§Screw or nut, fixing	520403	520403	—	520403	—	—	—	—	—	—	520403
Washer, screw retaining	161385	161385	524215	161385	161385	161385	161385	161385	161385	161385	161385
§Gasket	525555	525555	524760	525555	524760	524760	—	—	524760	524760	525555
§Lens, stop tail	576415	576415	522264	576415	522264	522264	523255	523255	522264	522264	576415
§Lens or window, number plate	—	—	524843	—	524843	524843	—	—	524843	524843	—
§Partition or mounting platform	523584	523584	524808	523584	—	—	—	—	—	—	523584
Nut, partition body, contact or platform fixing	166019	166019	—	166019	—	—	—	—	—	—	166019
Washer, shakeproof	188330	188330	188330	188330	—	—	—	—	—	—	188330
§Sleeve, terminal	188818	188818	188818	188818	188818	188818	188818	188818	188818	188818	188818
Terminal, earth or screw	523571	523571	—	523571	—	—	—	—	—	—	523571
Bulb	207	205	207	207	207	200	207	200	207	205	207
Nut, lamp fixing or coupling	—	—	166019	166019	166019	166019	166019	166019	166019	166019	166019
Washer, spring or shakeproof	188330	188330	—	188330	185040	185040	188330	188330	185040	185040	188330
Washer, langite or leatheroid	—	—	—	—	—	—	523258	523258	—	—	—
Body	—	—	524776	—	524776	524776	523648	523648	524775	524775	—
Screw, body fixing	—	—	524552	—	524552	524552	113531	113531	524552	524552	—
§Gasket, rubber	—	—	—	—	—	—	—	—	—	—	—
Fixing parts, set	—	—	524778	—	524778	524778	—	—	524778	524778	—
§Springs, lens fixing	—	—	—	—	—	—	524662	524662	—	—	—
Washer, body seating	—	—	522270	—	522270	522270	—	—	522270	522270	—
§Grommet, rubber	—	—	—	—	—	—	—	—	—	—	—
Shell cable cover	—	—	—	—	—	—	—	—	—	—	—
§Interior or contact	—	—	—	—	—	—	—	—	—	—	—
§Bulb holder	—	—	—	—	—	—	—	—	—	—	—
Washer, tail lens	—	—	524839	—	524839	524839	—	—	524839	524839	—
Clamp, window fixing	—	—	—	—	—	—	—	—	—	—	—
Screw, clamp or contact assembly fixing	—	—	—	—	—	—	—	—	—	—	—
Plate, retaining or friction	—	—	—	—	—	—	—	—	—	—	—
Backplate or bracket, spring clips	—	—	—	—	—	—	—	—	—	—	—
Bolt, backplate or bracket fixing	—	—	—	—	—	—	—	—	—	—	—
Body, adaptor	—	—	—	—	—	—	—	—	—	—	—
Nut, adaptor fixing	—	—	—	—	—	—	—	—	—	—	—
Carrier, bulb	—	—	—	—	—	—	—	—	—	—	—
Nut, bulb carrier fixing or screw	—	—	—	—	—	—	—	—	—	—	—

STOP TAIL AND NUMBER PLATE LAMPS

53008 — 53062

Note. For replacement lamp spare parts, see appropriate column under part number † When ordering, quote part number shown in brackets § Recommended spares for stock

K23

For illustrations, see page K22

continued

DETAILED SPARE PARTS

K24

53063 - 53081

STOP TAIL AND NUMBER PLATE LAMPS

Part No.	†53063B	†53066D	†53067B	†53068B	†53071B	†A53071B	†53072B	†53076E	†53077A	†53079B	†53081A
Model	ST38C	ST38C	ST38C	ST38C	ST38D	ST38D	ST51-1	DC43	ST52D	ST51-1	ST51
Finish	Black	Black	Black	Primer	Black	Black	Black	Black	Black	Chromium	Black
Replaced by (see footnote)	(53440)	(53440)	(53578)	(53578)	(53440)	(53439)	(53390)	(53459)	(53244)	(53392)	(53390)
§Rim or door	520445	520445	520445	520445	520445	520445	—	‡521703	—	—	—
§Screw or nut, fixing	520403	520403	520403	520403	520403	520403	—	132564	—	—	—
Washer, screw retaining	161385	161385	161385	161385	161385	161385	161385	524215	161385	161385	161385
§Gasket	525555	525555	525555	525555	525555	525555	524760	516399	—	524760	524760
§Lens, stop tail	576415	576415	576415	576415	576415	576415	522264	524910	523255	522264	522264
§Lens or window, number plate	—	—	—	—	—	—	524843	—	—	524843	524843
§Partition or mounting platform	523584	523584	525579	525579	523584	523584	524808	520838	—	524088	—
Nut, partition body, contact or platform fixing	166019	166019	111784	111784	166019	166019	—	—	—	—	—
Washer, shakeproof	188330	188330	188353	188353	188330	188330	—	—	—	—	—
§Sleeve, terminal	188818	188818	188818	188818	188818	188818	188818	—	188818	188818	188818
Terminal, earth or screw	523571	523571	523571	523571	523571	523571	—	—	—	—	—
§Bulb	207	207	207	207	207	200	382	209	207	207	207
Nut, lamp fixing or coupling	166019	166019	166019	166019	166019	166019	166019	571388	166019	166019	166019
Washer, spring or shakeproof	188330	188330	188330	188330	188330	188330	185040	805040	188330	185040	185040
Washer, langite or leatheroid	—	—	—	—	—	—	—	—	523258	—	—
Body	—	—	—	—	—	—	524775	—	523648	524776	524775
Screw, body fixing	—	—	—	—	—	—	524552	—	133531	524552	524552
§Gasket, rubber	—	—	—	—	—	—	—	—	—	—	—
Fixing parts, set	—	—	—	—	—	—	524778	—	—	524778	524778
§Springs, lens fixing	—	—	—	—	—	—	—	524911	524662	—	—
Washer, body seating	—	—	—	—	—	—	522270	¶576167	—	522270	522270
§Grommet, rubber	—	—	—	—	—	—	—	—	—	—	—
Shell cable cover	—	—	—	—	—	—	—	571387	—	—	—
§Interior or contact	—	—	—	—	—	—	—	525762	—	—	—
§Bulb holder	—	—	—	—	—	—	—	—	—	—	—
Washer, tail lens	—	—	—	—	—	—	524839	—	—	524839	524839
Clamp, window fixing	—	—	—	—	—	—	—	—	—	—	—
Screw, clamp or contact assembly fixing	—	—	—	—	—	—	—	—	—	—	—
Plate, retaining or friction	—	—	—	—	—	—	—	—	—	—	—
Backplate or bracket, spring clips	—	—	—	—	—	—	—	—	—	—	—
Bolt, backplate or bracket fixing	—	—	—	—	—	—	—	—	—	—	—
Body, adaptor	—	—	—	—	—	—	—	524916	—	—	—
Nut, adaptor fixing	—	—	—	—	—	—	—	180064	—	—	—
Carrier, bulb	—	—	—	—	—	—	—	—	—	—	—
Nut, bulb carrier fixing or screw	—	—	—	—	—	—	—	—	—	—	—

Note. For replacement lamp spare parts, see appropriate column under part number * † When ordering, quote part number shown in brackets ‡ With lens § Recommended spares for stock
 || Washer, cover shell ¶ Washer, adaptor shell locking

DETAILED SPARE PARTS

STOP TAIL AND NUMBER PLATE LAMPS

Part No.	†53117A	†53118A	†53182B	53244B/D	†53269A/B	53295D	53304A	53304B/D	53389E	53390D	53390E
Model	476	476	477-1	525	525	533	533	533	ST51	ST51	ST51
Finish	Chromium	Chromium	C.P.R.	—	—	Black, C.P.R.	Black, C.P.R.	Black, C.P.R.	Black	Black	Black
Replaced by (see footnote)	—	(53117)	(53394)	—	(53394)	—	—	—	—	—	—
§Rim or door	—	—	‡526310	—	—	‡574120	‡574120	‡574120	—	—	—
§Screw or nut, fixing	—	—	—	572072	572072	127301	127301	127301	—	—	—
Washer, screw retaining	—	—	—	161385	161385	161385	161385	161385	161020	161020	161020
§Gasket	572431	572431	—	573814	573814	574111	574111	574111	526376	526376	526376
§Lens, stop tail	—	—	—	573819	573819	574108	574108	574108	524823	524823	524823
§Lens or window, number plate	572442	572442	—	—	—	574105	574105	574105	524843	524843	524843
§Partition or mounting platform	—	—	—	—	—	—	—	—	—	—	—
Nut, partition body, contact or platform fixing	—	—	—	—	—	—	166094	—	187108	187108	187108
Washer, shakeproof	—	—	—	—	—	188470	188412	—	188330	188330	188330
§Sleeve, terminal	—	—	—	—	—	—	188818	—	—	—	—
Terminal, earth or screw	—	—	—	—	—	121610	—	121610	—	—	—
§Bulb	382 ¶989	382 ¶989	352	380	352	5 ¶209	209	209	384	380	380
Nut, lamp fixing or coupling	166019	166019	—	166019	166019	177074	177074	177074	166019	166019	166019
Washer, spring or shakeproof	185040	185040	—	188330	188330	185040	—	185040	—	—	—
Washer, langite or leatheroid	—	—	—	161727	161727	—	—	—	—	—	—
Body	—	—	526322	—	—	574342	574104	574342	524832	524832	524832
Screw, body fixing	572430	572430	—	—	—	—	—	—	186181	198882	186181
§Gasket, rubber	—	—	—	—	—	574106	574106	574106	—	—	—
Fixing parts, set	—	—	—	—	—	—	—	—	—	—	—
§Springs, lens fixing	—	—	—	—	—	—	—	—	—	—	—
Washer, body seating	—	—	—	—	—	—	188470	188470	522270	522270	522270
§Grommet, rubber	—	—	526323	—	573825	574362	573232	574362	—	—	—
Shell, cable cover	—	—	—	—	—	—	—	—	—	—	—
§Interior or contact	—	—	552101	573828	573828	—	—	—	—	—	—
§Bulb holder	—	—	—	—	—	—	—	—	—	—	—
Washer, tail lens	—	—	—	—	—	—	—	—	—	—	—
Clamp, window fixing	—	—	—	—	—	—	—	—	—	—	—
Screw, clamp or contact assembly fixing	—	—	—	—	—	—	133766	—	—	—	—
Plate, retaining or friction	—	—	—	—	—	—	—	—	—	—	—
Backplate or bracket, spring clips	—	—	—	—	—	—	—	—	524849	524849	524849
Bolt, backplate or bracket fixing	—	—	—	—	—	—	—	—	—	—	—
Body, adaptor	—	—	—	—	—	—	—	—	—	—	—
Nut, adaptor fixing	—	—	—	—	—	—	—	—	—	—	—
Carrier, bulb	—	—	—	—	—	574122	574122	574122	—	—	—
Nut, bulb carrier fixing or screw	—	—	—	—	—	166043	166290	166043	—	—	—

Note. For replacement lamp spare parts, see appropriate column under part number † When ordering, quote part number shown in brackets ‡ With lens § Recommended spares for stock
 || Lens fixing ¶ Number plate C.P.R. . . Chromium plated rim

DETAILED SPARE PARTS

K26

53392 — 53443

STOP TAIL AND NUMBER PLATE LAMPS

Part No.	53392A	53392D	53392E	†53393F	53395B	†53398A/B	53426A/B	53439A	53440A	53443A
Model	ST51	ST51	ST51	518-2	469	525	525	ST38E	ST38E	ST38E
Finish	Chromium	Chromium	Chromium	Black	Chromium	—	—	Black	Black	Black
Replaced by (see footnote)	—	—	—	(53574)	—	(53244)	—	—	—	—
§Rim or door	—	—	—	—	‡573901	—	—	520445	520445	520445
§Screw or nut, fixing	—	—	—	—	113531	572072	572072	520403	520403	520403
Washer, screw retaining	161020	161020	161020	—	161385	161385	161385	—	—	—
§Gasket	524839	526376	526376	526441	572326	573841	573814	576420	576420	576420
§Lens, stop tail	524823	524823	524823	—	573900	573819	573819	576415	576415	576415
§Lens or window, number plate	524843	524843	524843	526437	—	—	—	576417	576417	576417
§Partition or mounting platform	—	—	—	—	—	—	—	576459	576459	576432
Nut, partition body, contact or platform fixing	—	187108	187108	—	—	—	—	132464	132464	132464
Washer, shakeproof	188330	188330	183330	188304	188470	—	—	188412	188412	188412
§Sleeve, terminal	—	—	—	188818	188818	188818	188818	188818	188818	188818
Terminal, earth or screw	—	—	—	—	—	—	—	—	—	—
Bulb	361	380	380	380	382 ¶1989	380	380	317 ¶ 205	382 ¶ 207	335 ¶ 209
Nut, lamp fixing or coupling	166019	166019	166019	—	177014	166019	166019	—	—	—
Washer, spring or shakeproof	—	—	—	—	—	188330	—	—	—	—
Washer, langite or leatheroid	—	—	—	—	—	161727	171627	—	—	—
Body	524835	524835	524835	526536	—	—	—	—	—	—
Screw, body fixing	524552	198882	186181	—	—	—	—	—	—	—
§Gasket, rubber	524760	—	—	526530	§572685	—	—	525555	525555	525555
Fixing parts, set	—	—	—	—	—	—	—	—	—	—
§Springs, lens fixing	—	—	—	—	—	—	—	—	—	—
Washer, body seating	5222270	522270	522270	—	—	—	—	—	—	—
§Grommet, rubber	—	—	—	—	199001	—	—	573232	573232	573232
Shell, cable cover	—	—	—	—	—	—	—	—	—	—
§Interior or contact	—	—	—	573828	—	573828	573828	—	—	—
§Bulb holder	—	—	—	—	—	—	—	—	—	—
Washer, tail lens	—	—	—	—	—	—	—	—	—	—
Clamp, window fixing	—	—	—	526442	—	—	—	**576423	**576423	**576423
Screw, clamp or contact assembly fixing	—	—	—	186130	—	—	—	††576424	††576424	††576424
Plate, retaining	—	—	—	526457	—	—	—	—	—	—
Plate, friction	—	—	—	526458	—	—	—	—	—	—
Backplate or bracket, spring clips	—	524849	524849	526371	—	—	—	575606	575606	575606
Bolt, backplate or bracket fixing	—	—	—	142784	—	—	—	198919	198919	198919
Body, adaptor	—	—	—	—	—	—	—	—	—	—
Nut, adaptor fixing	—	—	—	—	—	—	—	—	—	—
Carrier, bulb	—	—	—	—	—	—	—	—	—	—
Nut, bulb carrier fixing or screw	—	—	—	—	—	—	—	—	—	—

Note. For replacement lamp spare parts, see appropriate column under part number † When ordering, quote part number shown in brackets ‡ With lens § Recommended spares for stock
 || Lens fixing ¶ Number plate § Rubber bung ** Clip, top †† Clip, bottom

For illustrations, see page K22

continued

DETAILED SPARE PARTS

Part No.	53459A	†53534A/B	53534D	53574A/B	53578A	53629A	†523595	†524752	†524753	†525123
Model	DC43	533	533	518-2	ST38E	ST38E	ST38C	ST51	ST51	ST50C
Finish	Black	Black	Black	Black	Black	Black	Black	Black	Black	Chromium
Replaced by (see footnote)	—	(53295)	(53295)	—	—	—	(53340)	(53390)	(53390)	(53392)
§Rim or door	571958	‡574120	‡574120	—	520445	520445	520445	—	—	—
§Screw or nut, fixing	132564	126544	127301	—	520403	520403	520403	—	—	—
Washer, screw retaining	524215	161385	161385	—	—	—	161385	—	—	—
§Gasket	571956	574111	574111	526441	576420	576420	—	—	—	—
§Lens, stop tail	576415	574108	574108	—	576415	576415	576415	522264	522264	522264
§Lens or window, number plate	—	574105	574105	526437	576417	576417	—	524843	524843	523764
§Partition or mounting platform	520838	—	—	—	576459	576510	523584	—	—	—
Nut, partition body, contact or platform fixing	—	—	—	—	132464	132464	—	—	—	—
Washer, shakeproof	—	188470	188470	188304	188412	188412	—	—	—	—
§ Sleeve, terminal	—	188818	—	188818	188818	188818	188818	188818	188818	188818
Terminal, earth or screw	—	121610	121610	—	—	—	—	—	—	—
Bulb	209	335 †209	335 †209	380	207	—	207	205	207	207
Nut, lamp fixing or coupling	571388	177074	177074	—	—	—	166019	166019	166019	166019
Washer, spring or shakeproof	†805040	185040	185040	—	—	—	188330	185040	185040	188330
Washer, langite or leatheroid	—	—	—	—	—	—	—	524839	524760	524839
Body	—	574104	574342	526601	—	—	—	524775	524775	—
Screw, body fixing	—	—	—	—	—	—	—	132564	132564	524552
§Gasket, rubber	—	574106	574106	526530	525555	525555	525555	—	—	—
Fixing parts, set	—	—	—	—	—	—	—	524778	524778	—
§Springs, lens fixing	524911	—	—	—	—	—	—	—	—	523810
Washer, body seating	§576167	—	—	—	—	—	—	522270	522270	522270
§Grommet, rubber	—	573232	574362	—	—	573232	—	—	—	—
Shell cable cover	571387	—	—	—	—	—	—	—	—	—
§Interior or contact	525762	—	—	573828	—	—	—	—	—	—
§Bulb holder	—	—	—	—	—	—	—	—	—	—
Washer, tail lens	—	—	—	—	—	—	—	—	—	—
Clamp, window fixing	—	—	—	526442	**576423	**576423	—	—	—	—
Screw, clamp or contact assembly fixing	—	—	—	186130	††576424	††576424	—	—	—	—
Plate, retaining	—	—	—	526457	—	—	—	—	—	—
Plate, friction	—	—	—	526458	—	—	—	—	—	—
Backplate or bracket, spring clips	—	—	—	526371	575606	575606	—	—	—	—
Bolt, backplate or bracket fixing	—	—	—	142784	198919	198919	—	—	—	—
Body, adaptor	524916	—	—	—	—	—	—	—	—	—
Nut, adaptor fixing	180424	—	—	—	—	—	—	—	—	—
Carrier, bulb	—	574122	574122	—	—	—	—	—	—	—
Nut, bulb carrier fixing or screw	—	166043	166043	—	—	—	—	—	—	—

STOP TAIL AND NUMBER PLATE LAMPS

53459 — 525123

Note. For replacement lamp spare parts, see appropriate column under part number
 † When ordering, quote part number shown in brackets ‡ With lens § Recommended spares for stock
 †† Number plate ‡‡ Washer, cover shell § Washer, locking, adaptor nut ** Clip, top ††† Clip, bottom



STOP TAIL LAMPS



For detailed spare parts, see pages K30-K36

STOP TAIL LAMPS

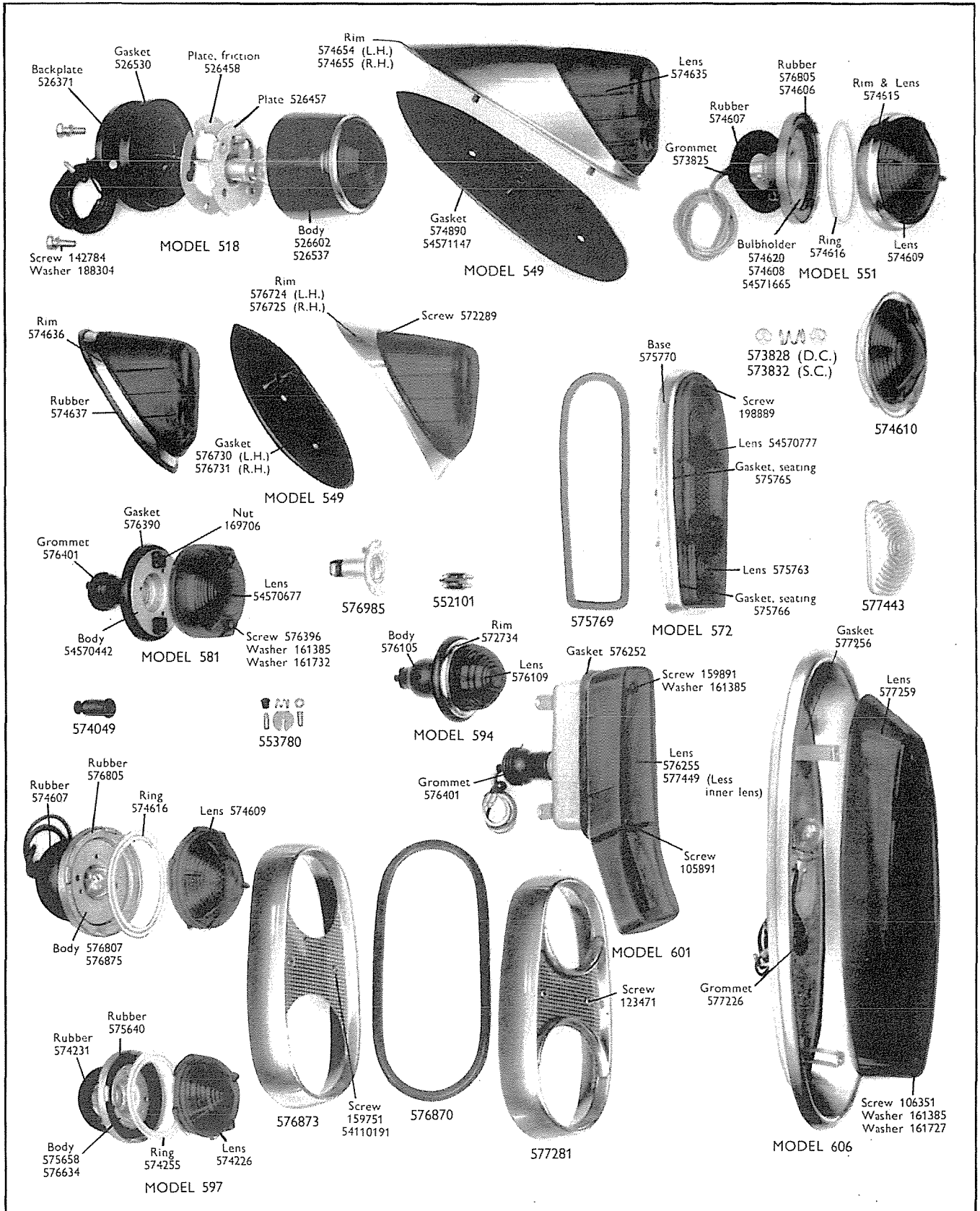

For detailed spare parts, see pages K30-K36

DETAILED SPARE PARTS

K30

53049 — 53150

STOP TAIL LAMPS

Part No.	53049A	†53057A	†53082B	†53091E	53099A	†53102D	†53120B	†53127B	53131B	†53134B	†53150B
Model	ST53	ST54	461	461	472	471	464	464	482	484	461-1
Finish	C.P.R.	C.P.R.	C.P.R.	C.P.R.	—	C.P.R.	C.P.R.	C.P.R.	C.P.R.	C.P.R.	C.P.R.
Replaced by (see footnote)	—	(53594)	(53194)	(53193)	—	(53200)	(53173)	(53207)	—	(53172)	(53194)
§Rim or door	—	525365	‡572792	‡571749	—	572224	573153	573153	—	572580	‡572792
§Screw or nut, fixing	—	—	113531	116141	113531	572072	572072	572072	572510	572582	113531
Washer, screw retaining	161385	—	—	—	161385	161385	161385	161385	—	161385	—
§Gasket, rubber, lens seating	525188	523324	—	—	572160	572225	571979	571979	—	—	—
§Gasket, rubber, lower lens seating	—	—	—	—	—	—	—	—	—	—	—
§Lens, stop or stop tail	525186	523307	—	—	572403	572239	571997	572089	572507	572578	—
§Lens, tail, lower or inner	—	—	—	—	—	—	—	—	—	—	—
Bracket and spring, inner lens retaining	—	—	—	—	—	—	—	—	—	—	—
§Ring, sliding (stop tail)	—	—	—	—	—	—	—	—	—	—	—
§Ring, sliding (tail)	—	—	—	—	—	—	—	—	—	—	—
Screw, bracket fixing	—	—	—	—	—	126463	—	—	—	126463	—
Washer, shakeproof	188330	—	—	—	—	131023	—	—	—	131023	—
Pad, seating, offside	—	—	—	—	—	—	—	—	—	572584	—
Pad, seating, nearside	—	—	—	—	—	—	—	—	—	575585	—
§Sleeve, terminal	188818	188818	188818	188818	—	—	188818	188818	—	—	188818
Cover, bulb or dust	—	—	—	—	—	—	—	—	—	—	—
§Bulb holder	—	—	¶571739	¶571739	—	—	—	—	—	572583	¶571739
§Interior (tail)	—	—	—	—	—	—	—	—	—	—	—
§Interior (stop tail)	—	—	552101	552101	552101	552101	552101	552103	—	552101	552101
§Bulb	207	207	381	381	381	381	381	382	381	381	381
Backshell or backplate	—	—	—	—	572406	—	—	—	—	—	—
Screw, plate, body or bulb holder fixing	§100003	—	—	—	—	—	—	—	—	—	—
Washer, spring	—	—	—	—	—	—	—	—	—	—	—
Washer, rubber or fibre	525194	—	523986	523986	—	—	—	—	199001	—	571758
Plate, bulb holder or retaining	—	—	—	—	—	—	—	—	—	—	—
Plate, friction	—	—	—	—	—	—	—	—	—	—	—
Ring, adaptor	—	—	571738	571738	—	—	—	—	—	—	571738
Body or base	—	—	—	—	—	—	—	—	—	—	—
Nut, lamp fixing	—	—	—	—	—	—	—	—	—	—	—
Screw, body or base fixing	—	—	—	—	—	—	—	—	—	—	—
§Gasket, body seating (stop tail)	525195	—	—	—	—	—	—	—	—	—	—
§Gasket, body seating (tail)	—	—	—	—	—	—	—	—	—	—	—
§Grommet, rubber (stop tail)	—	—	—	—	—	—	526302	526302	—	—	—
§Grommet, rubber (tail)	—	—	—	—	—	—	—	—	—	—	—

Note. For replacement lamp spare parts, see appropriate column under part number † When ordering, quote part number shown in brackets ‡ Lens and rim § Recommended spares for stock
 || Lens fixing ¶ Shell only § Also screw, strap fixing C.P.R. . . Chromium plated rim

For illustrations, see pages K28-K29

continued

DETAILED SPARE PARTS

Part No.	†53151A/J	†53156D	†53166B	53172B	53173B	53174B/E	¶53178A/J	†¶A53178 A/J	53180E	†53192B	53193B
Model	488	464	464	484	464	464	488	488	464	461	461
Finish	C.P.R.	C.P.R.	C.P.R.	C.P.R.	C.P.R.	C.P.R.	C.P.R.	C.P.R.	C.P.R.	C.P.R.	C.P.R.
Replaced by (see footnote)	(53178)	(53226)	(53226)	—	—	—	—	(53906)	—	(53193)	—
§Rim or door	572734	573153	573153	572580	573153	573153	572734	572734	573153	‡571749	‡571749
§Screw or nut, fixing	—	572072	572072	572582	572072	572072	—	—	572072	116141	116141
Washer, screw retaining	—	161385	161385	161385	161385	161385	—	—	161385	—	—
§Gasket, rubber, lens seating	—	571979	572087	—	571979	571979	—	—	572065	—	—
§Gasket, rubber, lower lens seating	—	—	—	—	—	—	—	—	—	—	—
§Lens, stop or stop tail	54570664	572888	572888	572578	571997	572673	54570664	54570664	572673	—	—
§Lens, tail, lower or inner	—	—	—	—	—	—	—	—	—	—	—
Bracket and spring, inner lens retaining	—	—	—	—	—	—	—	—	—	—	—
§Ring, sliding (stop tail)	—	—	—	—	—	—	—	—	—	—	—
§Ring, sliding (tail)	—	—	—	—	—	—	—	—	—	—	—
Screw, bracket fixing	—	—	—	126463	—	—	—	—	—	—	—
Washer, shakeproof	—	—	—	131023	—	—	—	—	—	—	—
Pad, seating, offside	—	—	—	572584	—	—	—	—	—	—	—
Pad, seating, nearside	—	—	—	572585	—	—	—	—	—	—	—
§Sleeve, terminal	555910	188818	188818	—	188818	555910	555910	188818	555910	188818	188818
Cover, bulb or dust	—	—	—	—	—	—	—	—	—	—	—
§Bulb holder	573251	—	—	572587	—	—	572727	572727	—	572804	572804
§Interior (tail)	—	—	—	—	—	—	—	—	—	—	—
§Interior (stop tail)	552101	552101	552101	552101	552101	552101	552101	552101	552101	552101	552101
§Bulb	381	381	380	380	380	361	380	384	380	380	380
Backshell or backplate	—	—	—	—	—	—	—	—	—	—	—
Screw, plate, body or bulb holder fixing	—	—	—	—	—	—	—	—	—	—	—
Washer, spring	—	—	—	—	—	—	—	—	—	—	—
Washer, rubber or fibre	—	—	—	—	—	—	—	—	—	523986	571758
Plate, bulb holder or retaining	—	—	—	—	—	—	—	—	—	—	—
Plate, friction	—	—	—	—	—	—	—	—	—	—	—
Ring, adaptor	—	—	—	—	—	—	—	—	—	571738	571738
Body or base	575003	—	—	—	—	—	575003	575003	—	—	—
Nut, lamp fixing	—	—	—	—	—	—	—	—	—	—	—
Screw, body or base fixing	—	—	—	—	—	—	—	—	—	—	—
§Gasket, body seating (stop tail)	—	—	—	—	—	—	—	—	—	—	—
§Gasket, body seating (tail)	—	—	—	—	—	—	—	—	—	—	—
§Grommet, rubber (stop tail)	—	526302	526302	—	526302	576401	—	—	—	—	—
§Grommet, rubber (tail)	—	—	—	—	—	—	—	—	—	—	—

STOP TAIL LAMPS

Note. For replacement lamp spare parts, see appropriate column under part number † When ordering, quote part number shown in brackets ‡ Lens and rim § Recommended spares for stock
 || Shell only ¶ Also flasher C.P.R. . . . Chromium plated rim

DETAILED SPARE PARTS

53194 — 53305

STOP TAIL LAMPS

Part No.	53194B	†53196B	†53197A	53200A	†53204B	53211H/J	53218B	†53220A	53226D	53288A	§53305B/E
Model	461	464	471	471	461	488	515	471	464E	471	542
Finish	C.P.R.	C.P.R.	C.P.R.	C.P.R.	C.P.R.	C.P.R.	—	C.P.R.	C.P.R.	C.P.R.	C.P.R.
Replaced by (see footnote)	—	(53173)	(53200)	—	(53194)	—	—	(53200)	—	—	—
§Rim or door	‡572792	573153	572224	572224	‡572792	572734	—	572224	573164	572224	‡574325
§Screw or nut, fixing	113531	572072	—	572072	113531	—	—	572072	573676	—	—
Washer, screw retaining	—	161385	—	161385	—	—	—	161385	161385	—	—
§Gasket, rubber, lens seating	—	571979	—	572225	—	—	573545	—	572087	—	574328
§Gasket, rubber, lower lens seating	—	—	—	—	—	—	—	—	—	—	—
§Lens, stop or stop tail	—	571997	572239	572239	—	54570664	573543	572239	572888	572239	574323
§Lens, tail, lower or inner	—	—	—	—	—	—	—	—	—	—	—
Bracket and spring, inner lens retaining	—	—	—	—	—	—	573555	—	—	—	—
§Ring, sliding (stop tail)	—	—	—	—	—	—	—	—	—	—	—
§Ring, sliding (tail)	—	—	—	—	—	—	—	—	—	—	—
Screw, bracket fixing	—	—	126463	126463	—	—	—	126463	—	126463	—
Washer, shakeproof	—	—	131023	131023	—	—	—	131023	—	131023	—
Pad, seating, offside	—	—	—	—	—	—	—	—	—	—	—
Pad, seating, nearside	—	—	—	—	—	—	—	—	—	—	—
§Sleeve, terminal	188818	188818	—	—	188818	555910	—	—	555910	—	555910
Cover, bulb or dust	—	—	—	—	—	—	—	—	—	—	—
§Bulb holder	572804	—	—	—	572804	572727	573557	—	—	—	—
§Interior (tail)	—	—	—	—	—	—	—	—	—	—	—
§Interior (stop tail)	552101	552101	552101	552101	552101	552101	—	552101	552101	552101	552101
§Bulb	380	380	380	380	380	380	380	380	380	380	380
Backshell or backplate	—	—	—	—	—	—	—	—	—	—	574329
Screw, plate, body or bulb holder fixing	—	—	—	—	—	—	—	—	—	—	198868
Washer, spring	—	—	—	—	—	—	—	—	—	—	188330
Washer, rubber or fibre	571758	—	—	—	523986	¶572733	—	—	—	—	—
Plate, bulb holder or retaining	—	—	—	—	—	—	—	—	—	—	—
Plate, friction	—	—	—	—	—	—	—	—	—	—	—
Ring, adaptor	571738	—	—	—	571738	—	—	—	—	—	—
Body or base	—	—	—	—	—	—	573544	—	—	—	—
Nut, backplate fixing	—	—	—	—	—	—	—	—	—	—	166019
Screw, body or base fixing	—	—	—	—	—	—	—	—	—	—	—
§Gasket, body seating (stop tail)	—	—	—	—	—	—	—	—	—	—	—
§Gasket, body seating (tail)	—	—	—	—	—	—	—	—	—	—	—
§Grommet, rubber (stop tail)	—	—	—	—	—	—	—	—	526302	—	—
§Grommet, rubber (tail)	—	—	—	—	—	—	—	—	—	—	—

Note. For replacement lamp spare parts, see appropriate column under part number † When ordering, quote part number shown in brackets ‡ Lens and rim § Recommended spares for stock
 || Shell only ¶ Ring, rubber, mounting § For illustration, see page K38 C.P.R. . . Chromium plated rim

For illustrations, see pages K28–K29

continued

K32

DETAILED SPARE PARTS

Part No.	53310D	53311D	53318A	53330D	53332B	53332D	†53350F/H	†53351F/H	†53372A	53377B
Model	546	546	471	549	551	551	549	549	538	551
Finish	C.P.R.	C.P.R.	C.P.R.	C.P.R.	C.P.R.	C.P.R.	C.P.R.	C.P.R.	C.P.R.	C.P.R.
Replaced by (see footnote)	—	—	—	—	—	—	(53838)	(53839)	(53624)	—
§Rim or door	574450	574450	572249	574636	‡574610	‡574610	574654	574655	‡574259	‡574615
§Screw or nut, fixing	—	—	572072	572289	—	—	572289	572289	—	—
Washer, screw retaining	—	—	161385	—	—	—	—	—	—	—
§Gasket, rubber, lens seating	574451	574451	572245	574634	574606	576805	574634	574634	575640	576805
§Gasket, rubber, lower lens seating	—	—	—	—	—	—	—	—	—	—
§Lens, stop or stop tail	574461	574460	572239	574635	574609	574609	574635	574635	574226	574609
§Lens, tail, lower or inner	—	—	—	—	—	—	—	—	—	—
Bracket and spring, inner lens retaining	—	—	—	—	—	—	—	—	—	—
§Ring, sliding (stop tail)	—	—	—	—	574616	574616	—	—	574255	574616
§Ring, sliding (tail)	—	—	—	—	—	—	—	—	—	—
Screw, bracket fixing	—	—	126463	—	—	—	—	—	—	—
Washer, shakeproof	188330	188330	131023	—	—	—	—	—	—	—
Pad, seating, offside	—	—	—	—	—	—	—	—	—	—
Pad, seating, nearside	—	—	—	—	—	—	—	—	—	—
§Sleeve, terminal	555910	555910	—	555910	—	555910	555910	555910	—	555910
Cover, bulb or dust	574445	574445	—	—	—	—	—	—	—	—
§Bulb holder	574456	574457	—	—	—	—	—	—	—	—
§Interior (tail)	—	—	—	—	—	—	—	—	—	—
§Interior (stop tail)	552101	552101	552101	—	573828	573828	—	—	573828	573828
§Bulb	380	380	380	380	380	380	380	380	380	380
Backshell or backplate	—	—	—	—	574608	574608	—	—	—	—
Screw, plate, body or bulb holder fixing	—	—	—	—	—	—	—	—	—	—
Washer, spring	—	—	—	—	—	—	—	—	—	—
Washer, rubber or fibre	—	—	—	—	—	—	—	—	—	—
Plate, bulb holder or retaining	—	—	—	—	—	—	—	—	—	—
Plate, friction	—	—	—	—	—	—	—	—	—	—
Ring, adaptor	—	—	—	—	—	—	—	—	—	—
Body or base	—	—	—	—	—	—	—	—	574224	574620
Nut, lamp fixing	166019	166019	—	—	—	—	—	—	—	—
Screw, body or base fixing	—	—	—	126544	—	—	—	—	—	—
§Gasket, body seating (stop tail)	—	—	—	574637	574607	574607	574890	574890	574231	574607
§Gasket, body seating (tail)	—	—	—	—	—	—	—	—	—	—
§Grommet, rubber (stop tail)	—	—	—	—	—	573825	—	—	—	—
§Grommet, rubber (tail)	—	—	—	—	—	—	—	—	—	—

STOP TAIL LAMPS

53310 — 53377

Note. For replacement lamp spare parts, see appropriate column under part number † When ordering, quote part number shown in brackets ‡ Lens and rim § Recommended spares for stock
 || Lens fixing C.P.R. . . Chromium plated rim

K33

For illustrations, see pages K28-K29

continued

DETAILED SPARE PARTS

K34

53384 — 53589

STOP TAIL LAMPS

Part No.	53384B	53405E	53444A/E	53460B	53520B/D	53564A/D	53566A	53576A	53577A	53589A/B
Model	551	518-2	572	538RR	581	594	551	549	549	597
Finish	C.P.R.	Black	C.P.R.	C.P.R.	—	C.P.R.	C.P.R.	C.P.R.	C.P.R.	C.P.R.
Replaced by (see footnote)	—	—	—	—	—	—	—	—	—	—
§Rim or door	‡574615	—	—	‡574259	—	572734	‡574615	—	—	576873
§Screw or nut, fixing	—	—	198889	—	576396	—	—	572289	572289	159751
Washer, screw retaining	—	—	—	—	161385	—	—	—	—	161385
§Gasket, rubber, lens seating	576805	—	575765	575640	—	—	576805	574634	574634	575640
§Gasket, rubber, lower lens seating	—	—	575766	—	—	—	—	—	—	576805
§Lens, stop or stop tail	574609	—	54570777	574226	54570677	576109	574609	574635	574635	574609
§Lens, tail, lower or inner	—	—	575763	—	—	—	—	—	—	574226
Bracket and spring, inner lens retaining	—	—	—	—	—	—	—	—	—	—
§Ring, sliding (stop tail)	574616	—	—	574255	—	—	574616	—	—	574616
§Ring, sliding (tail)	—	—	—	—	—	—	—	—	—	574255
Screw, bracket fixing	—	—	—	—	—	—	—	—	—	—
Washer, shakeproof	—	188304	188330	—	—	—	—	—	—	—
Pad, seating, offside	—	—	—	—	—	—	—	—	—	¶1576870
Pad, seating, nearside	—	—	—	—	—	—	—	—	—	—
§Sleeve, terminal	555910	188818	555910	—	555910	555910	555910	555910	555910	188818
Cover, bulb or dust	—	—	—	—	—	—	—	—	—	—
§Bulb holder	—	—	—	—	—	576985	—	—	—	576634
§Interior (tail)	—	—	—	—	—	—	—	—	—	553780
§Interior (stop tail)	573828	573828	552101	573828	552101	552101	573828	—	—	573832
§Bulb	380	380	380	380	380	380	380	380	380	382 §989
Backshell or backplate	—	526371	—	—	—	—	—	—	—	—
Screw, plate, body or bulb holder fixing	—	142784	—	—	—	—	—	—	—	186137
Washer, spring	—	—	—	—	—	—	—	—	—	—
Washer, rubber or fibre	—	—	—	—	161732	—	—	—	—	—
Plate, bulb holder or retaining	—	526457	—	—	—	—	—	—	—	—
Plate, friction	—	526458	—	—	—	—	—	—	—	—
Ring, adaptor	—	—	—	—	—	—	—	—	—	—
Body or base	574608	**526537	575770	—	576391	576105	574608	576725	576724	576875
Nut, lamp fixing	—	—	166019	—	††169706	—	—	—	—	—
Screw, body or base fixing	—	—	—	—	—	—	—	—	—	126643
§Gasket, body seating (stop tail)	574607	526530	575769	574231	576390	—	574607	576731	576730	574607
§Gasket, body seating (tail)	—	—	—	—	—	—	—	—	—	574231
§Grommet, rubber (stop tail)	—	—	—	—	—	—	—	—	—	—
§Grommet, rubber (tail)	—	—	—	—	—	—	—	—	—	—

Note. For replacement lamp spare parts, see appropriate column under part number ‡ Lens and rim § Recommended spares for stock ¶ Lens fixing ¶ Gasket, rim seating § Tail
 ** Incorporates lens †† Nut, lens fixing screw C.P.R. . . Chromium plated rim

For illustrations, see pages K28-K29

continued

DETAILED SPARE PARTS

Part No.	53589E/F	†53592A/J	†53592K	†53592M	53594A	53599E/F	53608A/B	53624A	†53642B/D	53670A
Model	597	597	597	597	ST54	601	518-2	538	606	597
Finish	C.P.R.	C.P.R.	C.P.R.	C.P.R.	C.P.R.	—	Black	C.P.R.	C.P.R.	C.P.R.
Replaced by (see footnote)	—	(53670)	(53670)	(53670)	—	—	—	—	(53702)	—
§Rim or door	576873	576873	577281	577281	525365	—	—	‡574259	—	577281
§Screw or nut, fixing	54110191	159751	123471	123471	—	105891	—	—	106351	123471
Washer, screw retaining	161385	161385	161385	161385	—	161385	—	—	161385	161385
§Gasket, rubber, lens seating	575640	575640	575640	575640	523324	576252	—	575640	577256	575640
§Gasket, rubber, lower lens seating	576805	576805	576805	576805	—	—	—	—	—	576805
§Lens, stop or stop tail	574609	574609	574609	574609	571717	576255	—	574226	577259	574609
§Lens, tail, lower or inner	574226	574226	574226	574226	—	—	—	—	—	574226
Bracket and spring, inner lens retaining	—	—	—	—	—	—	—	—	—	—
§Ring, sliding (stop tail)	574616	574616	574616	574616	—	—	—	574255	—	574616
§Ring, sliding (tail)	574255	574255	574255	574255	—	—	—	—	—	574255
Screw, bracket fixing	—	—	—	—	—	¶159891	—	—	—	—
Washer, shakeproof	—	—	—	—	—	—	188304	—	—	—
Pad, seating, offside	§576870	§576870	§576870	—	—	—	—	—	—	—
Pad, seating, nearside	—	—	—	—	—	—	—	—	—	—
§Sleeve, terminal	555910	188818	555910	555910	—	—	188818	—	555910	555910
Cover, bulb or dust	—	—	—	—	—	—	—	—	—	—
§Bulb holder	576634	576634	576634	576634	—	—	—	—	—	576634
§Interior (tail)	553780	553780	553780	553780	—	—	—	—	—	553780
§Interior (stop tail)	573832	573832	573832	573832	—	573828	573828	573828	573828	573832
§Bulb	382 **989	382 **989	382 **989	382 **989	382 **207	380	380	380	380	382 **989
Backshell or backplate	—	—	—	—	—	—	526371	—	—	—
Screw, plate, body or bulb holder fixing	186137	—	—	—	—	—	142784	—	—	—
Washer, spring	—	—	—	—	—	—	—	—	—	—
Washer, rubber or fibre	—	—	—	—	—	—	—	—	161727	—
Plate, bulb holder or retaining	—	—	—	—	—	—	526457	—	—	—
Plate, friction	—	—	—	—	—	—	526458	—	—	—
Ring, adaptor	—	—	—	—	—	—	—	—	—	—
Body or base	576875	576875	576875	576875	—	—	526602	574224	—	576875
Nut, lamp fixing	—	—	—	—	—	—	—	—	—	—
Screw, body or base fixing	—	—	—	—	—	—	—	—	—	—
§Gasket, body seating (stop tail)	574607	574607	—	574607	—	—	526530	574231	—	—
§Gasket, body seating (tail)	574231	574231	—	574231	—	—	—	—	—	—
§Grommet, rubber (stop tail)	573825	—	573825	573825	—	576401	—	576401	577266	573825
§Grommet, rubber (tail)	574049	—	574049	574049	—	—	—	—	—	574049

STOP TAIL LAMPS

53589 — 53670

Note. For replacement lamp spare parts, see appropriate column under part number † When ordering, quote part number shown in brackets ‡ Lens and rim § Recommended spares for stock
 || Lens fixing ¶ Lens fixing, long § Gasket, rim seating ** Tail C.P.R. . . Chromium plated rim

DETAILED SPARE PARTS

K36

53693 — 53906

Part No.	53693A/D	53702A/D	53783B/E	53818A/B	53819A	53838A	53839A	†53840A	53875A	53906A
Model	601	606	581	538	551	549	549	538	551	488
Finish	—	C.P.R.	—	—	C.P.R.	C.P.R.	C.P.R.	C.P.R.	C.P.R.	C.P.R.
Replaced by (see footnote)	—	—	—	—	—	—	—	(53624)	—	—
§Rim or door	—	—	—	—	‡574615	574654	574655	‡574259	‡574615	572734
§Screw or nut, fixing	105891	106351	576396	—	—	572289	572289	—	—	—
Washer, screw retaining	161385	161385	161385	—	—	—	—	—	—	—
§Gasket, rubber, lens seating	576252	577256	576390	575640	576805	574634	574634	575640	576805	—
§Gasket, rubber, lower lens seating	—	—	—	—	—	—	—	—	—	—
§Lens, stop or stop tail	577449	577259	54570677	574226	574609	574635	574635	574226	574609	54570664
§Lens, tail, lower or inner	577443	—	—	—	—	—	—	—	—	—
Bracket and spring, inner lens retaining	577446	—	—	—	—	—	—	—	—	—
§Ring, sliding (stop tail)	—	—	—	574255	574616	—	—	574255	574616	—
§Ring, sliding (tail)	—	—	—	—	—	—	—	—	—	—
Screw, bracket fixing	¶159891	—	—	—	—	—	—	—	—	—
Washer, shakeproof	—	—	—	—	—	—	—	—	—	—
Pad, seating, offside	—	—	—	—	—	—	—	—	—	—
Pad, seating, nearside	—	—	—	—	—	—	—	—	—	—
§Sleeve, terminal	—	555910	555910	—	555910	555910	555910	—	555910	555910
Cover, bulb or dust	—	—	—	—	—	—	—	—	—	—
§Bulb holder	—	—	—	—	—	—	—	—	—	572727
§Interior (tail)	—	—	—	—	—	—	—	—	—	—
§Interior (stop tail)	573828	573828	573828	573828	573828	—	—	573828	573828	552101
§Bulb	380	380	380	380	380	380	380	380	380	384
Backshell or backplate	—	—	—	—	574620	—	—	—	54571665	—
Screw, plate, body or bulb holder fixing	—	—	—	—	—	—	—	—	—	—
Washer, spring	—	—	—	—	—	—	—	—	—	—
Washer, rubber or fibre	—	161727	161732	—	—	—	—	—	—	—
Plate, bulb holder or retaining	—	—	—	—	—	—	—	—	—	—
Plate, friction	—	—	—	—	—	—	—	—	—	—
Ring, adaptor	—	—	—	—	—	—	—	—	—	—
Body or base	—	—	54570442	574224	—	—	—	576356	—	575003
Nut, lamp fixing	—	—	§169706	—	—	—	—	—	—	—
Screw, body or base fixing	—	—	—	—	—	—	—	—	—	—
§Gasket, body seating (stop tail)	—	—	—	574231	576407	54571147	54571147	574231	574607	—
§Gasket, body seating (tail)	—	—	—	—	—	—	—	—	—	—
§Grommet, rubber (stop tail)	576401	577266	576401	—	—	—	—	—	—	—
§Grommet, rubber (tail)	—	—	—	—	—	—	—	—	—	—

STOP TAIL LAMPS

Note. For replacement lamp spare parts, see appropriate column under part number † When ordering, quote part number shown in brackets ‡ Lens and rim § Recommended spares for stock
 || Lens fixing ¶ Lens fixing, long § Nut, lens fixing screw C.P.R. . . Chromium plated rim

For illustrations, see pages K28–K29

STOP TAIL AND FLASHER LAMPS

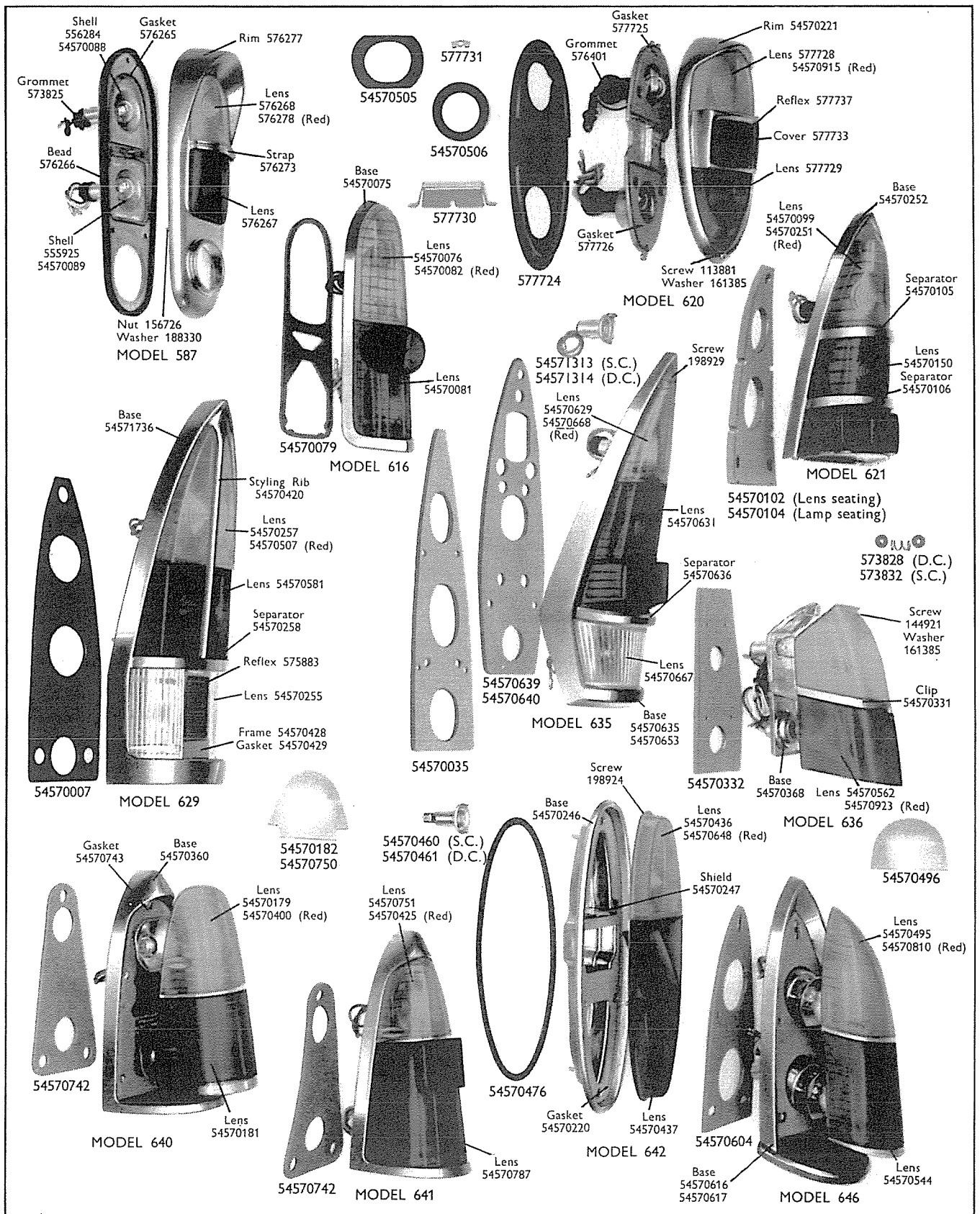

For detailed spare parts, see pages K40-K46

STOP TAIL AND FLASHER LAMPS

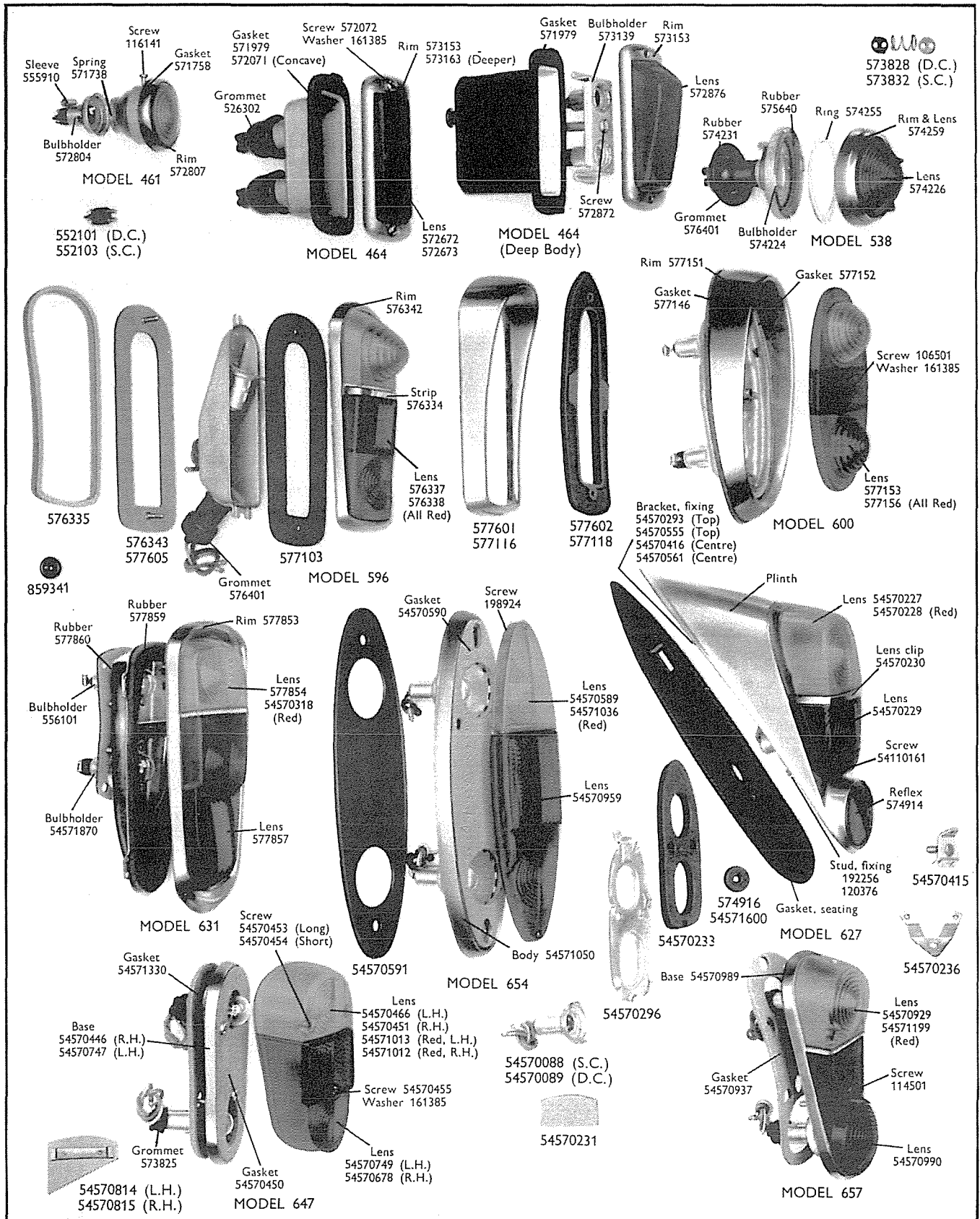

For detailed spare parts, see pages K40-K46



STOP TAIL AND FLASHER LAMPS

DETAILED SPARE PARTS

Part No.	†53145B	†53146D	53153E	53174B/E	†53176B	53178A/J	53183B	53199B	53227A
Model	464	464	464	464	464	488	464	464	464
Finish	C.P.R.	C.P.R.	C.P.R.	C.P.R.	C.P.R.	C.P.R.	C.P.R.	C.P.R.	C.P.R.
Replaced by (see footnote)	(53183)	(53183)	—	—	(53183)	—	—	—	—
(1) §Rim	573153	573153	573153	573153	573153	572734	573153	573153	573163
(2) Screw or nut, rim fixing	572072	572072	572072	572072	572072	—	572072	572072	572072
(3) Washer, retaining	161385	161385	161385	161385	161385	—	161385	161385	161385
(4) §Lens	572672	572672	572876	572673	572672	54570664	572672	572876	572672
(5) Screw, strap or lens fixing	—	—	—	—	—	—	—	—	—
(6) §Ring, sliding	—	—	—	—	—	—	—	—	—
(7) §Gasket, lens or rim seating	571979	571979	571979	571979	571979	—	571979	571979	572071
(8) Bracket, bulb holder	—	—	—	—	—	—	—	—	—
(9) §Bulb holder (stop tail)	—	—	—	—	—	572727	—	—	—
(10) §Bulb holder (flasher)	—	—	—	—	—	—	—	—	—
(11) §Interior (stop tail)	552101	552101	552101	552101	552101	552101	552101	552101	552101
(12) §Interior (flasher)	552103	552103	552103	—	552103	—	552103	—	552103
(13) §Bulb (stop tail)	381	381	381	361	380	380	380	380	380
(14) §Bulb (flasher)	382	382	382	—	382	—	382	—	382
(15) §Gasket, body seating	—	—	—	—	—	—	—	—	—
(16) §Sleeve, terminal	188818	188818	188818	555910	188818	555910	188818	188818	188818
(17) §Screw, stop tail bulb holder fixing	—	—	—	—	—	—	—	572872	—
(18) Base or body	—	—	—	—	—	575003	—	—	—
(19) Plate, bulb holder or backplate	—	—	573139	—	—	—	—	573152	—
(20) Screw, plate fixing, or nut	—	—	572872	—	—	—	—	—	—
(21) Nut or screw, lamp or base fixing	—	—	—	—	—	—	—	—	—
(22) Washer, locking	—	—	—	—	—	—	—	—	—
(23) §Grommet, cable entry	526302	—	—	576401	—	—	526302	—	526302

Part No.	†53351F/H	53356H/J	†53372A	**53377B	53381D/H	53382D/H	53407E/H	53410B	53444A/E
Model	549	558	538	551	549	549	570	571	572
Finish	C.P.R.	C.P.R.	C.P.R.	C.P.R.	C.P.R.	C.P.R.	C.P.R.	C.P.R.	C.P.R.
Replaced by (see footnote)	(53839)	—	(53624)	—	—	—	—	—	—
(1) §Rim	574655	574874	574259	574615	574667	574668	575365	575452	—
(2) Screw or nut, rim fixing	—	572072	—	—	—	—	186136	—	—
(3) Screw, rim fixing, long	—	—	—	—	—	—	—	—	—
(4) Washer, retaining	—	—	—	—	—	—	—	—	—
(5) §Lens	574635	575581	574226	574609	574635	574635	—	575449	—
(6) §Lens, stop tail or outer	—	—	—	—	—	—	54570762	—	54570777
(7) §Lens, flasher, inner or reverse	—	—	—	—	—	—	575364	—	575763
(8) Strap, lens or reflex retaining	—	—	—	—	—	—	—	—	—
(9) Screw, strap or lens fixing	572289	—	—	—	572289	572289	—	572072	198889
(10) §Ring, sliding	—	—	574255	574616	—	—	—	—	—
(11) §Gasket, lens or rim seating	574634	574884	575640	576805	574634	574634	575368	575451	575765
(12) Bracket, bulb holder	—	574886	—	—	—	—	575370	—	575766
(13) §Bulb holder (stop tail)	—	—	—	—	—	—	555384	—	—
(14) §Bulb holder (flasher or reverse)	—	—	—	—	—	—	556284	—	—
(15) §Interior (stop tail)	—	552101	573828	573828	—	—	552101	552101	552101
(16) §Interior (flasher or reverse)	—	552103	—	—	—	—	552103	—	—
(17) §Bulb (stop tail)	380	380	380	380	380	380	380	380	380
(18) §Bulb (flasher or reverse)	—	382	—	—	—	—	382	—	—
(19) §Gasket, body seating	574890	—	574231	—	574901	574901	575369	575450	575769
(20) §Sleeve, terminal	555910	555910	—	555910	555910	555910	555910	555910	555910
(21) Plate, steel, masking	—	574889	—	—	—	—	—	—	—
(22) §Seal, rubber, masking	—	575580	—	—	—	—	—	—	—
(23) Cover, rear	—	574885	—	—	—	—	—	—	—
(24) §Reflex reflector	—	—	—	—	—	—	—	—	—
(25) §Screw, stop tail bulb holder fixing	—	—	—	—	—	—	—	—	—
(26) Washer, shakeproof, fixing screw	—	—	—	—	—	—	—	—	—
(27) §Gasket, stop tail bulb holder seating	—	—	—	—	—	—	—	—	—
(28) Base or body	—	—	574224	574607	—	—	—	575446	575770
(29) Plate, bulb holder or backplate	—	—	—	574620	—	—	—	—	—
(30) Screw, plate fixing, or nut	—	—	—	—	—	—	—	—	—
(31) Washer, screw retaining	—	—	—	—	—	—	—	—	—
(32) Screw, lens mounting	—	—	—	—	—	—	—	—	—
(33) §Gasket, lens wall	—	—	—	—	—	—	—	—	—
(34) Screw, lamp or base fixing	—	—	—	—	147924	147924	—	—	—
(35) Nut, lamp or base fixing	—	—	—	—	—	—	—	—	166019
(36) Washer, locking	—	—	—	—	5505652	5505652	—	—	188330
(37) §Grommet, cable entry	—	—	—	—	—	—	—	572039	—
(38) Washer, cable grip	—	—	—	—	—	—	—	—	—

For illustrations, see pages K37-K39

Note. For replacement lamp spare parts, see appropriate column under part number
 † When ordering, quote part number shown in brackets ‡ With lens
 § Recommended spares for stock ¶ Outer lens seating * Lower lens seating § Ring, retaining ** For illustrations, see page K52
 C.P.R. . . . Chromium plated rim

STOP TAIL AND FLASHER LAMPS

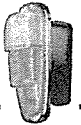

DETAILED SPARE PARTS

	53280B/L 523 Silver rim —	†53298A 538 C.P.R. (53624)	53306A 461-1 C.P.R. —	53312D 546 C.P.R. —	53313D 546 C.P.R. —	53330D 549 C.P.R. —	53339E/K 553 Chromium —	53340E/F 549 C.P.R. —	53340H 549 C.P.R. —	53341E/F 549 C.P.R. —	53341H 549 C.P.R. —	†53350F/H 549 C.P.R. (53838)
574072	—	‡574259	‡572807	574450	574450	574636	—	574644	574644	574645	574645	574654 (1)
—	—	—	116141	—	—	—	—	—	—	—	—	— (2)
161385	—	161385	—	—	—	—	—	—	—	—	—	— (3)
574069	—	574226	—	‡574461	‡574460	574635	574720	574635	574635	574635	574635	574635 (4)
574064	—	—	—	—	—	572289	198889	572289	572289	572289	572289	572289 (5)
—	—	574255	—	—	—	—	—	—	—	—	—	— (6)
574065	—	575640	—	574451	574451	574634	574722	574634	574634	574634	574634	574634 (7)
—	—	—	—	574456	574457	—	—	—	—	—	—	— (8)
—	—	—	‡572804	—	—	—	574726	—	—	—	—	— (9)
—	—	—	—	—	—	—	574725	—	—	—	—	— (10)
573828	—	573828	552101	552101	552101	—	552101	—	—	—	—	— (11)
573832	—	—	—	552103	552103	—	552103	—	—	—	—	— (12)
380	—	380	380	380	380	380	380	380	380	380	380	380 (13)
382	—	—	—	382	382	—	382	—	—	—	—	— (14)
—	—	574231	571758	—	—	574637	574721	574646	574646	574646	574646	574890 (15)
555910	—	—	188818	555910	555910	555910	555910	555910	555910	555910	555910	555910 (16)
—	—	—	‡571738	—	—	—	‡571738	—	—	—	—	— (17)
574075	—	574224	—	—	—	—	—	—	—	—	—	— (18)
—	—	—	—	—	—	—	—	—	—	—	—	— (19)
—	—	—	—	—	—	—	—	—	—	—	—	— (20)
—	—	—	—	—	—	126544	—	147924	147884	147924	147884	— (21)
—	—	—	—	166019	166019	—	166019	—	—	—	—	— (22)
573825	—	—	—	188330	188330	—	188330	**505652	**505652	**505652	**505652	— (23)

	53464A 548 C.P.R. —	53465B/E 572 C.P.R. —	†53479A/D 558 C.P.R. (53356)	53489A 583 C.P.R. —	53495B 553 Chromium —	53516D 553 Chromium —	53522D 553 Chromium —	53527A/B 548 C.P.R. —	53539A/D 572 Chromium —	53540A/D 572 Chromium —	53541B/E 523 — —	53547A/B 587 C.P.R. —
574560	—	—	574874	576183	—	—	—	574560	—	—	—	576277 (1)
113061	—	—	121501	572289	—	—	—	113061	—	—	—	156726 (2)
574558	—	—	—	—	—	—	—	574558	—	—	—	— (3)
161385	—	—	161385	—	—	—	—	161385	—	—	161385	188330 (4)
574546	—	—	575581	575473	574720	574946	574945	—	—	—	574069	— (5)
—	54570777	—	—	—	—	—	—	54571072	576588	576588	—	576267 (6)
574547	575760	—	—	576184	—	—	—	54571070	576586	576586	—	576268 (7)
—	—	—	—	—	—	—	—	—	—	—	—	576273 (8)
—	198889	—	—	—	198889	198889	198889	—	198924	198924	574064	198917 (9)
—	—	—	—	574616	—	—	—	—	—	—	—	— (10)
574548	575765	574884	—	†574065	574722	574722	574722	574548	576582	576582	574065	576265 (11)
°574549	°575766	—	—	‡576189	—	—	—	—	—	—	—	— (12)
—	—	574886	—	575471	—	—	—	—	—	—	—	— (13)
—	—	—	—	—	574726	574726	574726	574566	—	—	—	‡555925 (14)
574559	556284	—	—	—	574725	574725	574725	—	—	—	—	‡556284 (15)
573828	552101	552101	573828	552101	552101	552101	573828	573828	573828	573828	573828	573828 (16)
573832	552103	552103	573832	552103	552103	552103	573832	573832	573832	573832	573832	573832 (17)
380	380	380	380	380	380	380	380	380	380	380	380	380 (18)
382	382	382	382	382	382	382	382	382	382	382	382	382 (19)
°°574554	575769	—	—	574607	574721	574721	574721	574550	575769	575769	—	576266 (20)
188818	555910	555910	555910	555910	555910	555910	555910	188818	—	—	555910	555909 (21)
—	—	574889	—	—	—	—	—	—	—	—	—	— (22)
—	—	575580	—	—	—	—	—	—	—	—	—	— (23)
—	—	574885	—	—	—	—	—	—	—	—	—	— (24)
574552	—	—	—	—	—	—	—	608610	—	—	—	— (25)
—	—	—	—	—	‡571738	‡571738	‡571738	132464	—	—	—	— (26)
—	—	—	—	—	—	—	—	188412	—	—	—	— (27)
—	—	—	—	—	—	—	—	574554	—	—	—	— (28)
574550	576598	—	—	—	—	—	—	—	576583	576593	574075	— (29)
—	—	—	—	576188	—	—	—	—	576596	576596	—	— (30)
—	—	—	—	—	—	—	—	—	577310	577310	—	— (31)
—	—	—	—	—	—	—	—	—	161385	161385	—	— (32)
—	—	—	—	—	—	—	—	—	—	—	—	— (33)
—	—	—	—	—	—	—	—	—	—	—	—	— (34)
132464	—	—	—	‡574606	—	—	—	‡574549	—	—	—	— (35)
—	—	—	—	186137	—	—	—	—	—	—	—	— (36)
—	166019	—	—	—	166019	166019	166019	—	166019	166019	—	— (37)
188412	188330	—	—	—	188330	188330	188330	—	188330	188330	—	— (38)
—	—	—	—	573825	—	—	—	—	199001	199001	573825	573825 (39)
—	—	—	—	—	—	—	—	—	‡554925	‡554925	—	— (40)
—	—	—	—	—	—	—	—	—	516285	516285	—	— (41)

For illustrations, see pages K37-K39

† When ordering, quote part number shown in brackets ‡ With lens †† Includes dust cover 574445 ‡ Shell only § Ring, bulb holder shell fixing continued
 ° Lower lens seating ** Ring, securing, body fixing screw ††† Lens seating ††† Rim seating §§ Retainer, wire ‡‡ Stop tail lens §§ Double
 °° Gasket reverse bulb holder C.P.R. .. Chromium plated rim

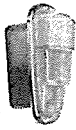

STOP TAIL AND FLASHER LAMPS

DETAILED SPARE PARTS

Part No.	53547D/H	53553B/D	53554B/D	**53564D	53565D/F	53576A	53577A	53579B/E
Model	587	589	589	594	593	549	549	593
Finish	C.P.R.	—	—	C.P.R.	Chromium	Chromium	Chromium	Chromium
Replaced by (see footnote)	—	—	—	—	—	—	—	—
(1) §Rim	576277	—	—	572734	—	—	—	—
(2) Screw or nut, rim fixing	156726	—	—	—	—	—	—	—
(3) Washer, retaining	188330	—	—	—	—	—	—	—
(4) §Lens	—	576934	576933	576109	54570766	574635	574635	54570767
(5) §Lens, stop tail or outer	576267	—	—	—	54570085	—	—	54570085
(6) §Lens, flasher or inner	576268	—	—	—	576955	—	—	576956
(7) Strap, lens or reflex retaining	576273	—	—	—	—	—	—	—
(8) Screw, strap or lens fixing	198903	—	—	—	198929	572289	572289	198929
(9) §Ring, sliding	—	—	—	—	—	—	—	—
(10) §Gasket, lens or rim seating	576265	576936	576936	—	576777	574634	574634	576777
(11) Bezel, lens fixing	—	576941	576941	—	—	—	—	—
(12) Bracket, bulb holder	—	—	—	—	—	—	—	—
(13) §Bulb holder (stop tail)	54570089	576937	576937	576985	555384	—	—	555384
(14) §Bulb holder (flasher)	54570088	576938	576938	—	556284	—	—	556284
(15) §Interior (stop tail)	573828	573828	573828	552101	552101	—	—	552101
(16) §Interior (flasher)	573832	573832	573832	—	552103	—	—	552103
(17) §Bulb (stop tail)	380	380	380	380	380	380	380	380
(18) §Bulb (flasher)	382	382	382	—	382	—	—	382
(19) §Gasket, body seating	576266	—	—	—	576776	576731	576730	576776
(20) §Sleeve, terminal	555909	—	—	555910	—	555910	555910	—
(21) Plate, steel, masking	—	—	—	—	—	—	—	—
(22) §Seal, rubber, masking	—	—	—	—	—	—	—	—
(23) Base or body	—	—	—	576105	576775	576725	576724	576775
(24) Plate, bulb holder or backplate	—	—	—	—	—	—	—	—
(25) Screw, fixing, plate or nut	—	—	—	—	—	—	—	—
(26) Washer, retaining screw	—	—	—	—	—	—	—	—
(27) Shield, light	—	576935	576935	—	576958	—	—	576958
(28) Plate, lens mounting	—	—	—	—	—	—	—	—
(29) Screw, lamp or base fixing	—	—	—	—	—	—	—	—
(30) Nut, lamp or base fixing	—	—	—	—	156726	—	—	156726
(31) Washer, locking	—	—	—	—	188330	—	—	188330
(32) §Grommet, cable entry	573825	—	—	—	576401	—	—	576401
(33) Washer, cable grip	—	—	—	—	—	—	—	—

Part No.	53660A	53663A	53664A	53665A	53666A	53685A/B	53689A/B	53694B/D
Model	558	596	596	596	596	572	548	600
Finish	C.P.R.	C.P.R.	C.P.R.	C.P.R.	C.P.R.	Chromium	C.P.R.	C.P.R.
Replaced by (see footnote)	—	—	—	—	—	—	—	—
(1) §Rim	574874	577601	577116	577601	577116	—	574560	577151
(2) Screw or nut, rim fixing	572072	186130	186130	186130	186130	—	113061	—
(3) Screw, rim fixing, long	—	—	—	—	—	—	574558	—
(4) Washer, retaining	—	—	—	—	—	—	161385	161385
(5) Bracket, retaining	—	—	—	—	—	—	—	—
(6) §Lens	575584	576337	576337	576338	576338	—	—	577156
(7) §Lens, stop tail or outer	—	—	—	—	—	54570777	54571072	—
(8) §Lens, flasher or inner	—	—	—	—	—	575763	54571071	—
(9) Strap, lens or reflex retaining	—	576334	576334	576334	576334	—	—	—
(10) Screw, strap or lens fixing	—	—	—	—	—	198889	—	106501
(11) Clip, lens joint	—	—	—	—	—	—	—	—
(12) §Gasket, lens or rim seating	574884	576335	576335	576335	576335	575765	574549	577152
						575766	574548	
(13) Bracket, bulb holder	574886	—	—	—	—	—	—	—
(14) §Bulb holder (stop tail)	—	—	—	—	—	—	574566	—
(15) §Bulb holder (flasher)	—	—	—	—	—	—	—	—
(16) §Interior (stop tail)	552101	573828	573828	573828	573828	552101	573828	552101
(17) §Interior (flasher)	552103	573832	573832	573832	573832	—	573832	552103
(18) §Bulb (stop tail)	380	380	380	380	380	380	380	380
(19) §Bulb (flasher)	382	382	382	382	382	382	382	382
(20) §Gasket, body seating	—	577602	577118	577602	577118	577311	574550	577146
(21) §Sleeve, terminal	555910	—	—	—	—	555910	188818	555910
(22) Plate, steel, masking	574889	—	—	—	—	—	—	—
(23) §Seal, rubber, masking	575580	—	—	—	—	—	—	—
(24) §Reflex reflector	—	—	—	—	—	—	608610	—
(25) Washer, rubber, reflex reflector seating	—	—	—	—	—	—	—	—
(26) §Screw, stop tail bulb holder fixing	—	—	—	—	—	—	132464	—
(27) Washer, shakeproof, fixing screw	—	—	—	—	—	—	188412	—
(28) §Gasket, stop tail bulb holder seating	—	—	—	—	—	—	574554	—
(29) Bracket, mounting, reflex reflector	—	—	—	—	—	—	—	—
(30) Cover, reflex	—	—	—	—	—	—	—	—
(31) Base or body	574885	—	—	—	—	575770	—	—
(32) Plate, bulb holder or backplate	—	—	—	—	—	—	—	—
(33) Screw, fixing, plate or nut	—	—	—	—	—	—	—	—
(34) Washer, retaining screw	—	—	—	—	—	—	—	—
(35) Shield, light	—	—	—	—	—	—	—	—
(36) Screw, lens mounting	—	—	—	—	—	—	—	—
(37) Plate, lens mounting	—	577605	577605	577605	577605	—	—	—
(38) §Screw, separator fixing	—	—	—	—	—	—	—	—
(39) Separator, upper	—	—	—	—	—	—	—	—
(40) Separator, lower	—	—	—	—	—	—	—	—
(41) §Plinth	—	—	—	—	—	—	—	—
(42) Screw, top fixing	—	—	—	—	—	—	—	—
(43) Bracket, lamp fixing	—	—	—	—	—	—	—	—
(44) Screw, lamp or base fixing	—	166019	166019	166019	166019	—	—	—
(45) Nut, lamp or base fixing	—	575623	575623	575623	575623	166019	—	—
		577105	577105	577105	577105	—	—	—
(46) Washer, locking	—	188330	188330	188330	188330	188330	—	—
(47) §Grommet, cable entry	—	859341	859341	859341	859341	—	—	—
(48) Washer, cable grip	—	576401	576401	576401	576401	—	—	—

For illustrations, see pages K37-K39

Note. For replacement lamp spare parts, see appropriate column under part number
 † Nut, locking § Grommet, double ** For illustrations, see page K52 ‡ Lower lens seating § Recommended spares for stock
 C.P.R. . . Chromium plated rim

STOP TAIL AND FLASHER LAMPS

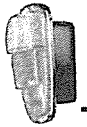

DETAILED SPARE PARTS

53586A/B 596 C.P.R.	53587A/B 596 C.P.R.	53596B/D 600 C.P.R.	53624A 538 C.P.R.	53634A 558 C.P.R.	53639A/B 570 C.P.R.	53640A/D 572 Chromium	53643A 587 C.P.R.	53643B/E 587 C.P.R.	†53648A/F 572 Chromium (53540)
576342	576342	577151	‡574259	574874	575365	—	576277	576277	— (1)
—	—	161385	—	121501	186136	—	156726	156726	— (2)
—	—	577153	574226	—	—	—	188330	188330	— (3)
576337	576338	—	—	575584	—	—	—	—	— (4)
—	—	—	—	—	54570762	576588	576267	576267	576588 (5)
—	—	—	—	—	575364	576586	576278	576278	576586 (6)
576334	576334	—	—	—	—	—	576273	576273	— (7)
—	—	106501	—	—	—	198924	198917	198917	198924 (8)
—	—	—	574255	—	—	—	—	576265	— (9)
576335	576335	577152	575640	574884	575368	576582	576265	576265	576582 (10)
—	—	—	—	—	575370	—	—	—	— (11)
—	—	—	—	574886	—	—	—	—	— (12)
—	—	—	—	—	—	—	555925	555925	— (13)
—	—	—	—	—	—	—	556284	556284	— (14)
—	—	—	—	—	574886	—	54570089	54570089	— (15)
—	—	—	—	—	—	—	54570088	54570088	— (16)
573828	573828	552101	573828	552101	552101	573828	573828	573828	573828 (17)
573832	573832	552103	—	552103	552103	573832	573832	573832	573832 (18)
380	380	380	380	380	380	380	380	380	380 (19)
382	382	382	382	382	382	382	382	382	382 (20)
577103	577103	577146	574231	—	575369	577311	576266	576266	575769 (21)
—	—	555910	—	555910	555910	—	555909	555909	— (22)
—	—	—	—	—	—	—	—	—	— (23)
—	—	—	574224	—	—	—	—	—	— (24)
—	—	—	—	574889	—	—	—	—	576593 (25)
—	—	—	—	575580	—	—	—	—	576596 (26)
—	—	—	—	574885	—	—	—	—	577310 (27)
—	—	—	—	—	—	576593	—	—	161385 (28)
—	—	—	—	—	—	576596	—	—	— (29)
—	—	—	—	—	—	577310	—	—	— (30)
—	—	—	—	—	—	161385	—	—	— (31)
—	—	—	—	—	—	—	—	—	— (32)
576343	576343	—	—	—	—	—	—	—	— (33)
§166019	§166019	—	—	—	—	—	—	—	— (34)
575623	575623	—	—	—	—	166019	—	—	166019 (35)
577105	577105	—	—	—	—	—	—	—	— (36)
188330	188330	—	—	—	—	—	—	—	— (37)
859341	859341	—	—	—	—	188330	—	—	188330 (38)
**576401	**576401	—	576401	—	—	199001	573825	573825	199001 (39)
—	—	—	—	—	—	516285	—	—	516285 (40)
—	—	—	—	—	—	††554925	—	—	††554925 (41)

53695A/B 572 Chromium	53703A/D 616 C.P.R.	53704A/D 616 C.P.R.	53710A/B 570 C.P.R.	53711A/H 620 C.P.R.	53712B/D 621 Chromium	53713B/D 621 Chromium	†53715A/B 572 Chromium (53539)	53726A/B 627 Chromium	53727A/B 627 Chromium	53728A 627 Chromium
—	—	—	575365	54570221	—	—	—	—	—	— (1)
—	—	—	186136	113531	—	—	—	—	—	— (2)
—	—	—	—	—	—	—	—	—	—	— (3)
—	—	—	—	161385	—	—	—	—	—	— (4)
—	—	—	—	577731	—	—	—	—	—	— (5)
—	—	—	—	—	—	—	—	—	—	— (6)
54570777	54570081	54570081	54570762	577729	54570150	54570150	576588	54570229	54570229	54570229 (7)
575760	54570076	54570082	54570118	577728	54570099	54570251	576586	54570227	54570227	54570227 (8)
—	—	—	—	577730	—	—	—	—	—	— (9)
198889	198924	198924	—	186134	198924	198924	198924	54110161	54110161	54110161 (10)
—	—	—	—	—	—	—	—	54570230	54570230	54570230 (11)
575765	54570079	54570079	575368	††577726	54570102	54570102	576582	54570233	54570233	54570233 (12)
††575766	—	—	575370	577725	—	—	—	—	—	— (13)
—	—	—	—	—	—	—	—	—	—	— (14)
556284	54571314	54571314	555384	—	54571314	54571314	—	—	—	— (15)
—	54571313	54571313	556284	—	54571313	54571313	—	—	—	— (16)
552101	573828	573828	552101	573828	573828	573828	573828	573828	573828	573828 (17)
552103	573832	574832	552103	573832	573832	573832	573832	573832	573832	573832 (18)
380	380	380	380	380	380	380	380	380	380	380 (19)
382	382	382	382	382	382	382	382	382	382	382 (20)
575769	§§54570505	§§54570505	575369	577724	54570104	54570104	575769	54572361	54572361	54570301 (21)
—	54570506	54570506	—	—	—	—	—	—	—	— (22)
555910	—	—	555910	555910	—	—	—	—	—	— (23)
—	—	—	—	—	—	—	—	—	—	— (24)
—	—	—	—	577737	—	—	—	574914	574914	574914 (25)
—	—	—	—	—	—	—	—	574916	574916	574916 (26)
—	—	—	—	—	—	—	—	§§133226	§§133226	§§186136 (27)
—	—	—	—	—	—	—	—	§§188412	§§188412	§§188412 (28)
—	—	—	—	—	—	—	—	—	—	— (29)
—	—	—	—	577733	—	—	—	54570236	54570236	54570236 (30)
575770	54570075	54570075	—	—	54570252	54570252	576583	—	—	— (31)
—	—	—	—	—	—	—	576596	—	—	— (32)
—	—	—	—	—	—	—	577310	—	—	— (33)
—	—	—	—	—	—	—	161385	—	—	— (34)
—	—	—	—	—	—	—	—	—	—	— (35)
—	—	—	—	—	—	—	—	54570231	54570231	54570231 (36)
—	—	—	—	—	—	—	—	54120034	54120034	54120034 (37)
—	—	—	—	—	—	—	—	54570296	54570296	54570296 (38)
—	—	—	—	—	198924	198924	—	—	—	— (39)
—	—	—	—	—	54570105	54570105	—	—	—	— (40)
—	—	—	—	—	54570106	54570106	—	—	—	— (41)
—	—	—	—	—	—	—	—	—	—	— (42)
—	—	—	—	—	—	—	—	54570291	54570292	54570299 (43)
—	—	—	—	—	—	—	—	147806	147806	147806 (44)
—	—	—	—	—	—	—	—	54570293	54570555	54570293 (45)
166019	—	—	—	—	—	—	—	192256	192256	120376 (46)
188330	—	—	—	—	—	—	—	—	—	— (47)
—	573825	573825	—	—	188483	188483	188330	—	—	— (48)
—	—	—	—	576401	573825	573825	199001	—	—	— (49)
—	—	—	—	—	—	—	516285	—	—	— (50)
—	—	—	—	—	—	—	††554925	—	—	— (51)

For illustrations, see pages K37-K39

† When ordering, quote part number shown in brackets ‡ With lens § Inner ¶ Outer °Shell only § Nut, locking continued
 ** Grommet, double entry †† Double ‡‡ Lower lens seating §§ Upper ¶¶ Lower §§ Fixing bracket °° Reverse C.P.R. . . Chromium plated rim



STOP TAIL AND FLASHER LAMPS

DETAILED SPARE PARTS

Part No.	53729A	53738A	53739A	53750A/B	53751A/B	53752A/F	53753A/B	53754A/B
Model	627	627	627	629	629	572	572	572
Finish	Chromium	Chromium	Chromium	Chromium	Chromium	Chromium	Chromium	Chromium
Replaced by (see footnote)	—	—	—	—	—	—	—	—
(1) §Rim	—	—	—	—	—	—	—	—
(2) Screw or nut, rim fixing	—	—	—	—	—	—	—	—
(3) §Lens, reverse	—	—	—	54570255	54570255	—	—	—
(4) §Lens, stop tail or outer	54570229	54570229	54570229	54570581	54570581	576588	576588	576588
(5) §Lens, flasher or inner	54570227	54570227	54570227	54570257	54570507	54570335	54570335	54570335
(6) Screw, strap or lens fixing	54110161	54110161	54110161	198929	198929	198924	198924	198924
(7) Clip, lens joint	54570230	54570230	54570230	—	—	—	—	—
(8) §Gasket, lens or rim seating	54570233	54570233	54570233	54570035	54570035	576582	576582	576582
(9) §Bulb holder (stop tail)	—	—	—	54571314	54571314	—	—	—
(10) §Bulb holder (flasher)	—	—	—	54571313	54571313	—	—	—
(11) §Interior (stop tail)	573828	573828	573828	573828	573828	573828	573828	573828
(12) §Interior (flasher)	573832	573832	573832	573832	573832	573832	573832	573832
(13) §Bulb (stop tail)	380	380	380	380	380	380	380	380
(14) §Bulb (flasher)	382	382	382	382	382	382	382	382
(15) §Gasket, body seating	54570302	54570315	54570316	54570007	54570007	575769	575769	577311
(16) §Sleeve, terminal	—	—	—	—	—	—	—	—
(17) §Reflex reflector	574914	574914	574914	575883	575883	—	—	—
(18) Washer, rubber, reflex reflector seating	574916	54571600	54571600	—	—	—	—	—
(19) §Screw, bracket fixing	54120034	54120034	54120034	—	—	—	—	—
(20) Washer, fixing screw	188412	188412	188412	—	—	—	—	—
(21) Gasket, reflex support	—	—	—	54570429	54570429	—	—	—
(22) Bracket or frame, reflex reflector	54570236	54570236	54570236	54570428	54570428	—	—	—
(23) Base or body	—	—	—	54571736	54571736	576583	576593	576593
(24) Plate, bulb holder or backplate	—	—	—	—	—	576596	576596	576596
(25) Screw, plate fixing, or nut	—	—	—	—	—	577310	577310	577310
(26) Washer, retaining screw	—	—	—	—	—	161385	161385	161385
(27) Shield, light	54570231	54570231	54570231	—	—	—	—	—
(28) Screw, lens mounting	54120034	54120034	54120034	—	—	—	—	—
(29) Plate, lens mounting	54570296	54570296	54570296	—	—	—	—	—
(30) §Rib, styling	—	—	—	54570420	54570420	—	—	—
(31) Screw, styling rib fixing	—	—	—	198924	198924	—	—	—
(32) §Gasket, styling rib seating	—	—	—	54571737	54571737	—	—	—
(33) §Gasket, lens wall	—	—	—	54571738	54571738	—	—	—
(34) §Screw, separator fixing	—	—	—	54110186	54110186	—	—	—
(35) Separator	—	—	—	54570258	54570258	—	—	—
(36) §Plinth	54570300	54570417	54570414	—	—	—	—	—
(37) Screw, top fixing	147806	186136	186136	—	—	—	—	—
(38) Bracket, lamp fixing	54570555	54570415	54570415	—	—	—	—	—
(39) Screw, lamp or base fixing	120376	§54570416	§54570561	—	—	—	—	—
(40) Nut, lamp or base fixing	—	120376	120376	—	—	—	—	—
(41) Washer, locking	—	—	—	—	—	166019	166019	166019
(42) §Grommet, cable entry	—	—	—	573825	573825	188330	188330	188330
(43) Washer, cable grip	—	—	—	—	—	199001	199001	199001
	—	—	—	—	—	516285	516285	516285
	—	—	—	—	—	**554925	**554925	**554925

Part No.	53772A/B	53774A/B	53775A/B	53776A/B	53777A/B	53779A	53790A/D	53791A/D
Model	636	640	640	641	641	642	635	635
Finish	—	Chromium	Chromium	Chromium	Chromium	—	Chromium	Chromium
Replaced by (see footnote)	—	—	—	—	—	—	—	—
(1) §Rim	—	—	—	—	—	—	—	—
(2) Screw or nut, rim fixing	—	—	—	—	—	—	—	—
(3) Screw, rim fixing, long	—	—	—	—	—	—	—	—
(4) Washer, retaining	161385	—	—	—	—	—	—	—
(5) Bracket, rim retaining	—	—	—	—	—	—	—	—
(6) §Lens	54570562	—	—	—	—	—	—	—
(7) §Lens, stop tail or outer	—	54570181	54570181	54570787	54570787	54570437	†54570667	†54570667
(8) §Lens, flasher or inner	—	54570179	54570400	54570751	54570425	54570436	54570631	54570631
(9) Strap, lens or reflex retaining	—	—	—	—	—	—	54570629	54570668
(10) Screw, strap or lens fixing	144921	198924	198924	198924	198924	198924	198929	198929
(11) Clip, lens joint	54570331	—	—	—	—	—	—	—
(12) §Gasket, lens or rim seating	54570332	54570743	54570743	54570743	54570743	54570220	54570639	54570639
(13) §Bulb holder (stop tail)	—	54571314	54571314	54571314	54571314	54570461	54571314	54571314
(14) §Bulb holder (flasher)	—	54571313	54571313	54571313	54571313	54570460	†54571313	†54571313
(15) §Interior (stop tail)	573828	573828	573828	573828	573828	—	54571313	54571313
(16) §Interior (flasher)	573832	573832	573832	573832	573832	—	573828	573828
(17) §Bulb (stop tail)	380	380	380	380	380	380	†573832	†573832
(18) §Bulb (flasher)	382	382	382	382	382	382	380	380
(19) §Gasket, body seating	—	54570742	54570742	54570742	54570742	54570476	382	382
(20) §Sleeve, terminal	555910	—	—	—	—	—	54570640	54570640
(21) §Reflex reflector	—	—	—	—	—	—	—	—
(22) Cover, reflex	—	—	—	—	—	—	—	—
(23) Base or body	54570368	54570360	54570360	54570360	54570360	54570246	54570653	54570653
(24) Shield, light	—	54570182	54570182	54570750	54570750	54570247	—	—
(25) Screw, lens mounting	—	—	—	—	—	—	—	—
(26) §Screw, separator fixing	—	—	—	—	—	—	186134	186134
(27) Separator	—	—	—	—	—	—	54570636	54570636
(28) Nut, lamp or base fixing	—	—	—	—	—	—	—	—
(29) Washer, locking	—	—	—	—	—	—	—	—
(30) §Grommet, cable entry	—	573825	573825	573825	573825	—	573825	573825
(31) Washer, cable grip	516285	—	—	—	—	—	—	—
	**554925	—	—	—	—	—	—	—

For illustrations, see pages K37-K39

Note. For replacement lamp spare parts, see appropriate column under part number † Reverse § Recommended spares for stock
 § Centre bracket ** Double

STOP TAIL AND FLASHER LAMPS



DETAILED SPARE PARTS

53755A 627 Chromium	53756A 627 Chromium	53757A/B 627 Chromium	53758A/B 627 Chromium	53759A 627 Chromium	53760A 627 Chromium	53762A 631 C.P.R.	53769A 631 C.P.R.	53770A/D 635 Chromium	53771A/D 635 Chromium
—	—	—	—	—	—	577853	577853	—	— (1)
—	—	—	—	—	—	186137	186137	—	— (2)
54570229	54570229	54570229	54570229	54570229	54570229	577857	577857	54570667	54570667 (3)
54570228	54570228	54570228	54570228	54570228	54570228	577854	54570318	54570631	54570631 (4)
54110161	54110161	54110161	54110161	54110161	54110161	—	—	54570629	54570668 (5)
54570230	54570230	54570230	54570230	54570230	54570230	—	—	198929	198929 (6)
54570233	54570233	54570233	54570233	54570233	54570233	577859	577859	54570639	54570639 (8)
—	—	—	—	—	—	54571870	54571870	54571314	54571314 (9)
—	—	—	—	—	—	—	—	54571313	54571313 (10)
573828	573828	573828	573828	573828	573828	556101	556101	54571313	54571313 (10)
—	—	—	—	—	—	552101	552101	573828	573828 (11)
573832	573832	573832	573832	573832	573832	552103	552103	573832	573832 (12)
380	380	380	380	380	380	380	380	380 †382	380 †382 (13)
382	382	382	382	382	382	382	382	382	382 (14)
54570315	54570316	54572361	54572361	54570301	54570302	577860	577860	54570640	54570640 (15)
—	—	—	—	—	—	555910	555910	—	— (16)
574914	574914	574914	574914	574914	574914	—	—	—	— (17)
54571600	54571600	574916	574916	574916	574916	—	—	—	— (18)
54120034	54120034	133226	133226	186136	186136	—	—	—	— (19)
188412	188412	188412	188412	188412	188412	—	—	—	— (20)
—	—	—	—	—	—	—	—	—	— (21)
54570236	54570236	54570236	54570236	54570236	54570236	—	—	—	— (22)
—	—	—	—	—	—	—	—	54570635	54570635 (23)
—	—	—	—	—	—	—	—	—	— (24)
—	—	—	—	—	—	—	—	—	— (25)
—	—	—	—	—	—	—	—	—	— (26)
54570231	54570231	54570231	54570231	54570231	54570231	—	—	—	— (27)
54120034	54120034	54120034	54120034	54120034	54120034	—	—	—	— (28)
54570296	54570296	54570296	54570296	54570296	54570296	—	—	—	— (29)
—	—	—	—	—	—	—	—	—	— (30)
—	—	—	—	—	—	—	—	—	— (31)
—	—	—	—	—	—	—	—	—	— (32)
—	—	—	—	—	—	—	—	—	— (33)
—	—	—	—	—	—	—	—	186134	186134 (34)
54570417	54570414	54570291	54570292	54570299	54570300	—	—	54570636	54570636 (35)
186136	186136	147806	147806	147806	147806	—	—	—	— (36)
54570415	54570415	54570293	54570555	54570293	54570555	—	—	—	— (37)
§54570416	§54570561	—	—	—	—	—	—	—	— (38)
120376	120376	192256	192256	120376	120376	—	—	—	— (39)
—	—	—	—	—	—	—	—	—	— (40)
—	—	—	—	—	—	—	—	—	— (41)
—	—	—	—	—	—	—	—	573825	573825 (42)
—	—	—	—	—	—	—	—	—	— (43)

53792A/E 646 Chromium	53793A/E 646 Chromium	53794A/E 646 Chromium	53795A/E 646 Chromium	53797A/B 647	53798A/B 647	53799A/B 647	53800A/B 647	53801A 642	53815A/E 620 C.P.R.	53816A/B 636
—	—	—	—	**54570454	**54570454	**54570454	**54570454	—	54570221	— (1)
—	—	—	—	**54570453	**54570453	**54570453	**54570453	—	113531	— (2)
—	—	—	—	161385	161385	161385	161385	—	—	— (3)
—	—	—	—	—	—	—	—	—	161385	161385 (4)
—	—	—	—	—	—	—	—	—	577731	— (5)
54570544	54570544	54570544	54570544	54570749	54570678	54570749	54570678	54570437	577729	54570923 (6)
54570495	54570495	54570810	54570810	54570466	54570451	54571013	54571012	54570648	577730	— (7)
—	—	—	—	—	—	—	—	—	577730	— (8)
54120022	54120022	54120022	54120022	††54570455	††54570455	††54570455	††54570455	198924	186194	144921 (10)
54570604	54570604	54570604	54570604	54570450	54570450	54570450	54570450	54570220	577725	54570331 (11)
54571314	54571314	54571314	54571314	—	—	—	—	54570461	††577726	54570332 (12)
54571313	54571313	54571313	54571313	—	—	—	—	—	—	— (13)
573828	573828	573828	573828	573828	573828	573828	573828	54570460	—	— (14)
—	—	—	—	—	—	—	—	—	573828	573828 (15)
573832	573832	573832	573832	573832	573832	573832	573832	—	573832	573832 (16)
380	380	380	380	380	380	380	380	380	380	380 (17)
382	382	382	382	382	382	382	382	382	382	382 (18)
54570604	54570604	54570604	54570604	54571330	54571330	54571330	54571330	54570476	577724	54570332 (19)
—	—	—	—	—	—	—	—	—	555910	555910 (20)
—	—	—	—	—	—	—	—	—	577737	— (21)
54570616	54570617	54570616	54570617	54570747	54570446	54570747	54570446	54570246	577733	54570368 (23)
54570496	54570496	54570496	54570496	—	—	—	—	54570247	—	— (24)
—	—	—	—	—	—	—	—	—	—	— (25)
—	—	—	—	54570814	54570815	54570814	54570815	—	—	— (26)
—	—	—	—	—	—	—	—	—	—	— (27)
156726	156726	156726	156726	—	—	—	—	—	—	— (28)
188330	188330	188330	188330	—	—	—	—	—	—	— (29)
573825	573825	573825	573825	573825	573825	573825	573825	—	576401	— (30)
—	—	—	—	—	—	—	—	—	—	— (31)
—	—	—	—	—	—	—	—	—	—	§§54925

For illustrations, see pages K37–K39

† Reverse C.P.R. § Centre bracket Chromium plated rim or base ** Flasher lens fixing †† Stop tail lens fixing †‡ Lower lens seating §§ Double continued

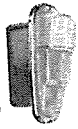

STOP TAIL AND FLASHER LAMPS

DETAILED SPARE PARTS

Part No.	53823A/B	53824A/B	53833A	53838A	53839A	53846A	058619	058647
Model	654	654	657	549	549	657	539/551	538/551
Finish	Chromium	Chromium	Chromium	C.P.R.	C.P.R.	Chromium	C.P.R.	C.P.R.
Replaced by (see footnote)	—	—	—	—	—	—	—	—
§Rim	—	—	—	574654	574655	—	‡574610 575644	‡574610 574250
§Lens	—	—	—	574635	574635	—	—	—
§Lens, stop tail or outer	54570959	54570959	54570990	—	—	54570990	574609	574609
§Lens, flasher or inner	54570589	54571036	54570929	—	—	54571199	574256	574226
Screw, strap or lens fixing	198924	198924	114501	572289	572289	114501	—	—
§Ring, sliding	—	—	—	—	—	—	‡574616 574255	‡574616 574255
§Gasket, lens or rim seating	54570590	54570590	54570937	574634	574634	54570937	‡576805 574225	‡576805 574225
Bracket, bulb holder	—	—	—	—	—	—	575476	575476
§Bulb holder (stop tail)	54570089	54570089	—	—	—	—	—	—
§Bulb holder (flasher)	54570088	54570088	—	—	—	—	—	—
§Interior (stop tail)	573828	573828	573828	—	—	573828	573828	573828
§Interior (flasher)	573832	573832	573832	—	—	573832	573832	573832
§Bulb (stop tail)	380	380	380	380	380	380	380	380
§Bulb (flasher)	382	382	382	—	—	382	382	382
§Gasket, body seating	54570591	54570591	54570937	54571147	54571147	54570937	‡574627 575637	‡574627 575637
§Sleeve, terminal	—	—	—	555910	555910	—	—	—
Base or body	54571050	54571050	54570989	—	—	54570989	—	—
Nut, lamp or base fixing	166019	166019	—	—	—	—	—	—
Washer, locking	188330	188330	—	—	—	—	—	—
§Grommet, cable entry	—	—	573825	—	—	573825	573825	573825
Washer, cable grip	516285	516285	—	—	—	—	—	—
Lens, decorative, front	‡554925	‡554925	—	—	—	—	*574245	*574245
Lens, decorative, rear	—	—	—	—	—	—	*574260	*574260

597 MODELS

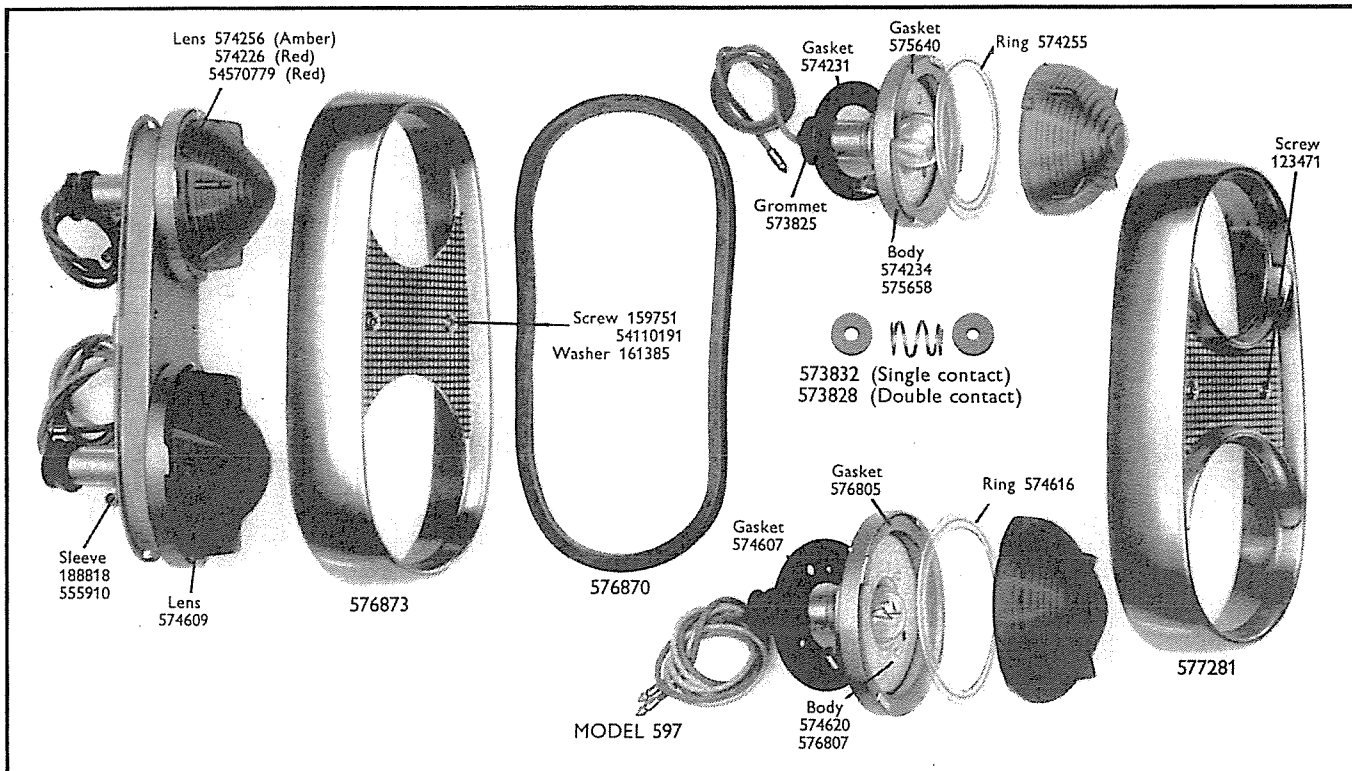

Note. For replacement lamp spare parts, see appropriate column under part number
 † Double ‡ Order separately C.P.R. . . . Chromium plated rim

‡ Stop tail

§ Recommended spares for stock

continued

STOP TAIL AND FLASHER LAMPS—Model 597



DETAILED SPARE PARTS

Part No.	53588A	53588B	53588E/F	53590A	53590B	53590E/F	53590H	†53591A
Model	597	597	597	597	597	597	597	597
Finish	C.P.R.	C.P.R.	C.P.R.	C.P.R.	C.P.R.	C.P.R.	C.P.R.	C.P.R.
Replaced by (see footnote)	—	—	—	—	—	—	—	(53669)
§Rim and plate	576873	576873	576873	576873	576873	576873	576873	576873
§ Screw, rim fixing	159751	159751	54110191	159751	159751	54110191	54110191	159751
Washer, screw retaining	161385	161385	161385	161385	161385	161385	161385	161385
§Gasket, rim seating	576870	576870	576870	576870	576870	576870	576870	576870
§Lens (flasher)	574256	574256	574256	574226	574226	574226	54570779	574256
§Ring, sliding (flasher)	574255	574255	574255	574255	574255	574255	574255	574255
§Gasket, lens seating (flasher)	575640	575640	575640	575640	575640	575640	575640	575640
§Gasket, body seating (flasher)	574231	—	574231	574231	—	574231	574231	574231
Body (flasher)	574234	575658	575658	574234	575658	575658	575658	574234
§ Interior, bulb holder (flasher)	573832	573832	573832	573832	573832	573832	573832	573832
§Lens, stop tail and reflex	574609	574609	574609	574609	574609	574609	574609	574609
§Ring, sliding (stop tail)	574616	574616	574616	574616	574616	574616	574616	574616
§Gasket, lens seating (stop tail)	576805	576805	576805	576805	576805	576805	576805	576805
§Gasket, body seating (stop tail)	574607	—	574607	574607	—	574607	574607	574607
Body (stop tail)	574620	576807	576807	574620	576807	576807	576807	574620
§ Interior, bulb holder (stop tail)	573828	573828	573828	573828	573828	573828	573828	573828
§Grommet, bulb holder	573825	573825	573825	573825	573825	573825	573825	573825
Screw, fixing	186137	186137	186137	186137	186137	186137	186137	—
§Sleeve, terminal	555910	555910	555910	188818	555910	555910	555910	188818
§Bulb (flasher)	382	382	382	382	382	382	382	382
§Bulb (stop tail)	380	380	380	380	380	380	380	380
Screw, lamp fixing	126643	126643	—	126643	126643	—	—	—

Part No.	†53591K	†53591M	†53593A	†53593K	†53593M	†53593N	53669A	53671A
Model	597	597	597	597	597	597	597	597
Finish	C.P.R.	C.P.R.	C.P.R.	C.P.R.	C.P.R.	C.P.R.	C.P.R.	C.P.R.
Replaced by (see footnote)	(53669)	(53669)	(53671)	(53671)	(53671)	(53671)	—	—
§Rim and plate	577281	577281	576873	577281	577281	577281	577281	577281
§ Screw, rim fixing	123471	123471	159751	123471	123471	123471	123471	123471
Washer, screw retaining	161385	161385	161385	161385	161385	161385	161385	161385
§Gasket, rim seating	576870	—	576870	576870	—	—	—	—
§Lens (flasher)	574256	574256	574226	574226	574226	54570779	574256	574226
§Ring, sliding (flasher)	574255	574255	574255	574255	574255	574255	574255	574255
§Gasket, lens seating (flasher)	575640	575640	575640	575640	575640	575640	575640	575640
§Gasket, body seating (flasher)	—	574231	574231	—	574231	574231	—	—
Body (flasher)	575658	575658	574234	575658	575658	575658	575658	575658
§ Interior, bulb holder (flasher)	573832	573832	573832	573832	573832	573832	573832	573832
§Lens, stop tail and reflex	574609	574609	574609	574609	574609	574609	574609	574609
§Ring, sliding (stop tail)	574616	574616	574616	574616	574616	574616	574616	574616
§Gasket, lens seating (stop tail)	576805	576805	576805	576805	576805	576805	576805	576805
§Gasket, body seating (stop tail)	—	574607	574607	—	574607	574607	—	—
Body (stop tail)	576807	576807	574620	576807	576807	576807	576807	576807
§ Interior, bulb holder (stop tail)	573828	573828	573828	573828	573828	573828	573828	573828
§Grommet, bulb holder	573825	573825	—	573825	573825	573825	573825	573825
Screw, fixing	—	—	—	—	—	—	—	—
§Sleeve, terminal	555910	555910	188818	555910	555910	555910	555910	555910
§Bulb (flasher)	382	382	382	382	382	382	382	382
§Bulb (stop tail)	380	380	380	380	380	380	380	380
Screw, lamp fixing	—	—	—	—	—	—	—	—

For illustrations, see page K46

Note. For replacement lamp spare parts, see appropriate column under part number † When ordering, quote part number shown in brackets
 § Recommended spares for stock C.P.R. . . . Chromium plated rim

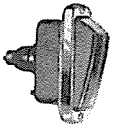

STOP TAIL AND REVERSE OR BOOT LAMPS

DETAILED SPARE PARTS

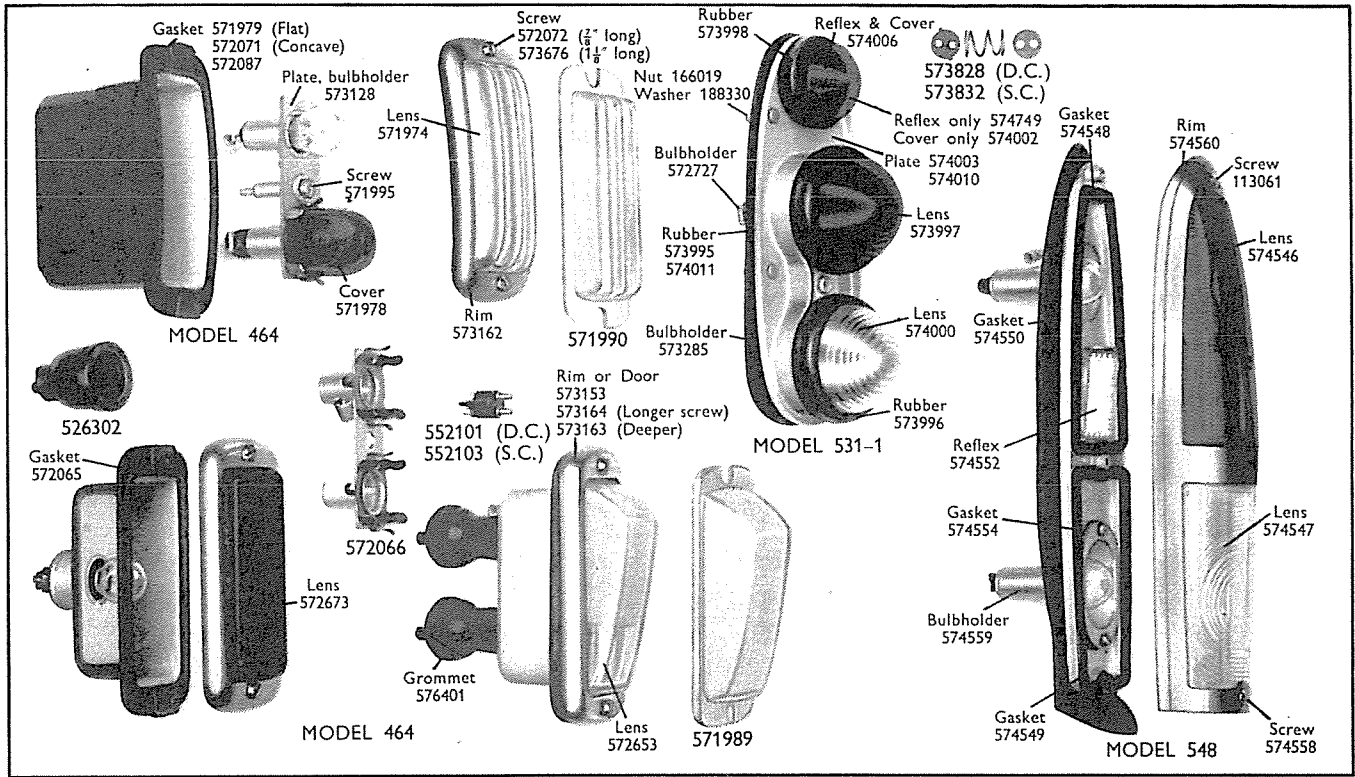

Part No.	†53092B	†53094E	53095F	†53098H	†53103E	†53115E	†53123F
Model	464	464	464	464	464	464	464
Finish	C.P.R.	C.P.R.	C.P.R.	C.P.R.	C.P.R.	C.P.R.	C.P.R.
Replaced by (see footnote)	(53175)	(53201)	—	(53179)	(53095)	(53177)	(53184)
§Rim or door	573162	573153	573153	573153	573153	573163	573153
§Screw, rim fixing	572072	572072	572072	572072	572072	572072	572072
§Washer, screw retaining	161385	161385	161385	161385	161385	161385	161385
§Lens (stop tail)	—	—	—	572673	—	—	—
§Lens (reverse)	571974	571990	571989	—	571989	571990	572653
§Gasket, rubber	571979	571979	571979	572065	571979	572071	572087
Reflex and cover	—	—	—	—	—	—	—
Reflex	—	—	—	—	—	—	—
Cover, reflex	—	—	—	—	—	—	—
Body, rubber, reflex	—	—	—	—	—	—	—
Mounting plate	—	—	—	—	—	—	—
§Cover, bulb	571978	571978	571978	—	571978	571978	571978
§Bulb holder (stop tail)	—	—	—	—	—	—	—
§Bulb holder (reverse)	—	—	—	—	—	—	—
§Interior, bulb holder (stop tail)	552101	552101	552103	552101	552103	552101	552101
§Interior, bulb holder (reverse)	552103	552101	†552103	—	552103	552103	552103
§Bulb (stop tail)	381	381	†382	381	207	381	381
§Bulb (reverse)	382	381	207	—	382	382	382
§Sleeve, terminal	188818	188818	188818	188818	188818	188818	188818
Plate, bulb holder	572066	—	572066	—	572066	—	—
Screw, bulb holder plate fixing	571995	—	571995	—	571995	—	—
§Nut, lamp fixing	—	—	—	—	—	—	—
Washer, lamp fixing	—	—	—	—	—	—	—
§Grommet, rubber	—	526302	—	—	—	526302	—
§Rubber, base	—	—	—	—	—	—	—

Note. For replacement lamp spare parts, see appropriate column under part number. † When ordering, quote part number shown in brackets.
 ‡ Stop § Recommended spares for stock || Tail C.P.R. . . Chromium plated rim

continued

STOP TAIL AND REVERSE OR BOOT LAMPS

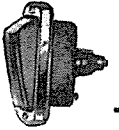

DETAILED SPARE PARTS

Part No.	53128F	†53142D	†53143B	53175B	53177B	53179E	53184B	53198B
Model	464	464	464	464	464	464	464	464
Finish	C.P.R.	C.P.R.	C.P.R.	C.P.R.	C.P.R.	C.P.R.	C.P.R.	C.P.R.
Replaced by (see footnote) . .	—	(53202)	(53203)	—	—	—	—	—
§Rim or door	573153	573164	573153	573162	573163	573153	573153	573153
§Screw, rim fixing	572072	573676	572072	572072	572072	572072	572072	572072
Washer, screw retaining	161385	161385	161385	161385	161385	161385	161385	161385
§Lens (stop tail)	—	—	—	—	—	572673	—	—
§Lens (reverse)	571990	571990	571990	571974	571990	—	572653	572653
§Gasket, rubber	571979	572087	571979	571979	572071	572065	572087	571979
Reflex and cover	—	—	—	—	—	—	—	—
Reflex	—	—	—	—	—	—	—	—
Cover, reflex	—	—	—	—	—	—	—	—
Body, rubber, reflex	—	—	—	—	—	—	—	—
Mounting plate	—	—	—	—	—	—	—	—
§Cover, bulb	—	571978	571978	571978	571978	—	571978	571978
§Bulb holder (stop tail)	—	—	—	—	—	—	—	—
§Bulb holder (reverse)	—	—	—	—	—	—	—	—
§Interior, bulb holder (stop tail)	—	552101	552101	552101	552101	552101	552101	552101
§Interior, bulb holder (reverse)	552103	552101	552103	552103	552103	—	552103	552103
§Bulb (stop tail)	—	381	381	380	380	380	380	380
§Bulb (reverse)	382	381	382	382	382	—	382	382
§Sleeve, terminal	555910	188818	188818	188818	188818	555910	188818	188818
Plate, bulb holder	—	—	—	573128	—	—	—	—
Screw, bulb holder plate fixing .	—	—	—	571995	—	—	—	—
§Nut, lamp fixing	—	—	—	—	—	—	—	—
Washer, lamp fixing	—	—	—	—	—	—	—	—
§Grommet, rubber	576401	—	526302	—	—	526302	—	526302
§Rubber, base	—	—	—	—	—	—	—	—

Part No.	53201B	53202B	53203B	53221A	†53271B	53290B	†53322A	53464A
Model	464	464	464	464	531	531-1	548	548
Finish	C.P.R.	C.P.R.	C.P.R.	C.P.R.	—	—	C.P.R.	C.P.R.
Replaced by (see footnote) . .	—	—	—	—	(53290)	—	(53464)	—
§Rim or door	573153	573164	573153	573164	—	—	574560	574560
§Screw, rim fixing	572072	573676	572072	573676	—	—	574558	574558
Washer, screw retaining	161385	161385	161385	161385	—	—	‡113061	‡113061
§Lens (stop tail)	—	—	—	—	573997	573997	161385	161385
§Lens (reverse)	571990	571990	571990	571990	574000	574000	574546	574546
§Gasket, rubber	571979	572087	571979	572087	573996	573996	574547	574547
Reflex and cover	—	—	—	—	574006	574006	574548	574548
Reflex	—	—	—	—	574749	574749	—	—
Cover, reflex	—	—	—	—	574002	574002	574552	574552
Body, rubber, reflex	—	—	—	—	573998	573998	‡574549	‡574549
Mounting plate	—	—	—	—	574003	574010	—	—
§Cover, bulb	571978	571978	571978	571978	—	—	—	—
§Bulb holder (stop tail)	—	—	—	—	572727	572727	—	—
§Bulb holder (reverse)	—	—	—	—	573285	573285	—	574559
§Interior, bulb holder (stop tail)	552101	552101	552101	552101	552101	552101	573828	573828
§Interior, bulb holder (reverse)	552101	552101	552103	552103	552103	552103	—	573832
§Bulb (stop tail)	380	380	380	380	380	380	380	380
§Bulb (reverse)	380	380	382	382	382	382	—	382
§Sleeve, terminal	188818	188818	188818	188818	—	—	188818	188818
Plate, bulb holder	—	—	—	—	—	—	¶574554	¶574554
Screw, bulb holder plate fixing .	—	—	—	—	—	—	132464	132464
§Nut, lamp fixing	—	—	—	—	166019	166019	—	—
Washer, lamp fixing	—	—	—	—	188330	188330	188412	188412
§Grommet, rubber	526302	—	526302	526302	—	—	—	—
§Rubber, base	—	—	—	—	573995	574011	574550	574550

Note. For replacement lamp spare parts, see appropriate column under part number † When ordering, quote part number shown in brackets ‡ Short
 § Recommended spares for stock ¶ Gasket, reverse lens ¶ Gasket, reverse bulb holder C.P.R. . . . Chromium plated rim

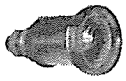

TAIL AND NUMBER PLATE LAMPS

DETAILED SPARE PARTS

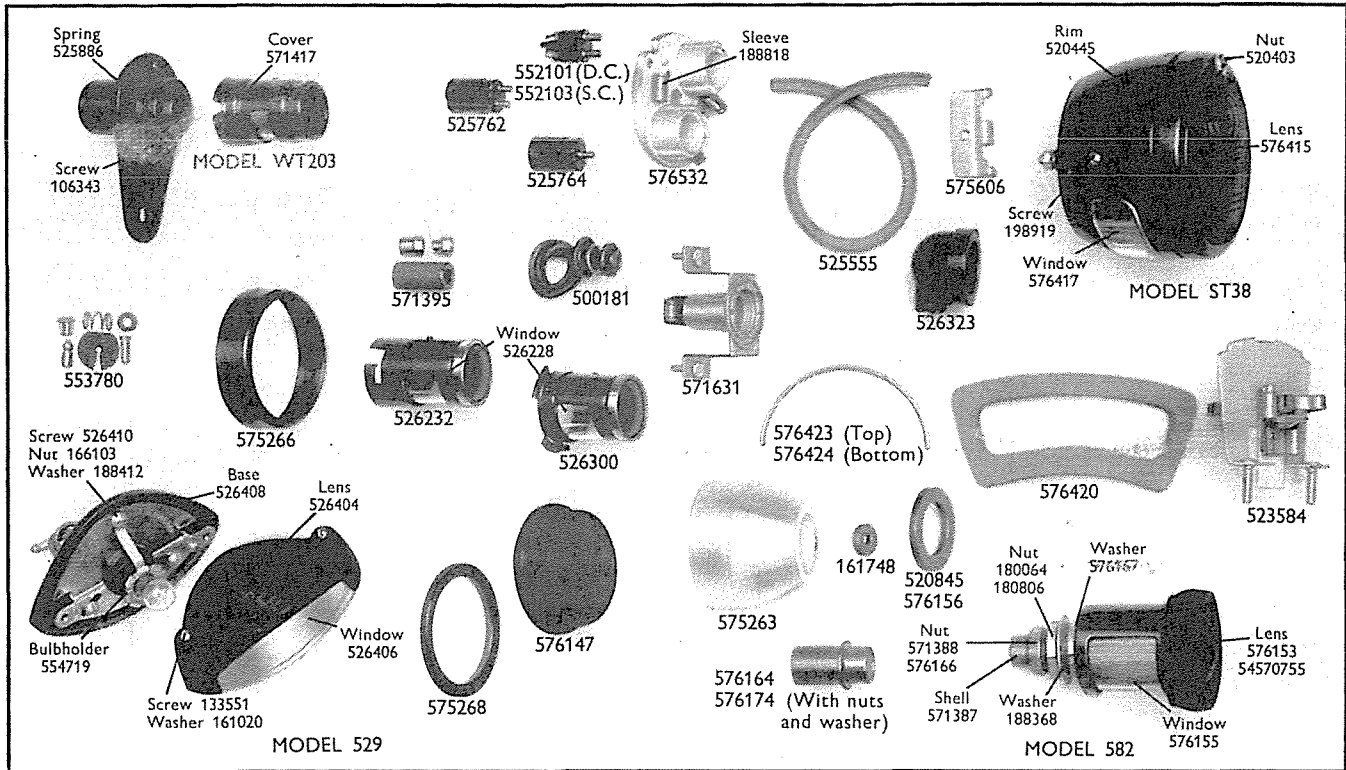

Part No.	†53007B	†A53007	53036A	53037A	†53041B	†53056A	†A53056A
Model	AT201L	AT201L	WT203	WT203	AT201L	MT211	MT211
Finish	Black	Black	Black	Black	Black	Black	Black
Replaced by (see footnote)	(53615)	(53614)	—	—	(53616)	(53256)	(A53256)
§Rim or door	‡576153	‡576153	‡571417	‡571417	‡576153	—	—
§Screw, rim or lens fixing	—	—	—	—	—	—	—
Washer, screw retaining	—	—	524215	—	—	—	—
§Gasket, rubber	520845	520845	—	—	520845	—	—
§Lens (stop tail)	576153	576153	—	—	576153	—	—
§Lens or window, number plate	—	—	—	—	—	526228	526228
Washer, shakeproof or locking	576167	576167	185012	—	576167	—	—
Nut, coupling	571388	571388	—	—	571388	—	—
Bracket, bulb holder spring clips	—	—	—	—	—	—	—
§Bulb, single contact	207	205	209	207	—	207	205
§Bulb, double contact	—	—	—	—	209	—	—
Body or base	—	—	—	—	—	—	—
Screw, body or platform fixing	—	—	106343	—	—	—	—
Cover	—	—	—	—	—	526232	526232
Washer, rubber, cable cover	161748	161748	—	—	805040	—	—
Shell, cable cover	571387	571387	—	—	571387	—	—
§Interior	525764	525764	552101	552103	525762	500181	500181
Shell, bulb holder	576174	576174	—	—	576174	—	—
§Connector, cable	—	—	—	—	—	571395	571395
§Springs, lens fixing	—	—	525886	—	—	—	—
§Gasket, window seating	—	—	—	—	—	—	—
Nut, fixing or locking	180064	180064	—	—	180064	—	—
§Partition	—	—	—	—	—	—	—
Sleeve, terminal	—	—	—	—	—	—	—
§Terminal, earth	—	—	—	—	—	—	—
§Bulb holder	—	—	—	—	—	—	—
Clip, spring, top	—	—	—	—	—	—	—
Clip, spring, bottom	—	—	—	—	—	—	—
Washer, fixing bolt	—	—	—	—	—	—	—

Note. For replacement lamp spare parts, see appropriate column under part number
 ‡ With lens § Recommended spares for stock

† When ordering, quote part number shown in brackets

continued

TAIL AND NUMBER PLATE LAMPS

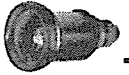

DETAILED SPARE PARTS

Part No.	†53133A	†53140B	†53241B	53256A	†53417A	†53436A
Model	AT201L	480	T38	529	AT202	AT202
Finish	Grey	Black, C.P.R.	Black	—	Black	Black
Replaced by (see footnote)	(53615)	(53256)	(53443)	—	(53616)	(53616)
§Rim or door	576153	—	520445	—	575266	575266
§Screw, rim or lens fixing	—	—	520403	133551	—	—
Washer, screw retaining	—	—	161385	161020	—	—
§Gasket, rubber	520845	—	525555	—	575268	575268
§Lens (stop tail)	576153	—	576415	526404	576147	576147
§Lens or window, number plate	—	526228	—	526406	575263	—
Washer, shakeproof or locking	576167	—	188330	188412	576167	576167
Nut, coupling	571388	—	—	—	571388	571388
Bracket, bulb holder	—	—	571631	—	—	—
§Bulb, single contact	207 **205	200	—	988	—	—
§Bulb, double contact	—	—	209	—	209	209
Body or base	—	—	—	526408	—	—
Screw, body or platform fixing	—	—	—	526410	—	—
Cover	—	526300	—	—	—	—
Washer, rubber, cable cover	161748	—	—	—	805040	805040
Shell, cable cover	571387	—	—	—	571387	571387
§Interior	525764	552103	—	553780	525762	525762
Shell, bulb holder	576174	—	—	—	576174	576174
§Grommet, rubber	—	526323	—	—	—	—
§Springs, lens fixing	—	—	—	—	—	—
§Gasket, window seating	—	—	—	—	575269	575269
Nut, fixing or locking	180064	—	¶166019	166103	180064	180064
§Partition	—	—	523584	—	—	—
Sleeve, terminal	—	—	188818	—	—	—
§Terminal, earth	—	—	523571	—	—	—
§Bulb holder	—	—	—	554719	—	—
Clip, spring, top	—	—	—	—	—	—
Clip, spring, bottom	—	—	—	—	—	—
Washer, fixing bolt	—	—	—	—	—	—

Part No.	53443A	†53513B	53614B	†53615B/D	53616B	53761B
Model	ST38E	582	582	582	582	582
Finish	Black	Black	Black	Black	Black	Black
Replaced by (see footnote)	—	(53615)	—	(53761)	—	—
§Rim or door	520445	—	—	—	—	—
§Screw, rim or lens fixing	§198919	—	—	—	—	—
Washer, screw retaining	—	—	—	—	—	—
§Gasket, rubber	525555	520845	—	—	—	—
§Lens (stop tail)	576415	54570755	54570755	54570755	54570755	54570755
§Lens or window, number plate	576417	576155	576155	576155	576155	576155
Washer, shakeproof or locking	188412	576167	576167	576167	576167	576167
Nut, coupling	—	571388	576166	576166	576166	576166
Bracket, bulb holder spring clips	575606	—	—	—	—	—
§Bulb, single contact	—	207	205	207	—	226
§Bulb, double contact	‡209 335	—	—	—	209	—
Body or base	—	—	—	—	—	—
Screw, body or platform fixing	132464	—	—	—	—	—
Cover	—	—	—	—	—	—
Washer, rubber, cable cover	—	161748	161748	161748	805040	161748
Shell, cable cover	—	571387	571387	571387	571387	571387
§Interior	—	525764	525764	525764	525762	525764
Shell, bulb holder	—	576174	576164	576164	576164	576164
§Connector, cable	—	—	—	—	—	—
§Springs, lens fixing	—	—	—	—	—	—
§Gasket, window seating	576420	576156	576156	576156	576156	576156
Nut, thick	‡520403	180064	180796	180796	180796	180796
Nut, thin	—	180064	180806	180806	180806	180806
§Partition	—	—	—	—	—	—
Sleeve, terminal	188818	—	—	—	—	—
§Terminal, earth	—	—	—	—	—	—
§Bulb holder	576532	—	—	—	—	—
Clip, spring, top	576423	—	—	—	—	—
Clip, spring, bottom	576424	—	—	—	—	—
Washer, fixing bolt	—	—	188368	188368	188368	188368

Note. For replacement lamp spare parts, see appropriate column under part number † When ordering, quote part number shown in brackets
 ‡ Number plate illumination § Recommended spares for stock ¶ Nut, rim fixing * Partition and lamp fixing § Bracket fixing
 ** 6 volt C.P.R. . . . Chromium plated rim

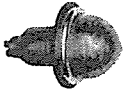

TAIL LAMPS

DETAILED SPARE PARTS

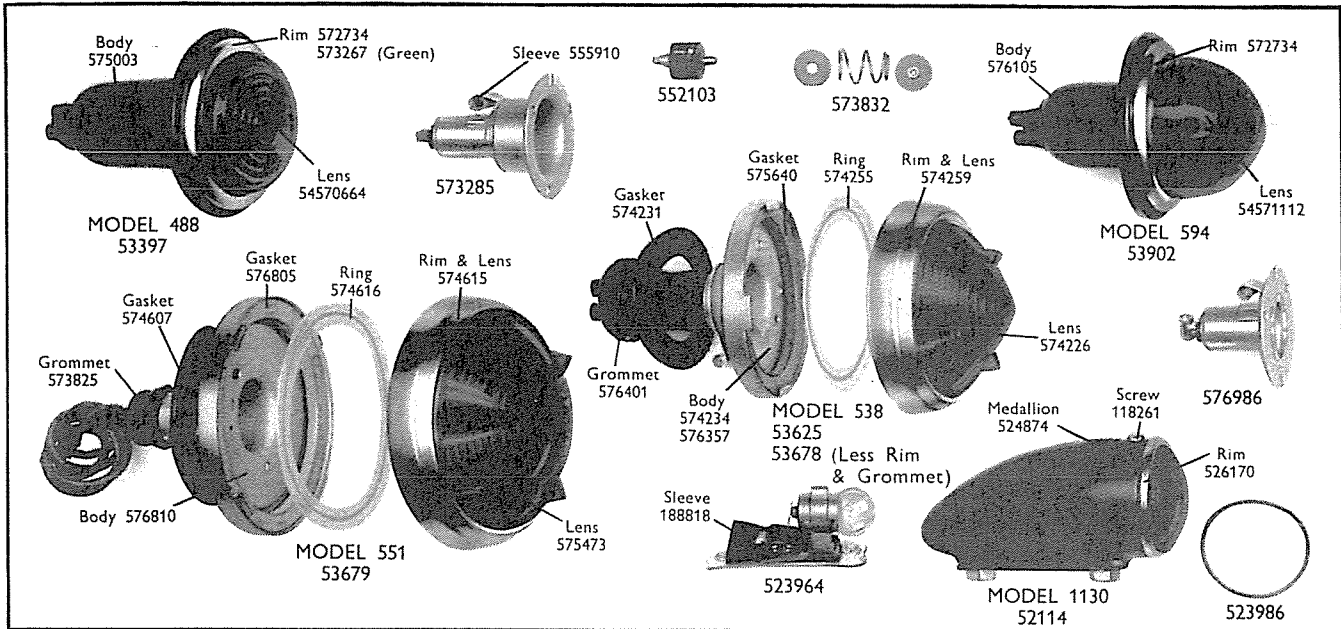

Part No.	52114A 1130 Black, C.P.R.	*53019A L-WD-T2A Primer	†53250E 488 Green rim (53397)	53315E/F 488 C.P.R.	53397D/E 488 C.P.R.
§Rim or door	526170	—	573267	572734	572734
§Screw, rim fixing	118261	—	—	—	—
§Lens	—	—	54570664	54570664	54570664
§Gasket, lens seating	523986	—	—	—	—
§Ring, sliding	—	—	—	—	—
§Body, rubber	—	—	575003	575003	575003
Body or backplate	—	—	—	—	—
§Bulb holder	523964	—	573285	573285	573285
§ Interior, bulb holder	—	552103	552103	552103	552103
§Bulb, single contact	207	207	207	221	207
§Sleeve, terminal	188818	—	555910	555910	555910
§Gasket, body seating	—	—	—	—	—
§Grommet, cable	—	—	—	—	—
§Medallion, body	524874	—	—	—	—

Part No.	†53533A/B 538 C.P.R. (53625)	53625A 538 C.P.R.	53678A 538	53679A 551 C.P.R.	53902A/B 594 C.P.R.
§Rim or door	‡574259	‡574259	—	‡574615	572734
§Screw, rim fixing	—	—	—	—	—
§Lens	574226	574226	574226	575473	54571112
§Gasket, lens seating	575640	575640	575640	576805	—
§Ring, sliding	574255	574255	574255	574616	—
§Body, rubber	—	—	—	—	576105
Body or backplate	574234	576357	574234	576810	—
§Bulb holder	—	—	—	—	576986
§ Interior, bulb holder	573832	573832	573832	573832	552103
§Bulb, single contact	207	207	207	382	207
§Sleeve, terminal	—	—	—	555910	555910
§Gasket, body seating	574231	574231	574231	574607	—
§Grommet, cable	—	576401	—	573825	—
§Medallion, body	—	—	—	—	—

Note. For replacement lamp spare parts, see appropriate column under part number * See Supersession Chart
 † When ordering, quote part number shown in brackets ‡ Lens and rim § Recommended spares for stock

C.P.R. . . . Chromium plated rim

FLASHER INDICATOR SETS

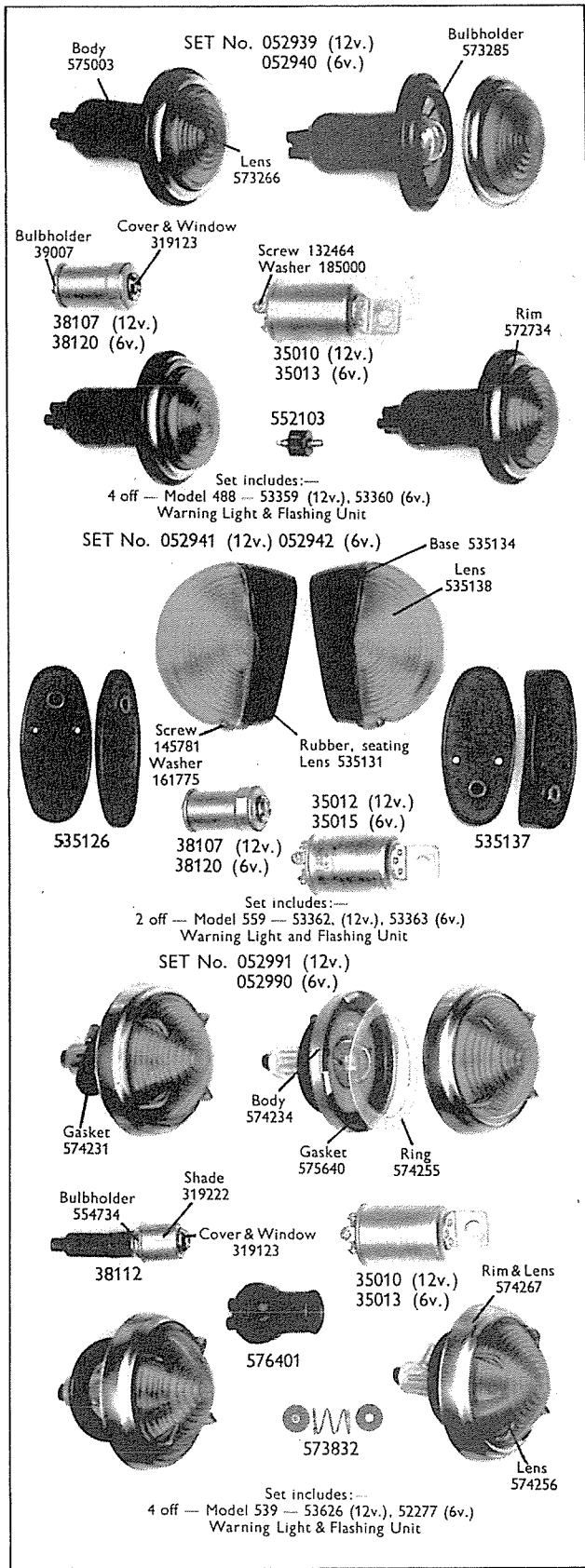
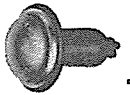

Model 488	12 VOLT	6 VOLT
	Set No. 052939	Set No. 052940
Description	Part No.	Part No.
§ Lamp, Model 488 (4 off)	53359	53360
§ Rim or door	572734	572734
§ Lens	573266	573266
§ Body	575003	575003
§ Bulb holder	573285	573285
§ Interior, bulb holder	552103	552103
§ Bulb	382	317
§ Sleeve, terminal	555910	555910
§ Flasher Unit, Model FL5 (1 off)	35010	35013
§ Screw, terminal	132464	132464
§ Washer, terminal screw	185000	185000
§ Warning light, Model WL12 (1 off)	38107	38120
§ Cover and window	319123	319123
§ Bulb holder	39007	39007
§ Bulb	987	990

Model 559	12 VOLT	6 VOLT
	Set No. 052941	Set No. 052942
Description	Part No.	Part No.
§ Lamp, Model 559 (2 off)	53362	53363
§ Lens	535138	535138
§ Screw, lens fixing	145781	145781
§ Washer, screw retaining	161775	161775
§ Rubber, lens seating	535131	535131
§ Rubber, base seating	535126	535126
§ Base	535134	535134
§ Sleeve, terminal	188818	188818
§ Bulb	382	317
§ Flasher Unit, Model FL5 (1 off)	35012	35015
§ Screw, terminal	132464	132464
§ Washer, terminal screw	185000	185000
§ Warning Light, Model WL12 (1 off)	38107	38120
§ Cover and window	319123	319123
§ Bulb holder	39007	39007
§ Bulb	987	990
§ Pad, lamp mounting (2 off)	535137	535137

Model 539	12 VOLT	6 VOLT
	Set No. 052991	Set No. 052990
Description	Part No.	Part No.
§ Lamp, Model 539 (4 off)	52278 (53626)	52277
§ Lens and rim	574267	574267
§ Lens	574256	574256
§ Gasket, lens seating	575640	575640
§ Ring, sliding	574255	574255
§ Body, with bulb holder	574234	574234
§ Interior, bulb holder	573832	573832
§ Bulb	382	317
§ Gasket, body seating	574231	574231
§ Grommet	—	576401
§ Flasher Unit, Model FL5 (1 off)	35010	35013
§ Screw, terminal	132464	132464
§ Washer, terminal screw	185000	185000
§ Warning Light, Model WL13 (1 off)	38112	38120
§ Shade	319222	—
§ Cover and window	319123	319123
§ Bulb	987	990
§ Bulb holder	554734	39007

† When ordering lamp only, quote part number shown in brackets

§ Recommended spares for stock

‡ Model WL12 (1 off)

continued

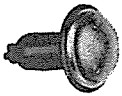

FLASHER INDICATOR SETS

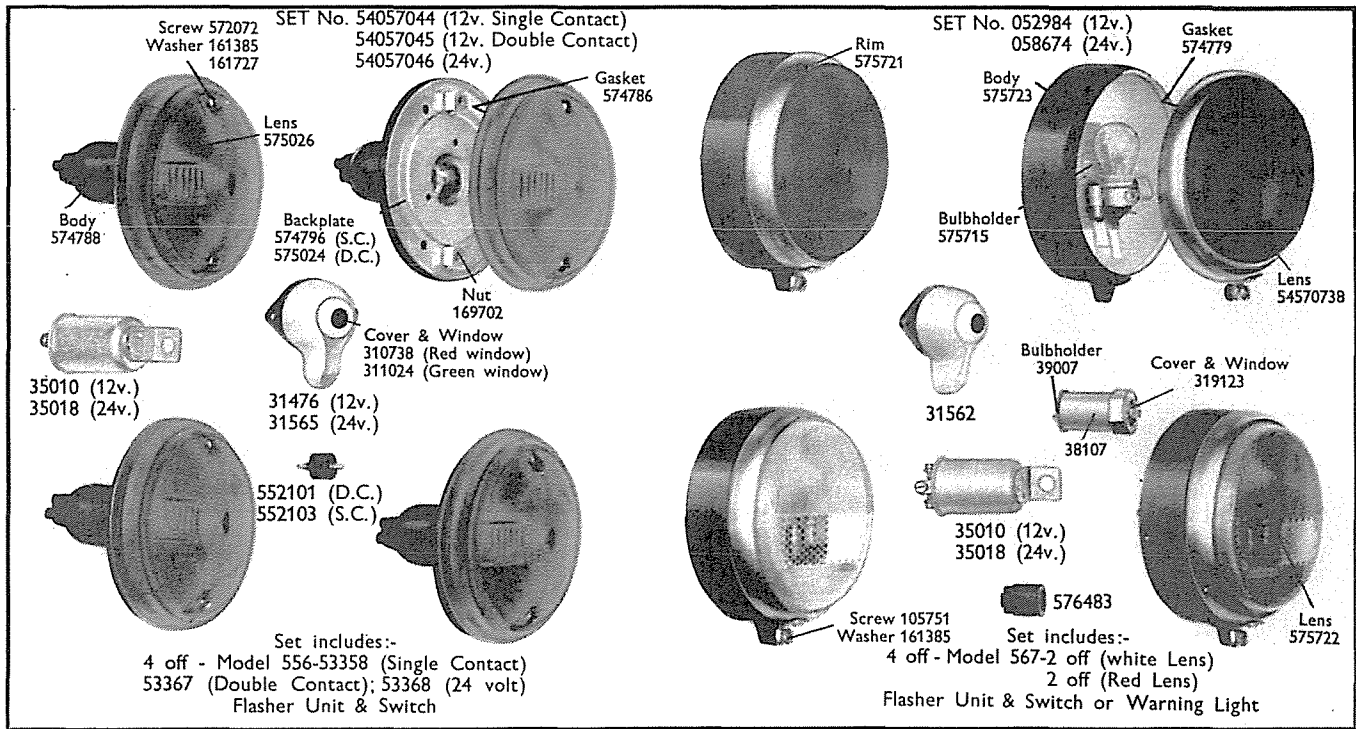

Model 556	12 VOLT	12 VOLT	24 VOLT
	(Earth return)	(Insulated return)	(Insulated return)
	Set No.	Set No.	Set No.
	54057044	54057045	54057046
Description	Part No.	Part No.	Part No.
§Lamp, Model 556 (4 off)	53358	53367	53368
§ Lens	575026	575026	575026
§ Screw, lens fixing	572072	572072	572072
Washer, screw retaining	161385	161385	161385
Washer, leatheroid	161727	161727	161727
§ Gasket, lens seating	574786	574786	574786
§ Body, rubber	574788	574788	574788
Backplate, with bulb holder	574796	575024	575024
§ Interior, bulb holder	552103	552101	552101
§ Bulb	382	335	333
§ Sleeve, terminal	555910	555910	555910
Nut, lens fixing screw	169702	169702	169702
§Flasher Unit, Model FL5 (1 off)	35010	35010	35018
§ Screw, terminal	132464	132464	132464
§ Washer, terminal screw	185000	185000	185000
§Switch, Model SD84 (1 off)	31476	31476	31565
Cover and window	310738	310738	311024
§ Bulb	987	987	650
§ Screw, terminal	120560	120560	120560

Model 567	12 VOLT	24 VOLT
	Set No.	Set No.
	052984	058674
Description	Part No.	Part No.
§Lamp, Model 567 (2 off, white lens)	52270	52354
§ Rim or door	575721	575721
§ Screw, rim fixing	105751	105751
Washer, retaining screw	161385	161385
§ Gasket, lens seating	574779	574779
§ Lens	575722	575722
§ Bulb holder	575715	575715
§ Bulb	380	334
§ Sleeve, terminal	188818	188818
§ Grommet, cable	576483	576483
Nut, lamp fixing	177014	177014
Washer, shakeproof, fixing nut	188470	188470
Body	575723	575723
§Lamp, Model 567 (2 off, red lens)	53427	53605
§ Rim or door	575721	575721
§ Screw, rim fixing	105751	105751
Washer, retaining screw	161385	161385
§ Lens	54570738	54570738
§ Gasket, lens seating	574779	574779
§ Bulb holder	575715	575715
Rivet, bracket securing	188714	188714
§ Bulb	380	334
§ Sleeve, terminal	555910	555910
§ Grommet, cable	576483	576483
Nut, lamp fixing	177074	177074
Washer, shakeproof, fixing nut	188329	188329
Body	575723	575723
§Flasher Unit, Model FL5 (1 off)	35010	35018
§ Screw, terminal	132464	132464
§ Washer, terminal screw	185000	185000
§Warning Light, Model WL12 (1 off)	38107	‡31562
Cover and window	319123	310738
Connector, bulb	—	311037
§ Bulb holder	39007	—
§ Screw, terminal	—	120560
§ Bulb	987	650

‡ Switch SD84

REFLEX REFLECTORS



For detailed spare parts, see pages K56-K57

Part No.	Replaced by	Model	Reflex Diameter (inches)	Reflex Colour	Mount	Fixing	Rim	Reflector, Reflex	Holder	Screw, Fixing	Washer, Plain	Washer, Spring or Shakeproof	Nut, Fixing
57030E	—	RER2	1½	Red	Silver grey rubber	Single screw	—	574749	573649	198877	135084	—	—
57031D	—	RER2	1½	Red	Black rubber	Single screw	—	574749	573764	198877	135084	—	—
57032A/B	—	RER3	1½ × 1¼ (3 off)	Red	Silver grey rubber	Two hole	—	608610	573766	—	—	—	—
57033E	—	RER4	3	Red	Silver grey rubber	Three hole	—	575863	—	—	—	—	—
57035D	57052	RER5	1½	Red	C.P.R., black rubber	Single screw	573801	574749	573800	198877	135120	—	—
57037D	—	RER4	3	Amber	Silver grey rubber	Three hole	—	573874	—	—	—	—	—
57039D	—	RER2	1½	Amber	Silver grey rubber	Single screw	—	573796	573649	198877	135084	—	—
57040D	—	RER2	1½	Clear	Silver grey rubber	Single screw	—	573797	573649	198877	135084	—	—
57043B	—	RER3	1½ × 1¼ (3 off)	Amber	Silver grey rubber	Two hole	—	573799	573766	—	—	—	—
57044A/B	—	RER3	1½ × 1¼ (3 off)	Red	Black rubber	Two hole	—	608610	573766	—	—	—	—
57045A	—	RER3	1½ × 1¼ (3 off)	Amber	Black rubber	Two hole	—	573799	573766	—	—	—	—
57047D	—	RER6	1½	Red	Black rubber	Single screw	—	574749	573868	198877	—	—	—
57048B	57131	RER5	1½	Red	C.P.R., black rubber	Grommet	573801	574749	573871	—	—	—	—
57050B	—	RER7	1½	Red	C.P.R., black rubber	Grommet	573877	574749	—	—	—	—	—
57051B	—	RER7	1½	Red	Black rubber	Grommet	—	574749	—	—	—	—	—
57052B	57124	RER5	1½	Red	C.P.R., black rubber	Single screw	573801	574749	573800	198865	135120	—	—
57053B	—	RER8	3	Red	White (metal body)	Three hole	—	—	—	—	—	—	—
57054A	—	RER8	3	Amber	White (metal body)	Three hole	—	—	—	—	—	—	—
57055B	—	RER9	3	Red	White (metal body)	Right angle bracket	—	—	—	—	—	—	—
57056A	—	RER9	3	Amber	White (metal body)	Right angle bracket	—	—	—	—	—	—	—
57061D	—	RER6	1½	Clear	Silver grey rubber	Single screw	—	573797	—	198877	—	—	—
57063B	57126	RER5	1½	Amber	C.P.R., black rubber	Single screw	573801	573796	573800	198877	135120	—	—
57065B	—	RER2	1½	Clear	Black rubber	Single screw	—	573797	573764	198877	135084	—	—
57066B	—	RER12	¾ (9 off)	Red	White triangular metal plate	—	—	—	—	—	—	—	—
57067B	—	RER5	1½	Clear	C.P.R., black rubber	Grommet	573801	573797	—	—	—	—	—
57069A	—	RER8	3	Clear	White (metal body)	Three hole	—	—	—	—	—	—	—
57070B	57129	RER5	1½	Red	C.P.R., black rubber	Single screw	573801	574749	573800	100003	135120	188330	166043
57072B	—	RER7	1½	Red	C.P.R., black rubber	Grommet	573877	574749	575518	‡574002	—	—	—
57073B/D	—	RER13	3	Red	Metal case	Stud	—	573866	—	—	—	188329	172580
57074A	—	RER14	2½	Red	C.P.R., black rubber	Single screw	572734	575189	575182	—	—	—	—
57075B	57133	RER5	1½	Red	C.P.R., black rubber	Less screw	573801	574749	575185	—	135120	—	—
57077B	57133	RER5	1½	Red	C.P.R., black rubber	Single screw	573801	574749	575185	198865	135120	—	—
57078A	57128	RER5	1½	Red	C.P.R., black rubber	Single screw	573801	574749	573800	198894	135120	—	—
57079A	—	RER14	2½	Red	Black rubber	Single screw	—	575189	—	—	—	—	—
57080A	—	RER16	1½	Red	C.P.R., black rubber	—	575481	574749	575480	—	—	188330	175300
57082A	—	RER14	2½	Red	C.P.R., black rubber	Single screw	572734	575189	575194	—	—	—	—
57083A	—	RER14	2½	Red	C.P.R., black rubber	Two stud	572734	575189	575194	—	—	188330	166043

‡ Cover, reflex C.P.R. ... Chromium plated rim

REFLEX REFLECTORS

REFLEX REFLECTORS

Part No.	Replaced by	Model	Reflex Diameter (inches)	Reflex Colour	Mount	Fixing	Rim	Reflector, Reflex	Holder	Screw, Fixing	Washer, Plain	Washer, Spring or Shakeproof	Nut, Fixing
57084A	57052	RER5	1½	Red	C.P.R., black rubber ..	Less screw ..	573801	574749	573800	—	135120	—	—
57085B	—	RER17	1½ × 1¼	Red	C.P.R., light grey rubber	Single screw ..	575352	608610	575350	198865	135084	—	—
57086A	—	RER18	1½	Red	C.P.R., black rubber ..	Single screw ..	573877	574749	575489	198877	135120	‡574002	—
57087B	—	RER13	3	Red	C.P.R.	Single bolt ..	—	573866	—	—	—	188329	172580
57090B	—	RER2	1½	Red	Grey rubber	Single screw ..	—	574749	575513	126580	131023	185220	166043
57091A	—	RER2	1½	Red	Black rubber	Single screw ..	—	574749	575512	—	135084	—	—
57093A	—	RER20	1½	Red	C.P.R., rolled over reflex	Single screw ..	—	—	—	—	—	185106	166043
57095A	57122	RER5/T	1½	Red	C.P.R., black rubber ..	Single screw ..	573801	574749	575884	198865	135120	—	—
57097A	—	RER21	2 ½	French	C.P.R., rolled over reflex	Single screw ..	—	—	—	—	—	185040	166019
57098A	—	RER22	2 ½ × 1½	Red	C.P.R.	Two hole ..	575908	575883	—	—	—	—	—
57109A	—	2DP	4	Amber	Decorative hub cap ..	Single bolt ..	—	—	—	—	131023	—	169654
57111A	—	RER24	—	Red	Metal base	Two rivets ..	—	—	—	—	—	—	—
57113A	—	RER26	2 ½ × 1½	Red	C.P. holder	Two stud ..	—	575883	54570514	54120003	‡54570516	‡54570517	—
57115A	—	RER27	2 ½	Red	C.P.R.	Two stud ..	—	54570658	54570657	186134	§54570662	—	—
57116A	—	RER25	1½	Red	Black rubber	Single screw ..	54570241	575878	54570242	198877	135120	—	—
57118A	—	RER29	2 ¼	Red	C.P.R.	Single screw ..	—	—	—	—	—	188330	166043
57120A	—	RER25	1½	Red	C.P.R., black rubber ..	Less fixing screw	54570241	575878	54571068	—	135120	—	—
57121A	—	RER25	1½	Red	C.P.R., black rubber ..	Less fixing screw	54570241	575878	54571066	—	135120	—	—
57122A	—	RER25	1½	Red	C.P.R., black rubber ..	Single screw ..	54570241	575878	54571109	198865	135120	—	—
57123A	—	RER30	1½	Red	C.P.R.	Less fixing screw	574247	54571128	**574255	§575640	††54571132	—	‡‡54571148
57123B	—	RER30	1½	Red	C.P.R.	Two stud ..	574247	54571128	**574255	§575640	††54571473	188483	166036
57124A	—	RER25	1½	Red	C.P.R., black rubber ..	Single screw ..	54570241	575878	54570242	198865	135120	—	—
57125A	—	RER25	1½	Red	C.P.R., black rubber ..	Grommet ..	54570241	575878	54571174	—	—	—	—
57126A	—	RER25	1½	Amber	C.P.R., black rubber ..	Single screw ..	54570241	54570264	54570242	198877	135120	—	—
57127A	—	RER25	1½	Clear	C.P.R., black rubber ..	Single screw ..	54570241	54571276	54570242	198877	135120	—	—
57128A	—	RER25	1½	Red	C.P.R., black rubber ..	Single screw ..	54570241	575878	54570242	198894	135120	—	—
57129A	—	RER25	1½	Red	C.P.R., black rubber ..	Single screw ..	54570241	575878	54570242	100003	135120	188330	166043
57130A	—	RER25	1½	Red	C.P.R., black rubber ..	Single screw ..	54571283	575878	54570242	100003	135120	188330	166043
57131A	—	RER25	1½	Red	C.P.R., black rubber ..	Grommet ..	54570241	575878	54571096	—	—	—	—
57132A	—	RER25	1½	Clear	C.P.R., black rubber ..	Grommet ..	54570241	54571276	54571174	—	—	—	—
57133A	—	RER25	1½	Red	C.P.R., black rubber ..	Single screw ..	54570241	575878	54571068	198865	135120	—	—
57135A	—	3DP	2	Amber	Decorative hub cap ..	Single bolt ..	—	—	—	—	131023	—	169654
57136A	—	RER27	2 ¼	Red	C.P.R.	Two stud ..	—	54570658	54570657	186134	§54570662	—	—
65423	—	48-3	2 ¾	Red	C.P.R.	Three screw ..	572734	§§54570664	—	—	—	—	—
65424	—	41T	1 ¾	Red	C.P.R., rolled over reflex	Two stud ..	—	—	—	—	—	185040	166019
65441	65424	41T	1 ¾	Red	C.P.R., rolled over reflex	Two stud ..	—	—	—	—	—	185040	166019
575883	—	RER22	2 ½ × 1½	Red	Reflex and seal only ..	—	—	—	—	—	—	—	—
576271	—	RER14	2 ¾	Red	Reflex and filler cap ..	—	—	—	—	—	—	—	—

‡ Cover, reflex †† Plate, fixing ‡ Base, rubber § Gasket ** Ring, sliding ††† Body ††† Gasket, body seating §§ With reflector §§ Lens C.P. .. Chromium plated
C.P.R. .. Chromium plated rim



REAR LAMP LENSES

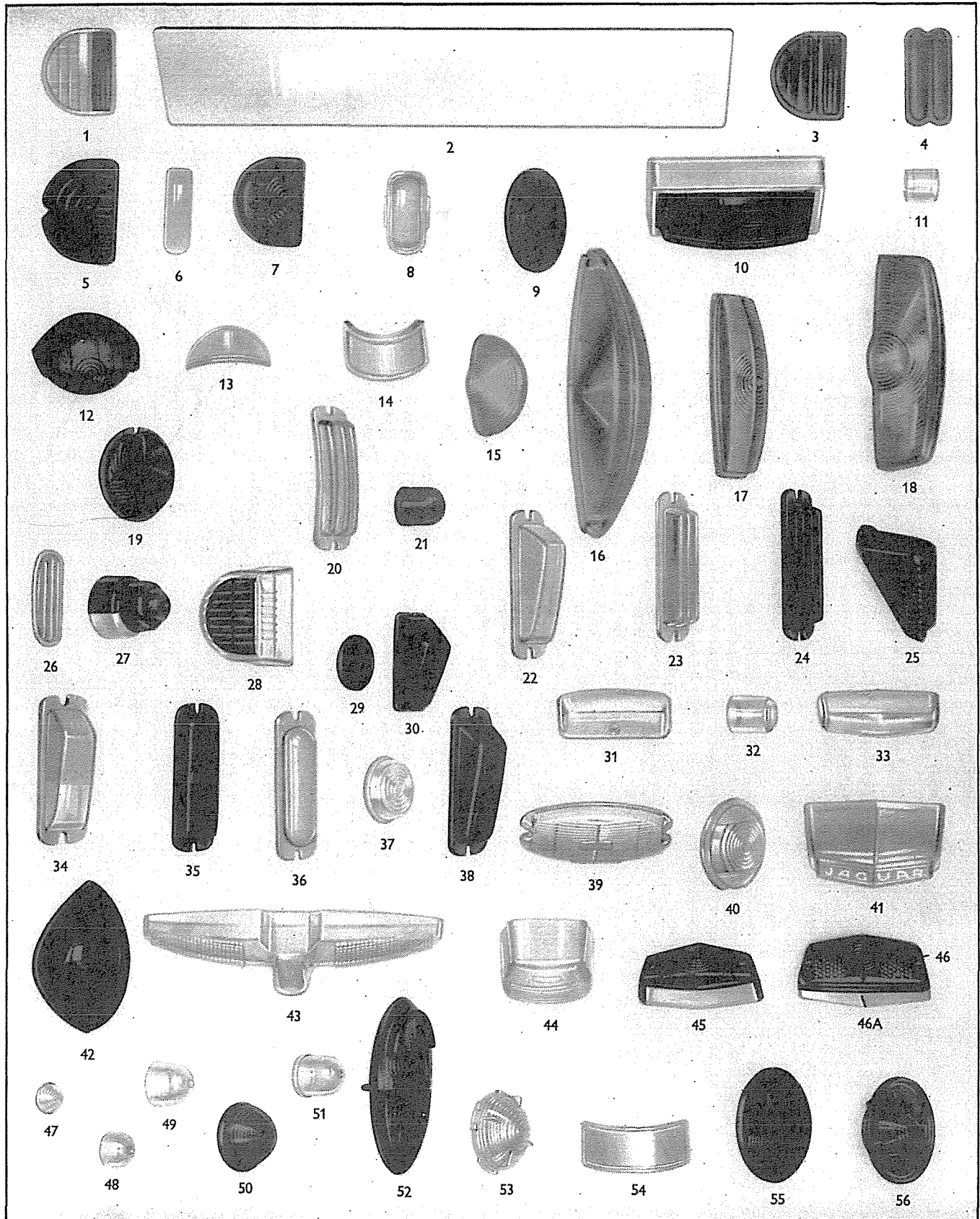

REAR LAMP LENSES



LENS CHART

Part No.	Type	Illustration Reference	Fitted to	Description
521578	Glass	1	TR50, 51 and 288-3 ..	'D' shaped; half clear and half ruby; fluted.
521654	Glass	2	288-3	Rectangular shaped; clear.
522264	Glass	3	ST50, 51 and 280-1 ..	'D' shaped; ruby; fluted.
523255	Glass	4	ST52	Ruby; stippled.
523307	Glass	5	288-3	'D' shaped; ruby; stippled; 'U' shaped flutes.
523308	Glass	5	288-3	'D' shaped; half ruby and half clear; otherwise as 523307.
523764	Glass	6	ST50	Clear.
524823	Glass	7	ST51	'D' shaped; red; stippled.
524843	Lens	8	ST51	Clear.
524910	Glass	9	DC43	Red; circular; stippled.
525186	Glass	10	ST53	Special ruby lens for Hillman 'Minx' 1945.
526228	Lens	11	MT211	Clear window.
526404	Lens	12	529	Ruby; grooved; single centre cone.
526406	Lens	13	529	Clear; semi-circular; fluted.
526437	Lens	14	518-1	Clear window.
535138	Lens	15	559	Amber; 'D' shaped; dished.
535242	Lens	16	568	Amber; 'D' shaped; dished.
535343	Lens	17	585	Amber; rectangular shaped.
535830	Lens	18	617	Amber; blister type; lightly stippled.
571643	Glass	19	ST38	Red; circular; fluted.
571717	Glass	5	ST54	Red; 'D' shaped.
571974	Glass	20	464	Clear; ridged; radiused to suit wing contour; lightly shot-blast.
571978	Glass	21	464	Ruby; domed.
571989	Glass	22	464	Clear; dished; lightly shot-blast inside.
571990	Glass	23	464	Clear; ridged; shot-blast inside.
571997	Glass	24	464	Red; ridged.
572089	Glass	23	464	Amber; otherwise as 571990.
572239	Lens	25	471	Ruby; dished; single cone.
572278	Glass	2	296	Rectangular shaped; clear.
572328	Glass	26	469	Clear; moulded; sand-blast inside.
572403	Glass	27	472	Domed; ruby and clear.
572441	Glass	28	476	'D' shaped; dished; half ruby and half clear; fluted.
572442	Glass	28	476	'D' shaped; dished; ruby; fluted.
572507	Glass	29	482	Ruby; circular; lightly stippled; centre screw fixing.
572578	Glass	30	484	Ruby; dished; single cone.
572596	Glass	31	467-2	Clear glass; window cover.
572625	Glass	33	485	Clear; special for Humber 'Hawk'.
572653	Glass	34	464	Half clear and half lightly shot-blast; dished.
572672	Glass	35	464	Ruby; ribbed; similar to 572673, but two-cone.
572673	Glass	35	464	Ruby; ribbed; single centre cone.
572674	Glass	36	464	Clear; satin etched inside; special for Austin A90.
572715	Glass	37	488	Clear; circular; lightly stippled.
572876	Glass	38	464	Ruby; dished; two centre cones.
572888	Glass	38	464	Ruby; dished; single centre cone.
573001	Glass	31	467-2	Clear; satin etched inside.
573055	Glass	32	No. 1, Mk. I ..	Clear; domed.
573266	Glass	37	488	Amber; circular; lightly stippled.
573283	Glass	39	494	Clear; horizontal fluted; Lucas medallion.
573403	Glass	40	511	Clear; circular; fluted.
573469	Glass	27	472	Clear cover.
573474	Glass	27	472	Clear cover; lightly shot-blast; otherwise as 573469.
573513	Glass	41	512	Clear; dished; marked 'Jaguar'.
573543	Glass	42	515	Ruby; domed; special for Vauxhall.
573615	Glass	47	516	Clear; domed.
573704	Glass	43	528	Clear; dished.
573723	Glass	43	528	Yellow; dished; otherwise as 573704.
573747	Glass	44	527	Clear; dished.
573819	Lens	45	525	Red; dished; sealed clear window insert.
573839	Lens	46	564	Red; dished; single centre cone.
573888	Glass	26	469	Clear; marked 'Wolseley'.
573900	Glass	26	469	Red; otherwise as 572328.
573907	Glass	26	469	Clear; 'Wolseley' in gold.
573915	Glass	48	524	Clear; domed.
573925	Glass	49	524	Clear; domed.
573997	Glass	50	531	Ruby; deep domed; internal grooves.
574000	Glass	50	531	Clear; otherwise as 573997.
574046	Glass	51	532	Clear; domed; flanges flat on two sides.
574069	Lens	52	523	Ruby; oval shaped; twin cones.
574105	Lens	54	533	Clear window.
574108	Glass	55	533	Ruby; circular fluted; marked 'Lucas'.
574226	Lens	53	538	Ruby; circular; domed.
574243	Lens	53	539	Clear; circular; domed.
574245	Lens	56	—	Aluminised; decorative dummy lens.
574256	Lens	53	538	Amber; circular; domed.
574260	Lens	56	—	Red; decorative dummy lens.

continued



REAR LAMP LENSES

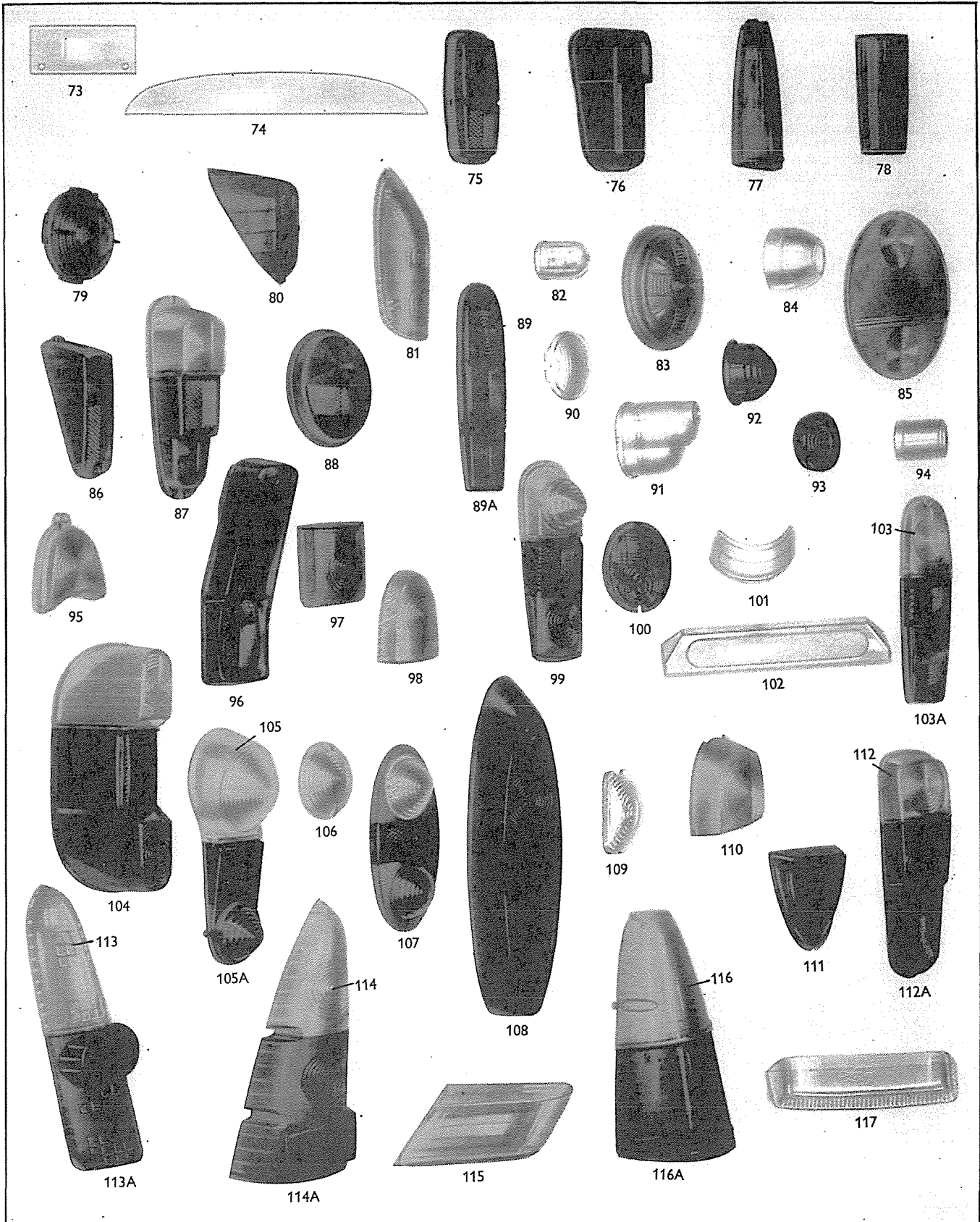

REAR LAMP LENSES

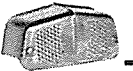

LENS CHART—*continued*

Part No.	Type	Illustration Reference	Fitted to	Description
574310	Lens	73	543	Clear.
574311	Lens	74	543	Clear.
574323	Lens	75	542	Ruby; circular flutes at top, reflex at bottom.
574460	Lens	76	546	Ruby; two-cone; top half reflex (right hand).
574461	Lens	76	546	Left hand; otherwise as 574460.
574546	Lens	77	548	Red; domed; oblong shaped.
574547	Lens	78	548	Clear; domed; oblong shaped; otherwise as 54571072.
574609	Lens	79	551	Red; circular, with reflex.
574635	Lens	80	549	Ruby; dished; incorporating reflex.
574720	Lens	81	553	Amber; oval; domed.
574804	Glass	82	554	Clear; domed.
574945	Lens	81	553	Deep amber; otherwise as 574720.
574946	Lens	81	553	Red; otherwise as 574720.
575026	Lens	83	556	Amber; circular.
575200	Lens	46A	564	Clear; shaped to combine with 573839; for illustration, see page K58.
575263	Lens	84	AT202.. .. .	Clear; domed.
575335	Glass	41	512	Yellow; dished; marked 'Jaguar'; for illustration, see page K58.
575364	Lens	85	570	Amber; circular.
575449	Lens	86	571	Red; cheesedish type; with reflex.
575473	Lens	79	583	Red; circular, with reflex.
575581	Lens	87	558	Red; amber section at top.
575584	Lens	87	558	All red; otherwise as 575581.
575722	Lens	88	567	Clear; circular, with reflex.
575760	Lens	89A	572	Clear.
575763	Lens	89A	572	Red.
575910	Glass	90	574	Clear; circular; grooved; heavy stipple.
575911	Lens	91	574	Clear; domed.
575925	Glass	90	574	Yellow; otherwise as 575910.
576108	Glass	92	594	Amber; circular; deep domed.
576109	Glass	92	594	Red; circular; deep domed.
576153	Lens	93	582	Red; circular; domed.
576155	Lens	94	582	Clear window.
576184	Lens	95	583	Amber; triangular shaped.
576255	Lens	96	601	Red; incorporating reflex in lower half.
576267	Lens	97	587	Red; used with flasher lens 576268.
576268	Lens	98	587	Amber; used with stop tail lens 576267.
576278	Lens	98	587	Red; otherwise as 576268.
576337	Lens	99	596	Red; incorporating reflex in centre and amber flasher at top.
576338	Lens	99	596	Red; incorporating reflex in centre and red flasher at top.
576415	Lens	100	ST38 and DC43	Red; circular.
576417	Lens	101	ST38	Clear window.
576463	Lens	102	599	Clear; dished.
576586	Lens	103	572	Amber; used with stop tail lens 576588.
576588	Lens	103A	572	Red; used with flasher lens 576586.
576900	Glass	26	469	Yellow; otherwise as 572328; for illustration, see page K58.
576933	Lens	104	589	Amber and red; right hand.
576934	Lens	104	589	Amber and red; left hand.
576955	Lens	105	593	Amber; domed; used with 54570085.
576956	Lens	105	593	Red; domed; used with 54570085.
576983	Lens	92	594	Clear; circular; deep domed.
577066	Lens	106	604	Amber; circular; domed.
577070	Lens	106	604	Red; otherwise as 577066.
577153	Lens	107	600	Red, with amber lens at top, reflex in centre.
577156	Lens	107	600	All red; otherwise as 577153.
577259	Lens	108	606	Red; oval shaped; incorporating reflex.
577443	Glass	109	601	Clear; dished; circular fluted; used with 577449.
577449	Lens	96	601	Red outer lens; used with 577443.
577728	Lens	110	620	Amber; dished; circular flutes.
577729	Lens	111	620	Red; dished; circular flutes.
577854	Lens	112	631	Amber; dished; circular flutes; used with 577857.
577857	Lens	112A	631	Red; dished; circular flutes.
54570076	Lens	113	616	Amber; cone shaped; used with 54570081.
54570081	Lens	113A	616	Red; incorporating reflex; used with 54570076.
54570082	Lens	113	616	Red; otherwise as 54570076.
54570085	Lens	105A	593	Red lens, with reflex; used with 576955.
54570099	Lens	114	621	Amber; cone shaped; used with 54570150.
54570118	Lens	85	570	Red; otherwise as 575364.
54570150	Lens	114A	621	Red, with seal and reflex; used with 54570099.
54570156	Lens	115	607	Amber outer lens with clear inner lens; right hand.
54570157	Lens	115	607	Amber; as 54570156, but left hand.
54570161	Lens	115	607	Amber; as 54570156, but complete with clip.
54570162	Lens	115	607	Amber; as 54570157, but complete with clip.
54570179	Lens	116	640	Amber; cone shaped; used with 54570181.
54570181	Lens	116A	640	Red; used with 54570179.
54570185	Glass	117	623	Clear; dish shaped.

continued



REAR LAMP LENSES

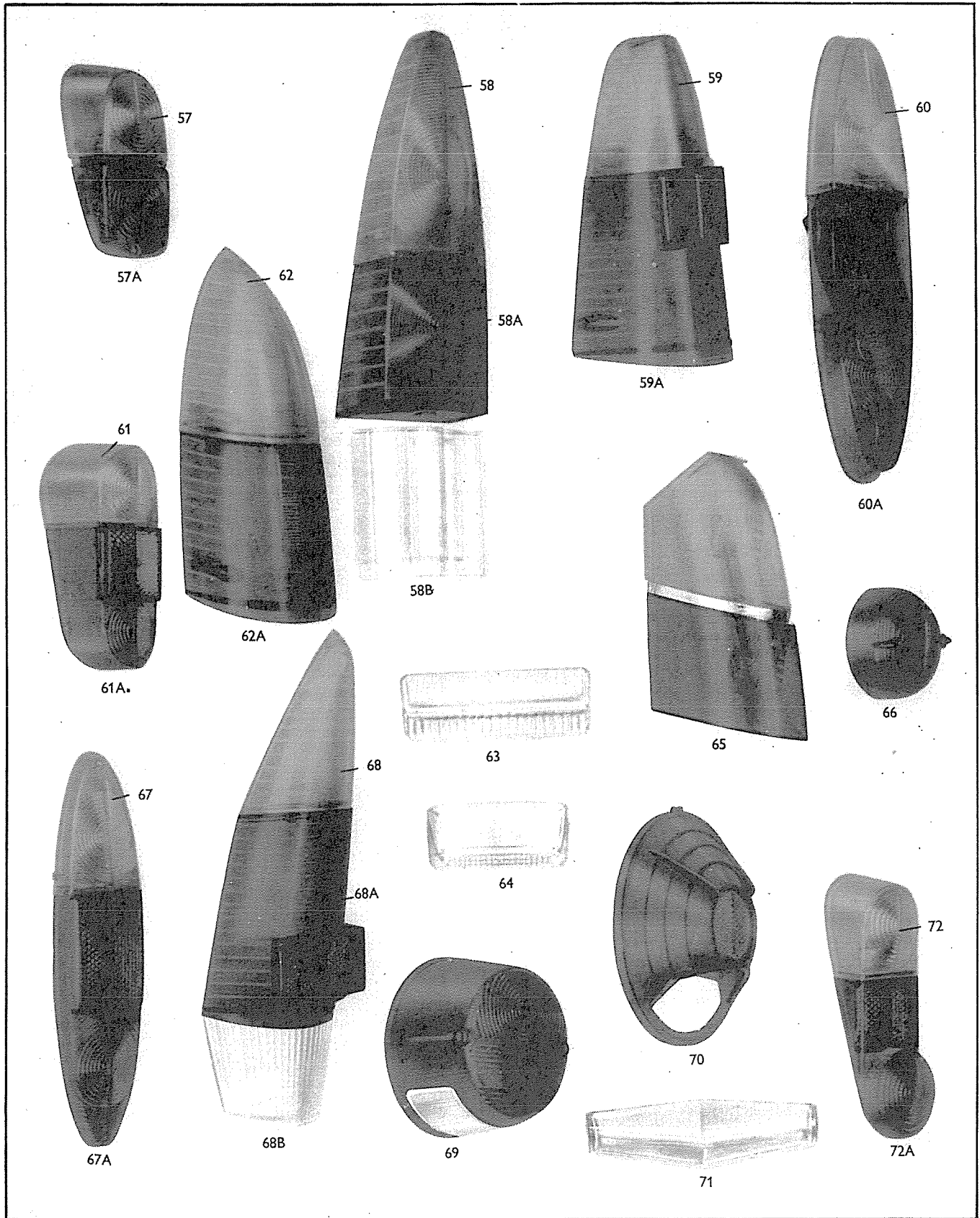

REAR LAMP LENSES

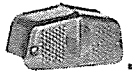

LENS CHART—continued

Part No.	Type	Illustration Reference	Fitted to	Description
54570227	Lens	57	627	Amber; circular fluted; used with 54570229.
54570228	Lens	57	627	Red; otherwise as 54570227.
54570229	Lens	57A	627	Red; circular fluted; used with 54570227.
54570251	Lens	114	621	Red; otherwise as 54570099; for illustration, see page K60.
54570255	Lens	58B	629	Clear; vertical flutes.
54570257	Lens	58	629	Amber; cone shaped.
54570318	Lens	112	631	Red; otherwise as 577854; for illustration, see page K60.
54570335	Lens	103	572	Red; otherwise as 576586; for illustration, see page K60.
54570354	Lens	31	467	Clear glass; window cover; for illustration see page K58.
54570358	Lens	115	607	Red; otherwise as 54570156; for illustration, see page K60.
54570359	Lens	115	607	Red; otherwise as 54570156, but left hand; for illustration, see page K60.
54570400	Lens	116	640	Red; otherwise as 54570179; for illustration, see page K60.
54570425	Lens	59	641	Red; shaped; used with 54570787.
54570436	Lens	60	642	Amber; cone shaped; used with 54570437.
54570437	Lens	60A	642	Red.
54570451	Lens	61	647	Amber; circular fluted; right hand.
54570466	Lens	61	647	Amber; circular fluted; left hand.
54570495	Lens	62	646	Amber; shaped.
54570507	Lens	58	629	Red; otherwise as 54570257.
54570520	Glass	63	645	Clear; dished; fluted.
54570537	Glass	64	644	Clear; dished.
54570544	Lens	62A	646	Red; domed; used with 54570495.
54570562	Lens	65	636	Amber; shaped.
54570563	Lens	66	637	Amber; domed; circular fluted.
54570581	Lens	58A	629	Red; shaped; used with 54570257.
54570589	Lens	67	654	Amber; shaped.
54570629	Lens	68	635	Amber; shaped; used with 54570631.
54570631	Lens	68A	635	Red; shaped; used with 54570629.
54570648	Lens	60	642	Red; otherwise as 54570436.
54570664	Glass	37	488	Red; circular fluted; for illustration, see page K58.
54570667	Lens	68B	635	Clear; fluted.
54570668	Lens	68	635	Red; otherwise as 54570629.
54570677	Lens	66	581	Red; domed; incorporating reflex.
54570678	Lens	61A	647	Red; shaped; used with 54570451; right hand.
54570738	Lens	88	567	Red; otherwise as 575722; for illustration, see page K60.
54570749	Lens	61A	647	Red; shaped; used with 54570466; left hand.
54570751	Lens	59	641	Amber; shaped; used with 54570787.
54570755	Lens	93	582	Red; circular; as 576153, but B.S. marking; for illustration, see page K60.
54570762	Lens	70	570	Red; circular; incorporating reflex.
54570766	Lens	105, inc. 105A	593	Amber flasher, red stop tail; incorporating reflex; for illustration, see page K60.
54570767	Lens	105, inc. 105A	593	Red flasher; otherwise as 54570766; for illustration, see page K60.
54570777	Lens	89	572	Red; shaped; incorporating reflex; for illustration, see page K60.
54570779	Lens	53	538	Red; domed; circular; for illustration, see page K58.
54570787	Lens	59A	641	Red; shaped; with reflex.
54570806	Lens	69	VP64	Red; clear window.
54570810	Lens	62	646	Red; shaped; otherwise as 54570495.
54570832	Glass	71	649	Clear; dish shaped.
54570915	Lens	110	620	Red; otherwise as 577728; for illustration, see page K60.
54570923	Lens	65	636	Red, otherwise as 54570562.
54570929	Lens	72	657	Amber; grooved.
54570959	Lens	67A	654	Red; incorporating reflex.
54570990	Lens	72A	657	Red; shaped; incorporating reflex.
54571012	Lens	61	647	Red; otherwise as 54570451.
54571013	Lens	61	647	Red; otherwise as 54570466.
54571036	Lens	67	654	Red, otherwise as 54570589.
54571070	Lens	77	548	Amber; otherwise as 574546; for illustration, see page K60.
54571071	Lens	77	548	Red; as 574546; for illustration, see page K60.
54571072	Lens	78	548	Red; domed; oblong shaped; otherwise as 574547; for illustration, see page K60.
54571112	Glass	92	594	Red; circular; deep domed; for illustration, see page K60.
54571199	Lens	72	657	Red; otherwise as 54570929.

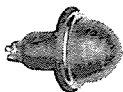

REAR LAMPS

VEHICLE APPLICATION REFERENCE

- 52114 1130 Tail lamp. Black finish; C.P.R., 1 1/2" dia.; 12v.; single contact; ruby lens; two-stud fixing. Jensen 3 1/2 litre 1946-47.
- 52285 488 Reverse lamp. C.P.R., 2 3/8" dia.; 12v.; single contact; clear lens; flexible body; flush fitting. Humber 'Hawk' Estate Car 1958-60; 'Super Snipe' Estate Car 1959-60. Riley 'Pathfinder' 1957. Vauxhall 'Wyvern', 'Velox' and 'Cresta' 1955-56.
- 52287 539 Rear flasher lamp. C.P.R., 3 3/8" dia.; 12v.; single contact; amber lens, lightly stippled; flush fitting. Bentley 'Continental' Sports Saloon 1955-60; Model 'S2' and 'Continental' Sports (except U.S.A.) 1960. Rolls-Royce 'Silver Wraith' (when fitted) 1956-59.
- 52288 539 Rear flasher lamp. C.P.R., 3 3/8" dia.; 12v.; single contact; amber lens, lightly stippled; flush fitting; as 52287 except for cable. Bentley 'Continental' Sports Saloon 1955-56; Model 'S2' and 'Continental' Sports (except U.S.A.) 1960. Rolls-Royce 'Silver Wraith' 1956-59.
- 52308 539 Reverse lamp. C.P.R., 3 3/8" dia.; 12v.; single contact; clear lens, lightly stippled; flush fitting. Bentley Model 'S' (Park Ward body) and 'Continental' Sports 1957-59. Rolls-Royce 'Silver Wraith' (Park Ward body) 1956-59.
- 52309 539 Reverse lamp. C.P.R., 3 3/8" dia.; 12v.; single contact; amber lens; flush fitting; as 52308 except for lens. Bentley Model 'S' and 'Continental' Sports 1957-59. Rolls-Royce 'Silver Wraith' (Park Ward body) 1956-59.
- 52314 585 Rear flasher lamp. Amber lens; rectangular shaped; 12v.; single contact; 42" cable; as 52395 except for voltage; flush fitting. Commer 2 1/5 ton 'Superpoise' (Petrol) and 3/5 ton 'Superpoise' (Diesel) 1955-60; 6 ton 'Superpoise' 1959-60.
- 52315 585 Rear flasher lamp. 24v.; as 52314 except for voltage. Commer 5/6 ton 'Superpoise' (Diesel) 1957-60.
- 52337 594 Rear flasher lamp. C.P.R., 2 3/8" dia.; 12v.; single contact; amber lens; flexible body; flush fitting. Austin 'Gipsy' and Austin-Healey 'Sprite' 1958-60. Berkeley Sports Car 1959-60. Elva 'Courier' 1959-60. Layton 'Jomar' (T.V.R.) 1959-60. Morgan 'Plus Four' 1955-60; 'Four Four' Series II 1959-60. Reliant 'Regal' Car and 5 cwt. Van 1959. Standard 'Eight' and 'Ten' 1958-60. Tornado 'Typhoon' 1959-60. Triumph TR3 1958-60.
- 52364 594 Rear flasher lamp. C.P.R., 2 3/8" dia.; 6v.; single contact; amber lens; flexible body; flush fitting; as 52337 except for voltage. Reliant 5 cwt. Van (Home) 1959.
- 52371 539 Rear flasher lamp. Sunken C.P.R., 3 3/8" dia.; 12v.; single contact; amber lens; flush fitting; less cables. Austin 'Cambridge' 1956-59; A55 Truck and Van 1958-60; A90 and A95 1956.
- 52459 539 Rear flasher lamp. 12v.; single contact; amber lens; 30" cable; flush fitting; less rim. Daimler SP250 1960.
- 52460 539 Rear flasher lamp. 12v.; single contact; red lens; 30" cable; flush fitting; less rim; as 52459 except for lens. Daimler SP250 (Export U.S.A.) 1960.
- 52503 539 Reverse lamp. C.P.R., 3 3/8" dia.; 12v.; single contact; clear lens; 21" cable; flush fitting. Bentley 'Continental' 1960.
- 53032 TR51-1 Reverse lamp. C.P. finish; 12v.; two single contact bulb holders; half clear and half ruby lens; two-stud fixing. Allard 16 (1947-49); 'L' Model 1949-51. Austin 25 cwt. Van and Ambulance 1948. Humber 'Imperial' and 'Pullman' 1946-47; 'Super Snipe' 1946. M.G. 1 1/2 litre 1947-53. Riley 1 1/2 litre 1949-55; 2 1/2 litre 1947-53. Rover 10, 12, 14 and 16 (Export) 1946-47. Sunbeam-Talbot 2 litre 1946-47.
- 53035 TR51-1 Reverse, tail and number plate lamp. C.P. finish; 12v.; two single contact bulb holders; half ruby and half clear lens; two-stud fixing. Rover 10, 12, 14 and 16 1946-47.
- 53049 ST53 Stop tail and number plate lamp. C.P.R.; overall dimensions 6 1/2" x 2 3/8"; 12v.; single contact ruby lens; four-stud fixing. Hillman 'Minx' 1948.
- 53080 288-3 Number plate illumination and reverse box. Black finish; C.P.R.; overall dimensions 28" x 5 1/2"; 12v.; single contact bulb holder; four-stud fixing. Bentley 4 1/2 litre Mk. VI 1946-51. Rolls-Royce 'Silver Wraith' 1946-59; 'Silver Dawn' 1953-55.
- †53093 467-2 Number plate illumination lamp. C.P. finish; overall dimensions 4 3/8" x 1 1/4"; 12v.; one single contact bulb holder; two-stud fixing. A.C. Cars 'Accea' 1958-60. A.F.N. 'Le Mans' (Export U.S.A.) 1951-54; 'Mille Miglia' 1951-54. Allard 16 (4-seater) 1947-49; 'J' Models 1949-56; 'L' Model 1949-51; 'K3' Model 1954-55; 'M' and 'P' Models (later) 1951-55; '21C' and '21Z' 1953-55. Alvis TB21 1952. Armstrong Siddeley 'Whitley' 1950-53. Aston Martin 2 litre 1947-49; DB3/S Competition 1956. Austin A30 1952-55; 'Seven' (850) De Luxe 1959-60; A40 Sports 1951-53; 'Princess' (later) 1956-60; Hire Car 1959-60; Austin-Healey '100', '100M', '100 Six' and '3000' 1954-60; 'Sprite' 1958-60; Hire Car 1959-60. Bentley 4 1/2 litre Mk. VI (Export U.S.A.) 1948. Bond 'Minicar' 1958-60. Bristol 2 litre 1947-48; '400' 1949-50; '404' 1954-55. Commer 8 cwt. and 'Express' Delivery Van and Truck 1949-60. Daimler 'Conquest' Roadster 1954-55; Drophead Coupé 1956-57; SP250 1960. Dellow Sports 1952-57. Elva 'Courier' 1959-60. Fairthorpe All Models 1959-60. Frazer Nash 'Mille Miglia', 'Targo Florio' and 'Sebring' Hard Top 1955. Healey 'Silverstone' 1950. Hillman 'Minx' 1948-53; 'Minx' Estate Car 1955-57. Jaguar XK-SS 1958. Jensen '541' and '541R' 1954-55. Jowett 'Javelin' 1952-54; 'Jupiter' 1951-54. Lagonda 2 1/2 litre 1949-52. Lanchester LD10 1951. Layton 'Jomar' (T.V.R.) 1959-60. Meynell All Models 1952. M.G. 'Midget', MGA and MGA 1600 1949-60. Morgan 'Plus Four' 1955-60; 'Four Four' Series II 1956-60. Morris 'Minor' 4-door 1951; 'Minor Traveller' 1954-56; 'Mini-minor' (850) De Luxe 1959-60; 'Cowley' Saloon 1955-59; 'Oxford' Saloon 1950-51 and (later) 1954-59; 'Hindustan' 1955-60; 'Six' 1948-50 and 1953-54; 'Isis' 1956-58. Morrison Electricians 1 ton D4 and 25 cwt. E 1955 Paramount Roadster and Coupé 1951-53. Reliant 'Regal' Car (6 volt) 1953-54. Rover '60' and '75' 1948-49; 'Landrover' and Station Wagon 1951. Singer 9 Roadster (Export U.S.A.) 1951. Smiths Delivery Vehicles 'Mobile Shop' 1956-58. Standard 'Vanguard' Saloon (Export U.S.A.) 1950-55; Estate Car 1954. Stallard 'Doratti' 1954-55. Tornado 'Typhoon' 1959-60. Triumph TR2 (Export Holland) 1957; TR2 1958-60; 'Mayflower' 1951-53; 'Herald' (later) 1960. Vauxhall 'Wyvern' 1948-51. Wolseley 'Fifteen Hundred' 1958-60.
- 53095 464 Stop tail lamp. C.P.R.; overall dimensions 4 1/2" x 2 1/2"; 12v.; two single contact bulb holders; clear lens; two ruby bulb covers; deep box type body; flush fitting. Austin A125 'Sheerline' 1948-54; Ambulance and Hearse 1951-53.
- 53097 469 Number plate illumination and reverse light. C.P. finish; overall dimensions 6 3/8" x 1 1/2"; 12v.; three single contact bulb holders; two-stud fixing; vertical mounting. Allard 'M' and 'P' Models (Export U.S.A.) 1951; 'P2' Model (Export U.S.A.) 1953-55; Alvis TA21 1951-53; TC21 and TC21/100 'Grey Lady' and 'Tickford' Coupé 1954-55. Armstrong Siddeley 'Sapphire' 1953-55; 'Sapphire 234' and 'Sapphire 236' 1956-58; 'Sapphire 346 Saloon' 1956-58; 'Sapphire 346' Limousine 1956-59; 'Star Sapphire' 1959-60. Aston Martin All Models (except DB3S) 1951-60. Bristol 'X404' 1954; '405' 1955-58. Daimler 2 1/2 litre Models (except 'Consort') 1950-53. Healey 'Tickford' Saloon 1951-54; 'Abbot' Drop-head Coupé 1952-54. Jensen 'Interceptor' 1950-55. Jowett 'Javelin' De Luxe 1952-54. Lagonda 3 litre 1954-58. Lea Francis 14 1950-54; 18 4 Light Saloon 1952-54; 1 1/2 and 2 1/2 litre Sports 1949-54.
- 53097 469—continued
Riley 2 1/2 litre Open Sports 1949. Rover '60' (Export N.A.D.A.) 1954; '60', '75' and '90' 1955-57; '75' 1950; '75' (Export N.A.D.A.) 1953-54; '90' (Export N.A.D.A.) 1954. Singer 'SM1500' 1949-54; 'Hunter' 1955-56. Standard 'Vanguard' Saloon 1948-53; 'Vanguard' 1955-60.
- 53099 472 Stop tail lamp. Ruby glass cover; 2 3/8" dia.; 12v.; double contact; two-stud fixing. Jowett 'Javelin' 1948-49.
- 53100 296 Number plate illumination box. Black finish; overall dimensions 2 1/2" x 5 1/2"; 12v.; one single contact bulb holder; four-stud fixing. Aston Martin 2 litre 1949-50. Austin A125 Limousine 1952; A135 'Princess' and Limousine 1948-56; Ambulance 1955. Lea Francis 18 6 Light Saloon 1950-53.
- 53101 467-2 Number plate illumination lamp. Black finish; overall dimensions 4 3/8" x 1 1/4"; 12v.; one single contact bulb holder; two-stud fixing. Allard 'M' and 'P' Models 1949-50. Armstrong Siddeley 1/2 ton Pick-up Truck (Export only) 1957. Austin A30 'Seven' 1956; 'Seven' (850) 1959-60; A35 1957-60; A40 1948-54; A40 Van, 'Countryman' and Truck 1956; A55 Truck and Van 1958-60; A70 1948-55; A90 1949; Taxi 1955-60; Hire Car 1955-58; 'Champ' (Civilian) 1954-56; 'Cargo' Truck (Civilian) 1954-55; LD Models 1955-60; 2 and 5 ton Trucks Series II 1953-55; 3 ton Trucks Series III 1955; Series III Trucks 1956-60; Series IVFF Trucks 1959-60; Series IVFG Trucks 1960; 101 Van and 'Gipsy' 1958-60; 152 Range, 301 Range and Series III 1957-60. Beardmore Taxi Mk. VII 1955-58. Citroen DS19 1956-59; 2CV (Van) 1954-60. Commer Medium Pick-up Truck Mk. IV 1951-54. Isetta (Great Britain) '300' 1957-60. Jensen Lightweight 1955; 'Tempo 1500' 1958-60. Morris 'Minor' (2-door) 1948-56; 'Minor 1000' 1957-60; 'Mini-minor' (850) 1959-60; 'Cowley' Van and Truck 1950-53; 'Oxford' Saloon 1948-49 and 1952-54; 'Traveller' 1955-57; 'Oxford' Taxi and Hire Car 1951; 'Six' 1951-52; 'Isis' 1956-57; Half Ton Van and Pick-up Truck 1954-60. Morris Commercial 15/20 cwt. (PV) 1953; LC Models 1953-60; FVS and FVS12/5 1954-55; FVSO and NV 1954; FVSO12/5, NV12/3, NVO 12/3 and NVO11/5 1955; NVO 1953; NVS, NVS12/3 and NVS13/5 1953-55; 'J' and 'JB' Vans 1949-60; 'J2' Range 1957-60; LD Models 1954-60; Series III Trucks and Coach 1956-60; Series IVFG 1960; Series IVFF Trucks and Coach 1959-60. Morrison Electricians 1 ton D4, 25 cwt. E and 20 cwt. EH 1956-60; BM, D1, F and FL Models and GT Tractor 1958-60. Rover 'Landrover' 1952-59. Singer 4AC and 4AD 1952-55. Smiths Delivery Vehicles 2 ton (Diesel) 1953; Pick-up Truck (Export Holland and Belgium) 1956-59. Standard 12 cwt. Van and Pick-up Truck 1948-57. Triumph 'Mayflower' 1950-53. Trojan 20/25 cwt. Van 1959-60.
- 53113 461 Stop lamp. C.P.R., 2 3/8" dia.; 12v.; single contact; ruby lens; special location; flush fitting. Bentley 4 1/2 litre Mk. VI 1951; 4 1/2 litre Mk. VI (Export) 1947-48; 'Continental' Sports 1952. Rolls-Royce 'Silver Wraith' 1951-55.
- 53114 288-3 Number plate illumination and reverse box. Black finish; C.P.R.; overall dimensions 28" x 5 1/2"; four single contact bulb holders; four-stud fixing. Bentley 4 1/2 litre Mk. VI (Export) 1947-50. Rolls-Royce 'Silver Wraith' (Special) 1956-59.
- 53116 476 Tail, reverse and number plate lamp. C.P. finish; 12v.; two single contact bulb holders; half ruby and half clear lens; two-stud fixing. Austin A125 Limousine 1953-54; Ambulance and Hearse 1953-55. Daimler 2 1/2 litre 'Consort' 1950-53. Healey 16 1948-49. Humber 'Imperial' and 'Pullman' 1950; 'Super Snipe' 1947-50; 'Super Snipe' (heavy duty) 1951-52.
- 53117 476 Stop tail and number plate lamp. C.P. finish; 12v.; two single contact bulb holders; ruby lens; two-stud fixing. Austin A125 Limousine 1953-54; Ambulance and Hearse 1953-55. Daimler 2 1/2 litre 'Consort' 1950-53. Healey 16 1948-49. Humber 'Super Snipe' 1947-50; 'Super Snipe' (heavy duty) 1951-52. Vauxhall 'Wyvern' and 'Velox' 1948-49.

REAR LAMPS

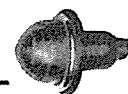

VEHICLE APPLICATION REFERENCE—continued

- 53128 464 Reverse lamp. C.P.R.; overall dimensions $4\frac{3}{4} \times 2\frac{1}{2}$ "; 12v.; single contact; clear lens; shallow box type body; flush fitting.
Austin A135 'Princess' and Limousine 1955.
Bentley $4\frac{1}{2}$ litre 1948-51.
Rolls-Royce 'Silver Wraith' (Export Switzerland) 1951-55.
- 53130 469 Number plate and reverse lamp. C.P. finish; overall dimensions $6\frac{1}{2} \times 1\frac{1}{2}$ "; 12v.; two single contact bulb holders; three-stud fixing; vertical mounting; special for Wolseley.
Wolseley 'Four Fifty' 1949-53; 'Six Eighty' 1949-54.
- 53131 482 Stop tail lamp. C.P.R.; $2\frac{3}{8}$ " dia.; 12v.; double contact; ruby lens; flush fitting.
A.C. Cars 16 1949.
Commer 8 cwt. Van and Estate Car 1949.
Morris 'Oxford' Saloon 1948-49.
Singer 'SM1500' 1949-50.
- 53135 485 Number plate lamp. C.P. finish; overall dimensions $8 \times 1\frac{1}{2}$ "; 12v.; two single contact bulb holders; two-stud fixing; special for Humber.
Humber 'Hawk' 1949-54; 'Super Snipe' 1951-52.
- 53149 469 Number plate illumination and reverse lamp. C.P. finish; overall dimensions $6\frac{1}{2} \times 1\frac{1}{2}$ "; 12v.; three single contact bulb holders; two-stud fixing.
Jaguar $2\frac{1}{2}$ and $3\frac{1}{2}$ litre 1949-51.
- 53152 464 Number plate illumination lamp. C.P. rim and cowl; overall dimensions $4\frac{1}{2} \times 2$ "; 12v.; one single contact bulb holder; flush fitting.
Austin A90 1950-52.
- 53153 464 Stop tail and flasher lamp. C.P.R.; overall dimensions $4\frac{3}{4} \times 2\frac{1}{4}$ "; 12v.; one single contact and one double contact bulb holder; ruby lens; deep box type body; flush fitting; Export U.S.A. only.
Allard 'P2' Model 1952-54; '21C' and '21Z' Models 1953-54.
Alvis TA21 1951-53; TC21 and TC21/100 'Grey Lady' and 'Tickford' Coupé 1954; TB21 1952.
Daimler $2\frac{1}{2}$ litre (except 'Consort') 1952-53; 3 litre 'Regency' Saloon and Coupé 1953; 'Conquest' ('Century') Saloon and 'Conquest' Coupé 1954-55.
Lanchester 14 1952-53.
Lea Francis 14 1951-54; 18 4 Light Saloon 1953-54; 18 6 Light Saloon 1953.
Rover '60' 1954; '75' and '90' 1950-54.
- 53161 469 Number plate illumination and reverse lamp. C.P. finish; overall dimensions $6\frac{1}{2} \times 1\frac{1}{2}$ "; 12v.; three single contact bulb holders; two-stud fixing.
Alvis TC108G 1956-57; TD21 1958-60.
Armstrong Siddeley 'Star' Limousine 1960.
Daimler 3 litre 'Regency' Saloon and Coupé 1953; 'Conquest' ('Century') Saloon 1954-58; 'Conquest' Drophead Coupé 1954-55.
Hillman 'Minx' (special orders) 1952.
Jaguar XK120 1949-54; XK140 1955-57.
Jensen '541' and '541R' 1956-60.
Lanchester 14 1952-53; 'Sprite' 1955-56.
Peerless 'Gran Turismo' 1959-60.
Riley 1 1/2 litre (later) 1955-60; 'One-Point-Five' 1958-60; 'Two-Point-Six' 1958-59.
Rover '75' 1951.
Triumph TR3 (Export Holland) 1957.
- 53164 467-2 Number plate illumination lamp. C.P. finish; overall dimensions $4\frac{3}{8} \times 1\frac{1}{2}$ "; 12v.; one single contact bulb holder; two-stud fixing.
Bentley $4\frac{1}{2}$ litre (Export U.S.A.) 1951-52.
Rolls-Royce 'Silver Wraith' (Export U.S.A.) 1952-59; 'Silver Dawn' (Export U.S.A.) 1953-55.
- 53171 469 Number plate illumination lamp. Black finish; overall dimensions $6\frac{1}{2} \times 1\frac{1}{2}$ "; 12v.; two single contact bulb holders; two-stud fixing; horizontal mounting.
Standard 12 cwt. Van 1950-57.
- 53172 484 Stop tail lamp. C.P.R.; overall dimensions $4\frac{1}{2} \times 2\frac{1}{2}$ "; 12v.; one double contact bulb holder; ruby lens; radiused to contour of car wing; flush fitting.
Commer 8 cwt. Van (later) 1951-52.
Hillman 'Minx Magnificent' 1948; 'Minx' 1949-53.
- 53173 464 Stop tail lamp. C.P.R.; overall dimensions $4\frac{1}{2} \times 2\frac{1}{2}$ "; 12v.; double contact; ruby lens; shallow box type body; flush fitting.
Allard 'J', 'J2' and 'J2X' Models (Export U.S.A.) 1949-50.
Humber 'Hawk' 1949-53.
Jaguar $2\frac{1}{2}$ and $3\frac{1}{2}$ litre 1949-51.
Lanchester LD10 1951.
- 53174 464 Stop tail lamp. C.P.R.; overall dimensions $4\frac{1}{2} \times 2\frac{1}{2}$ "; 12v.; one double contact bulb holder; ruby lens; shallow box type body; flush fitting; Export U.S.A. only.
Alvis TA21 1951-53; TC21 and TC21/100 1954-55; TB21 1952.
Healey 'Tickford' Saloon and 'Abbot' Drophead Coupé (later) 1952-54.
Humber 'Hawk' (Export U.S.A. and Canada) 1950-52; 'Hawk' (later) 1953-54.
Lagonda 3 litre 1954-55.
Sunbeam 'Alpine' (Export U.S.A.) 1953-54.
Sunbeam-Talbot '90' 1950; '90' (Export U.S.A.) 1951-53.
- 53175 464 Stop tail and reverse lamp. C.P.R.; overall dimensions $4\frac{1}{2} \times 2\frac{1}{2}$ "; 12v.; one single contact and one double contact bulb holder; one ruby bulb cover; special modernised body and lens; flush fitting.
Sunbeam 'Alpine' 1953-54.
Sunbeam-Talbot 2 litre 1947; '80' 1948-50; '90' 1948-54.
- 53177 464 Stop tail and reverse lamp. C.P.R.; overall dimensions $4\frac{1}{2} \times 2\frac{1}{2}$ "; 12v.; one single contact and one double contact bulb holder; one ruby bulb cover; shallow box type body; flush fitting.
Humber 'Imperial' and 'Pullman' 1948-54.
- †53178 488 Stop tail lamp. C.P.R.; $2\frac{3}{8}$ " dia.; double contact; ruby lens; rubber body; flush fitting.
A.C. Cars 16 1950-55.
A.F.N. 'Le Mans' (Export U.S.A.) 1951-54; 'Mille Miglia' 1951-54.
Allard 'J', 'J2' and 'J2X' Models 1949-55; 'J2R' Model 1956; 'P2' Model 1952.
Armstrong Siddeley $\frac{1}{2}$ ton Pick-up Truck (Export only) 1957.
Aston Martin DB2 and DB2/4 1951-57; DB3/S Competition 2-seater 1956.
Austin A30 De Luxe 1952-53; A30 1953-56; A35 Van and 'Countryman' 1957-60; A40 'Somerset' 1952-54; A40 Van, 'Countryman' and Truck 1956; A40 Sports 1951-53; A70 1951-55; 'Regency' and Hire Car 1955-58; 'Champ' (Civilian) 1954-56; Cargo Truck (Civilian) 1954-55; LD Models 1955-60; 2 and 5 ton Trucks Series II 1953-55; 3 ton Trucks Series II 1955; Series III Trucks and Coach 1956-60; Series IVFF Trucks 1959-60; 101 Van 1958-60; 301 range (except 301FC) 1957-60; Austin-Healey '100' and '100M' 1954-56.
Beardmore Taxi Mk. VII 1955-58.
Bedford CA Van 1953-60.
Bristol 'X404' (Arnolt body) 1954.
Citroen 15 (Export) 1949-50.
Commer Estate Car 1949; 8 cwt. Van (later) 1951-52; 'Express' Delivery Van and Truck 1953-60; 'Cob' 1957; 25 cwt. Forward Control 1955-56; $1\frac{1}{2}$ ton Forward Control Mk. V 1956-59; 1 ton Forward Control (later) 1959-60; 25 cwt. 'Superpoise' Van 1955-56; Medium Pick-up Truck Mk. IV 1951-54; $\frac{3}{4}$ ton 'Superpoise' Van and Truck Mk. V 1956-60; 2/5 and 3/5 ton 'Superpoise' (Petrol) 1955-60; 6 ton 'Superpoise' 1959-60; 4, 5 and 6 ton Forward Control 1959-60; 5 ton 'Superpoise' 1955-59; 7 ton Forward Control, Fire Tender or Pump 1955-60.
Daimler 3 litre 'Regency' Coupé only 1953.
Dellow Sports 1952-57.
Healey 'Silverstone' 1950.
Hillman 'Minx' 1953-54 and (later) 1956; 'Minx' Estate Car 1949-57; 'Husky' 1955-57.
Humber 'Super Snipe' 1953-57.
Isotta (Great Britain) '300' 1957-59.
Jaguar $2\frac{1}{2}$ litre (later) 1951; $3\frac{1}{2}$ litre 1951-54; XK120 1949-54.
Jensen 'Interceptor' 1951-55; '541' and '541R' 1954-55; Lightweight 1955.
Jowett 'Jupiter' 1951-52; 10 cwt. 'Bradford' Van 1953-54.
Karrier 'Bantam' and 'Gamecock' 1955-60; $1\frac{1}{2}$ ton Passenger Chassis 1957-60.
Lexus Mk. IX 1958-59.
Meynell All Models 1952.
M.G. 'Midget' 1953-55.
Morgan 'Plus Four' 1951-58; 'Four Four' Series II (Ford engine) 1956-58.
Morris 'Minor Traveller', Quarter Ton Van and Truck 1954-60; 'Cowley' Van and Truck 1950-53; 'Oxford Traveller' 1953-56; 'Oxford' Taxi and Hire Car 1951; 'Six' Saloon 1948-49; 'Isis Traveller' 1956-57; Half Ton Van and Pick-up Truck 1954-56.
- 53178 488—continued
Morris Commercial 15/20 cwt. (PV) 1953; LC Models 1953-60; FVS, FVS12/5, FVSO, NVO, FVS012/5, NV, NV12/3, NVO12/3 and NVO 11/5 1954-55; NVS, NVS12/3 and NVS13/5 1953-55; 10 cwt. 'J' Van 1949-57; 'JB' Van 1958-60; LD Models 1954-60; Series III Trucks and Coach 1956-60; Series IVFG Trucks 1958-60; Morrison Electricars 25 cwt. Austin Electricar B1/LH 1955-56; 1 ton D4 and 25 cwt. E 1955-59; 20 cwt. EH (later) 1959-60; BM, D1, F and FL Models 1955-60.
Paramount Cars Roadster and Coupé 1951-53.
Reliant 'Regal' Car (6 volt) 1953-54.
Renault 4CV Saloon 1952-55.
Riley 'Pathfinder' 1954-57.
Rover 'Landrover' (Export N.A.D.A.) 1951-54; Station Wagon 1951.
Singer 9 Roadster (Export U.S.A.) 1951; 4AC and 4AD 1952-55; 'SM1500' (later) 1950-54.
Smiths Delivery Vehicles Standard Drive Models (Electric), 1 and 2 ton (Diesel) 1953-55; 14, 20 and 30 cwt. (Electric) and Mobile Shop 1956-58.
Standard 'Eight' and 'Ten' 1954-55; 'Eight' and 'Ten' (Export Holland and Belgium) 1957.
Swallow Coachbuilding 'Doretts' 1954-55.
Triumph 'Mayflower' 1950.
Wolseley 'Four Forty-Four' 1953-56; 'Four Fifty' and 'Six Eighty-Four'; 'Six Ninety' 1955-56; 'Fifteen Fifty' 1957-59.
- 53179 464 Stop tail lamp. C.P.R.; overall dimensions $4\frac{1}{2} \times 2\frac{1}{2}$ "; 12v.; double contact; ruby lens; shallow box type body complete with windows; flush fitting.
Standard 'Vanguard' Saloon 1948-51; 'Vanguard' Estate Car 1950-56; 'Vanguard' Saloon (Export U.S.A.) 1953.
- 53180 464 Stop tail lamp. C.P.R.; overall dimensions $4\frac{1}{2} \times 2\frac{1}{2}$ "; 12v.; one double contact bulb holder; ruby lens; shallow box type body; flush fitting.
Standard 12 cwt. Van and Pick-up Truck 1950-57.
- 53183 464 Stop tail and flasher lamp. C.P.R.; overall dimensions $4\frac{1}{2} \times 2\frac{1}{4}$ "; 12v.; one single contact and one double contact bulb holder; shallow box type body; flush fitting; Export U.S.A. only.
Armstrong Siddeley 'Sapphire' 1953-55.
Daimler DC27 Ambulance 1951-54.
Healey 'Sportsmobile' 1949.
Humber 'Super Snipe' 1951-52.
Jaguar $2\frac{1}{2}$ litre 1949-51; $3\frac{1}{2}$ litre 1950-51.
Lea Francis Mk. V and Mk. VI and 18 6 Light Saloon 1950.
Standard 'Vanguard' Saloon 1950-51.
Sunbeam-Talbot '90' 1954.
- 53184 464 Stop tail and reverse lamp. C.P.R.; overall dimensions $4\frac{1}{2} \times 2\frac{1}{4}$ "; 12v.; one single contact and one double contact bulb holder; clear lens; one red bulb cover; shallow box type body; flush fitting.
Allard 'J', 'J2' and 'J2X' (Export U.S.A.) 1950-55; 'K3' Model 1955; 'M' and 'P' Models 1949-51; 'P2' Model 1953; '21C' and '21Z' 1955.
Rover '60' and '75' 1948-49.
- †53189 No. 1 Mk. I Number plate illumination lamp. Primer finish; single contact; spring loaded cover; clear window.
Commer 3 ton four-wheel-drive Cross Country Vehicle 1956.
- 53193 461 Stop tail lamp. C.P.R.; $2\frac{3}{8}$ " dia.; 12v.; double contact; ruby lens; special location; flush fitting.
Bentley $4\frac{1}{2}$ litre Mk. VI 1946-51; $4\frac{1}{2}$ litre Mk. VI (Export U.S.A.) 1951; $4\frac{1}{2}$ litre Mk. VII and 'Continental' Sports 1952-54.
Lea Francis 14 1948.
Rolls-Royce 'Silver Wraith' 1946-50; 'Silver Wraith' (Export U.S.A.) 1951-55; 'Silver Dawn' (Export U.S.A.) 1953-55.
- 53194 461 Stop tail lamp. C.P.R.; $2\frac{3}{8}$ " dia.; 12v.; double contact; ruby lens; flush fitting.
A.C. Cars 16 1948.
Aston Martin 2 litre 1947-50.
Austin A90 1949-52.
Daimler 27 Limousine and 36 1953.
Healey 'Tickford' Saloon 1951-52; 'Abbot' Drophead Coupé 1952.
Invicta 'Black Prince' 1948-49.
Jensen 4 litre 'Interceptor' 1950.
Jowett 'Javelin' 1950-54; 'Jupiter' (later) 1952-54.
Lagonda $2\frac{1}{2}$ litre 1949-52.

†Quote voltage when ordering

C.P. . . Chromium plated

C.P.R. . . Chromium plated rim

N.A.D.A. . . North American Dollar Area

continued



REAR LAMPS

VEHICLE APPLICATION REFERENCE—continued

- 53198 464 Stop tail and reverse lamp. C.P.R.; overall dimensions $4\frac{3}{4} \times 2\frac{1}{4}$ "; one double contact and one single contact bulb holder; clear lens; one ruby bulb cover; shallow box type body; flush fitting.
Armstrong Siddeley 'Whitley' Saloon 1950-53; Limousine 1951-52.
Austin A125 Limousine 1951-54; Ambulance (DA1) and Hearse (DH1) (later) 1953-55.
Lea Francis 14 (later) 1952-53; 18 6 Light Saloon 1951-53.
- 53199 464 Stop tail lamp. C.P.R.; overall dimensions $4\frac{3}{4} \times 2\frac{1}{4}$ "; 12v.; one double contact bulb holder; ruby lens; deep box type body; flush fitting.
Allard 'P2' Model (later) 1953-54.
Armstrong Siddeley 'Sapphire' 1955.
Daimler 3 litre 'Regency' Saloon and Coupé 1953; 'Conquest' ('Century') Saloon 1954-55.
Lanchester 14 1952-53.
Lea Francis 14 and 18 4 Light Saloon 1951; 2½ litre Sports 1951-54.
Rover '60' and '90' 1954; '75' 1950-54.
- 53200 471 Stop tail lamp. C.P.R.; overall dimensions $2\frac{3}{8} \times 4\frac{1}{8}$ "; 12v.; double contact; ruby lens; flush fitting.
Austin A40 1948-52; A70 1948-50.
Citroen 15 (Export U.S.A.) 1953-54; 23 (Export U.S.A.) 1953.
M.G. 'Midget' 1950-52.
Morris 'Minor' 2-door (Export) 1949; 'Minor' 2-door, 'Oxford' and 'Six' Saloon 1950-53.
Wolseley 'Four Fifty' and 'Six Eighty' 1950-53.
- 53201 464 Stop tail and reverse lamp. C.P.R.; overall dimensions $4\frac{3}{4} \times 2\frac{1}{4}$ "; 12v.; two double contact bulb holders; clear lens; one ruby bulb cover; shallow box type body; flush fitting.
Austin 'Princess' and Limousine 1948.
Bristol 2 litre 1947-48; '400' 1949-50; '401' 1949-53; '403' 1954; '404' 1954-55.
- 53202 464 Stop tail and reverse lamp. C.P.R.; overall dimensions $4\frac{3}{4} \times 2\frac{1}{4}$ "; 12v.; two double contact bulb holders; clear lens; one ruby bulb cover; special channel; shallow box type body; flush fitting.
Austin A125 'Sheerline' 1953-54; 'Princess' and Limousine 1949-55.
- 53203 464 Stop tail and reverse lamp. C.P.R.; overall dimensions $4\frac{3}{4} \times 2\frac{1}{4}$ "; 12v.; one single contact and one double contact bulb holder; clear lens; one ruby bulb cover; shallow box type body; flush fitting.
Armstrong Siddeley 'Sapphire' 1953-54.
Daimler DC27 Ambulance 1949-54.
Healey 'Sportsmobile' 1949.
Humber 'Super Snipe' 1951-52.
Lea Francis 14 1950-52; 18 6 Light Saloon and 2½ litre Sports 1950.
- 53207 464 Stop lamp. C.P.R.; overall dimensions $4\frac{3}{4} \times 2\frac{1}{4}$ "; 12v.; single contact; ruby lens; shallow box type body; flush fitting.
Bentley 4½ litre Mk. VI (Export Switzerland) 1946; 4½ litre Mk. VI (Export) 1951.
Rolls-Royce 'Silver Wraith' (Export Holland and Switzerland) 1951-54; 'Silver Dawn' (Export Switzerland) 1953-55.
- 53210 488 Reverse lamp. C.P.R., $2\frac{3}{8}$ " dia.; 12v.; single contact; clear lens; rubber body; flush fitting.
Morris 'Oxford' Taxi and Hire Car 1951.
Riley 'Pathfinder' 1954-56.
Vauxhall 'Wyvern' (special orders) 1952-54.
- 53211 488 Stop tail lamp. C.P.R., $2\frac{3}{8}$ " dia.; 12v.; double contact; ruby lens; flush fitting; less body, but with special rubber base.
Triumph 'Mayflower' 1951-53.
- 53215 512 Number plate illumination, reverse and boot lamp. C.P. finish; overall dimensions $15\frac{1}{4} \times 4\frac{1}{4}$ "; 12v.; four single contact bulb holders; two-stud fixing.
Jaguar Mk. V (later) 1951-52; Mk. VII 1952; 2½ litre 1951.
- 53218 515 Stop tail lamp. 12v.; double contact; two-stud fixing; special for Vauxhall.
Vauxhall 'Wyvern' and 'Velox' 1952-56.
- 53223 472 Reverse lamp. 12v.; single contact; frosted moulded lens; two-stud fixing.
Jowett 'Javelin' De Luxe 1951.
- 53224 472 Number plate lamp. 12v.; single contact; clear moulded lens; two-stud fixing.
Jowett 'Javelin' 1950-51.
- 53226 464 Stop tail lamp. C.P.R.; overall dimensions $4\frac{3}{4} \times 2\frac{1}{4}$ "; 12v.; one double contact bulb holder; red lens; special shallow box type body; flush fitting.
Daimler 2½ litre (except 'Consort') 1950-51.
Humber 'Hawk' (standard extra) 1953-54.
- 53227 464 Stop tail and flasher lamp. C.P.R.; overall dimensions $4\frac{3}{4} \times 2\frac{1}{4}$ "; 12v.; one single contact and one double contact bulb holder; shallow box type body; flush fitting.
Humber 'Imperial' and 'Pullman' (Export U.S.A.) 1951-53.
- 53238 527 Number plate illumination and reverse lamp. C.P. cover; overall dimensions $3\frac{1}{4} \times 4\frac{3}{8}$ "; 12v.; two single contact bulb holders; two-stud fixing.
Humber 'Super Snipe' 1953-57.
- †53244 525 Stop tail and number plate lamp. Ruby cover; clear window; two-stud fixing.
A.C. Cars 16 (Export) 1948; 'Petite' 1953-57.
Austin 8 (6 volt) 1945-47; 10 1946-47; A30 1952-54.
Lotus Mk. IX 1958-59.
Reliant 'Regal Four' (Export only) 1959-60.
Standard Pick-up Truck 1957.
Triumph TR2 1955-57.
- 53256 529 Tail and number plate lamp. 6v.
Geo. Fitt Invalid Carriage (Villiers Mk. VI engine) 1951-55.
Invacar Invalid Carriage 1951-55.
Reliant 750 c.c. 4 cylinder 3-wheeler 1947-54.
Vernon's Industries Invalid Carriage 1951-54.
Wessex Industries Delivery Van 1952-55.
- 53258 469 Number plate illumination and reverse lamp. C.P. finish; overall dimensions $6\frac{1}{8} \times 1\frac{1}{8}$ "; 12v.; three single contact bulb holders; two-stud fixing.
Rover '60' and '90' 1954; '75' 1952-54; '60' and '105' 1958-59; '80' and '100' 1960.
- 53275 469 Number plate illumination and reverse lamp. Black finish; overall dimensions $6\frac{1}{8} \times 1\frac{1}{8}$ "; 12v.; three single contact bulb holders; two-stud fixing.
Wolseley 'Four Forty-Four' 1953-56; 'Fifteen Fifty' 1957-59.
- 53277 465 Number plate illumination lamp. C.P. finish; overall dimensions $17 \times 1\frac{1}{4}$ "; 12v.; two single contact bulb holders; three-stud fixing.
Sunbeam 'Alpine' 1953-54.
Sunbeam-Talbot '80' 1948-50; '90' 1948-54.
- 53278 532 Number plate illumination lamp. Clear glass cover; overall dimensions 3×3 "; 12v.; one single contact bulb holder; flange fixing.
Austin A90 and A95 1957.
Commer 'Cob' Light Van 1957-60.
Daimler 'Empress' Saloon, 'Regency' (and 'Sportsman') and 'Regina' Limousine 1955; 3½ litre 'One-O-Four' Saloon 1956-59; 'One-O-Four' Ladies' Model 1956; 4½ litre Limousine 1956-60; 'Majestic' 1959-60.
Hillman 'Minx' All Models (except Estate Car) 1953-60; 'Husky' 1955-60; 'Hawk' 1955-57.
Singer 'Gazelle' 1957-60.
Sunbeam 'Alpine' Sports 1959-60; 'Rapier' 1956-60.
- 53280 523 Stop tail and flasher lamp. Oval plastic rim, aluminised; 12v.; one single contact and one double contact bulb holder; red lens; flush fitting.
Austin 'Metropolitan' 1958-60.
Nash 'Metropolitan' 1954-56.
- 53288 471 Stop tail lamp. C.P.R.; overall dimensions $2\frac{3}{8} \times 4\frac{1}{8}$ "; 12v.; double contact; ruby lens; flush fitting.
Morris 'Minor', 'Oxford' and 'Six' (later) 1953-54.
Wolseley 'Four Fifty' (later) 1953; 'Six Eighty' (later) 1953-54.
- 53290 531-1 Stop tail and reverse lamp. Three separate lenses—red reflex, ruby and clear; 12v.; one single contact and one double contact bulb holder; flush fitting.
Standard 'Vanguard' Saloon (later) 1953-55; 'Vanguard' Saloon (Export U.S.A.) 1953.
- 53291 537 Bracket for number plate illumination lamp. Overall dimensions $4\frac{3}{8} \times 1\frac{1}{4}$ "; 12v.; two single contact bulb holders.
Morris Quarter Ton Van (and G.P.O.) and Pick-up Truck 1954-60.
- 53295 533 Stop tail and number plate lamp. C.P.R., 4" dia.; 12v.; three double contact bulb holders; red lens; two-stud fixing.
Austin B.M.C. 7 ton Series III Petrol Tanker 1958; 3/4 and 3/5 ton Series III Petrol Tanker 1957-60.
Morris Commercial 15/20 cwt. PV (G.P.O. only) 1953; LC4 and LC5 (LCO \times 5 G.P.O. Models) 1953-59; 3 ton 3KNC (G.P.O.) 1956-59; Series III Tanker 1957-60; Series IVFF Tanker 1958-60.
Rover 'Landrover' (G.P.O.) 1954-56.
- 53297 469 Number plate illumination and reverse lamp. C.P. finish; overall dimensions $6\frac{1}{8} \times 1\frac{1}{8}$ "; 12v.; three single contact bulb holders; two-stud fixing.
Bentley 'Continental' Sports 1953-54.
- 53304 533 Stop tail and number plate lamp. C.P.R., 4" dia.; 12v.; three double contact bulb holders; red lens; two-stud fixing; as 53295 except for bulbs.
Rover 'Landrover' (G.P.O.) 1957-60.
- 53305 542 Stop tail lamp. Red diakon lens, lower half reflex; 12v.; double contact; flush fitting.
A.C. Cars 'Ace' Sports 1955-60.
Hillman 'Minx' All Models 1954-55; 'Minx Special' 1956.
Jensen '541' and '541R' 1956-60.
- 53306 461-1 Stop and flasher lamp. C.P.R., $2\frac{1}{2}$ " dia.; 12v.; double contact; amber lens; flush fitting.
Bentley 'Continental' Sports 1953-54.
- 53307 461 Reverse lamp. C.P.R., $2\frac{1}{2}$ " dia.; 12v.; single contact; clear lens; flush fitting.
Bentley 'Continental' Sports 1953-54.
- 53308 543 Number plate illumination and boot lamp. C.P. finish; 12v.; two single contact bulb holders; two-stud fixing.
Citroen 15 1954-55; 25 1955.
- 53310 546 Stop tail and reflex lamp. C.P.R.; overall dimensions $5\frac{1}{8} \times 3\frac{1}{8}$ "; 12v.; double contact; flush fitting; left hand lamp for right hand drive.
Morris 'Cowley', 'Oxford' and 'Hindustan' 1955-56; 'Isis' (when trafficators fitted) 1956.
- 53311 546 Stop tail and reflex lamp. Right hand lamp for right hand drive; otherwise as 53310.
Morris 'Cowley', 'Oxford' and 'Hindustan' 1955-56; 'Isis' (when trafficators fitted) 1956.
- 53312 546 Stop tail, flasher and reflex lamp. Left hand lamp for left hand drive; otherwise as 53310.
Morris 'Cowley', 'Oxford' and 'Hindustan' 1955-56; 'Isis' and 'Traveller' 1956.
- 53313 546 Stop tail, flasher and reflex lamp. Right hand lamp for left hand drive; otherwise as 53310.
Morris 'Cowley', 'Oxford' and 'Hindustan' 1955-56; 'Isis' and 'Traveller' 1956.
- 53315 488 Stop tail and rear flasher lamp. C.P.R.; $2\frac{3}{8}$ " dia.; 12v.; single contact; ruby lens; flexible body; flush fitting.
Wolseley 'Six-Ninety' 1955-56.
- 53317 469 Number plate illumination and reverse lamp. Black finish; overall dimensions $6\frac{1}{8} \times 1\frac{1}{8}$ "; 12v.; three single contact bulb holders; two-stud fixing.
M.G. 'Magnetite' 1954-59.
- 53318 471 Stop tail lamp. Special C.P.R.; 12v.; double contact; red glass, cheesedish type; flush fitting.
Triumph 2-seater Sports 1954.
- 53320 467 Number plate illumination lamp. Black finish; overall dimensions $4\frac{1}{8} \times 1\frac{1}{8}$ "; 12v.; one single contact bulb holder; two-stud fixing.
Standard 'Eight' 1954-55; 6 cwt. Van (Export Holland and Belgium) 1956-59.
- 53330 549 Stop tail and reflex lamp. C.P.R.; 12v.; double contact; red lens, with reflex; two-screw fixing.
A.C. Cars 16 1956-57; 'Aceca' 1955-60.
Aston Martin DB Mk. IIIA 1958.
Austin-Healey 'Sprite' 1958-60.
Elva 'Courier' (B.M.C. 1,500 c.c. engine) 1959-60.
Fairthorpe 'Electron' and 'Electron Major' 1958-60; 'Atomota' and 'Zeta' 1959-60.
Jaguar XK-SS Open 2-seater (Export U.S.A. only) 1958.
Lagonda 3 litre 1955-58.
Lotus Mk. VII and Mk. VIII (Ford 100E engine) 1958.
M.G. MGA and MGA 1600 1956-60.
Morgan 'Plus Four' and 'Four Four' Series II (Ford Engine) 1959-60.
Morris 'Minor' 1955-56.
Riley 1½ litre (later) 1955.
Singer 'Hunter' 1956.
Triumph TR2 1955-57; TR3 (Export Holland) 1957; TR3 1958-60.

REAR LAMPS



VEHICLE APPLICATION REFERENCE—continued

53332 551 Stop tail and reflex lamp. Sunken C.P.R., 4½" dia.; 12v.; double contact; red lens, with reflex; flush fitting.

Austin A40, A50, A90 and A95 1955.

53339 553 Stop tail, flasher and reflex lamp. Diecast rim and base; 12v.; one single contact and one double contact bulb holder; pale amber outer lens and red reflex; red cover over lower bulbs; four-stud fixing. Bentley Model 'S' and Sports Saloon 1955-59; 'Continental' 1960.

Rolls-Royce 'Silver Wraith' (James Young) and 'Silver Cloud' 1956-59; 'Silver Cloud' II and 'Phantom' V 1960.

53340 549 Stop tail and reflex lamp. C.P.R.; 12v.; double contact; red lens, with reflex; two-screw fixing; left hand lamp.

Jaguar 3½ litre Mk. VII 1955-58; Mk. VIII 1957-58; Mk. IX 1959.

53341 549 Stop tail and reflex lamp. As 53340 except for rim and bulb holder; right hand lamp.

Jaguar 3½ litre Mk. VII 1955-58; Mk. VIII 1957-58; Mk. IX 1959.

53343 554 Number plate illumination lamp. Black finish; 12v.; double contact; clear, domed window; rubber seating; two-screw fixing.

Austin A35 Pick-up Truck 1957-58.
Commer 25 cwt. Forward Control and 25 cwt. 'Superpoise' Van 1955-56; 1½/1¼ ton Forward Control and 1½/1¼ ton 'Superpoise' Van and Medium Pick-up Truck Mk. V 1956-60; 2½ ton (Petrol) and 3½ ton (Diesel) 'Superpoise' and Fire Tender or Pump Chassis 1955-60; 6 ton 'Superpoise' 1959-60; 4, 5 and 6 ton Forward Control 1959-60; 7 ton Forward Control 1955-60; 5 ton Forward Control 1955-58; 10/12 ton Tractor (Rootes TS3 Diesel engine) 1957-60.
Karrier 'Bantam' and 'Gamecock' 1955-60; 1½/1¼ ton Passenger Chassis 1957-60.

53346 554 Number plate illumination lamp. As 53343, but 24 volt.

Commer 5 ton 'Superpoise' and 6 ton (Diesel, 24 volt) 1955-60.

53350 549 Stop tail and reflex lamp. C.P.R.; 12v.; double contact; red lens; two-screw fixing; left hand lamp.

Jaguar XK140 1955-57; XK150 1958-59.

53351 549 Stop tail and reflex lamp. As 53350 except for rim and bulb holder; right hand lamp.

Jaguar XK140 1955-57; XK150 1958-59.

53356 558 Stop tail, flasher and reflex lamp. C.P.R.; 12v.; one single contact and one double contact bulb holder; amber and red lens, oblong shape; flush fitting.

Alvis 3 litre TG and 108G Saloon (Grabber body) 1956-57.
Armstrong Siddeley 'Star Sapphire' and Limousine 1959-60.
Austin 152 Range, Half Ton Van and Pick-up Truck and '12 Range 1957-60.
Rover '60', '90' and '105' 1955-59; '80' and '100' 1960.

53358 556 Rear flasher lamp. 4½" dia.; amber lens, lightly stippled; single contact; flexible body; flush fitting.

Morris Commercial 2/3, 4 and 5 ton Truck, Coach and Tanker (when fitted) and Prime Mover Series III 1959-60; Series IVFG Forward Control Trucks 1960; 7 ton Truck, Coach and Prime Mover Series IVFF 1958-60.
Smiths Delivery Vehicles 'Mobile Shop' 1956-58.

53359 488 Rear flasher lamp. C.P.R., 2½" dia.; 12v.; single contact; amber lens; flexible body; flush fitting; as 53210 except for lens.

Singer 'Hunter' 1955-56.
Trojan 20 and 25 cwt. Vans 1959-60.
Wolseley 'Six Ninety' (L.H.D. and optional R.H.D.) 1955-56.

53362 559 Roof flasher lamp. Amber, half-moon shaped lens; single contact; pressed metal base for fitting to door pillar.

Morris Commercial LD Models 1956-60.

53367 556 Rear flasher lamp. 4½" dia.; amber lens, lightly stippled; double contact; flexible body; flush fitting; as 53358 except for bulb holder and bulb.

Morris Commercial LCFO (when fitted) 1958-59 and 1960.

53374 467-2 Number plate illumination lamp. Black finish; overall dimensions 4 5/8" x 1 3/8"; 12v.; one single contact bulb holder; two-stud fixing.

Smiths Delivery Vehicles Standard Drive Models (Electric) 1953-55; 14, 20 and 30 cwt. (Electric) 1956-58; 1 and 2 ton (Diesel) and 'Mobile Shop' (Electric) 1954-55.

53376 465 Number plate illumination and reverse lamp. C.P. finish; overall dimensions 17" x 1 1/4"; 12v.; six single contact bulbs; 'Sunbeam' on reverse window; two-screw fixing.

Sunbeam 'Alpine' Saloon Mk. III 1955-57.

53377 551 Stop tail and reflex lamp. C.P.R., 3 3/4" dia.; double contact; red lens, with reflex; flush fitting.

Bond 'Minicar' 1958-60.
Bristol '405' and '406' 1955-60.
Daimler 4½ litre Limousine 1957-59; 'Majestic' 1959-60.

Frazer Nash 'Mille Miglia', 'Targo Florio' and 'Sebring' Hard Top 1955.

Isetta (Great Britain) '300' (Export Canada) 1958-60.

Jensen 'Tempo 1500' 1958-60.
Layton Sports Car 'Jomar' (T.V.R.) 1959-60.
M.G. 'Magnette' 1955-59.

53378 539 Reverse lamp. C.P.R., 3 3/8" dia.; 12v.; single contact; clear lens; flush fitting.

Citroen DS19, ID19 and 'Safari' 1960.
Daimler 'Conquest' Roadster 1955; Drophead Coupé 1956-57; 'Empress' Saloon, 'Regency' (and 'Sportsman') and 'Regina' Limousine 1955; 3½ litre 'One-O-Four' Saloon 1956-59; 4½ litre Limousine 1956-60; 'Majestic' 1959-60.

53381 549 Stop tail and reflex lamp. C.P.R.; 12v.; double contact; red lens, with reflex; two-screw fixing; left hand lamp.

Jaguar 2.4 litre 1956-59.

53382 549 Stop tail and reflex lamp. As 53381, but right hand lamp.

Jaguar 2.4 litre 1956-59.

53384 551 Stop tail and reflex lamp. C.P.R., 3 3/4" dia.; 12v.; double contact; red lens with reflex; 38½" cable; flush fitting.

Austin A135 'Princess' and Limousine 1955-60.

53388 467-2 Number plate illumination lamp. C.P. finish; overall dimensions 4 5/8" x 1 3/8"; 12v.; one single contact bulb holder; as 53093, but less fixing studs, washers and nuts.

Standard 'Eight' and 'Ten' 1956-59.

53390 ST51 Stop tail and number plate lamp. Black finish; 12v.; double contact; red lens; two-stud fixing.

Armstrong Siddeley 'Typhoon' 1948-50; Utility 1950-52.
Austin 8 Van and 10 1946-47; A40 Van, 'Countryman' and Pick-up Truck 1948-55; A70 'Countryman' and Pick-up Truck 1952-54; Taxi (Petrol) 1948-54; 25 cwt. Van 1949-54.

Commer 8 cwt. Van 1947-48.
Hillman 'Minx' Estate Car 1948; 'Minx' 1947-48.
Jowett 10 cwt. 'Bradford' Van 1946-52; 6 Light Utility 1949-52.

Morris 8 and 10 1946-48; 'Oxford' Saloon 1948-49; 5 cwt. Van (later) 1947-53; 10 cwt. Van 1950.
Rover 'Landrover' 1948-50; 'Landrover' (except N.A.D.A.) 1951-54.
Singer 9 Roadster 1946-51.
Standard 12 and 14 Coupé (Export Holland) 1946.

53392 ST51 Stop tail and number plate lamp. C.P. finish; 12v.; double contact; red lens; two-stud fixing.

Allard 16 4-seater 1947-49; 'L' Model 1949-51.
Austin 25 cwt. Van and Ambulance 1948; Ambulance 1949-54.
Citroen 23 1949-50.
Humber 'Hawk' 1946-48; 'Imperial' and 'Pullman' 1946-47; 'Snipe' and 'Super Snipe' 1946.
Jowett De Luxe Van 1949-52.
Lloyd '650' Roadster (Export) 1948-50.
M.G. 1½ litre 1947-53; 'Midget', MGA and MGA 1600 1949-60.
Morris 'Minor' 2-door 1948-49.
Riley 1½ litre 1946-55; 2½ litre 1947-53.
Rover 10, 12, 14 and 16 1946-47; Station Wagon 1949.

Singer 10 1946-49.
Standard 8 1946-48; 14 (Export Australia) 1946.
Sunbeam-Talbot 2 litre 1946-47.
Trojan 15/20 cwt. Van (Petrol) 1946-54; 15/20 cwt. Van and Truck (Diesel) 1954.
Wolseley 8 1946-48.

53394 564 Stop tail, reflex and number plate illumination lamp. 6v.; double contact; red lens; two-screw fixing.

A.C. Cars Invalid Carriage 1952-53.
Barrett, W. & F. 'Midget' All-weather Invalid Car 1954; 147 c.c. All-weather Invalid Car 1953-54; 197 c.c. All-weather Invalid Car 1955.

53397 488 Tail lamp. C.P.R., 2 3/8" dia.; 12v.; single contact; red lens; rubber body; flush fitting.

Commer 3 ton four-wheel drive Cross Country Vehicle 1956.
Isetta (Great Britain) '300' 1960.
Wolseley 'Six Ninety' 1955-56.

53405 518-2 Stop tail lamp. Black body incorporating red lens; 12v.; double contact; two-screw fixing.

Rover 'Landrover' 1955-56.

53407 570 Stop tail and flasher lamp. C.P.R., 7" dia.; 12v.; one single contact and one double contact bulb holder; circular red lens, with amber inset for flasher.

Standard 'Vanguard' Saloon 1956-57; Estate Car and Saloon (Export Australia) 1958.

53410 571 Stop tail, flasher and reflex lamp. C.P.R.; overall dimensions 5 5/8" x 2 3/8"; 12v.; double contact; red lens; flush fitting.

Armstrong Siddeley 'Sapphire' (later) 1955; 'Sapphire 346' Saloon 1956-59.
Daimler 'Conquest' ('Century') 1956-58.
Lanchester 'Sprite' 1955-56.

53412 464 Reverse lamp. C.P.R.; overall dimensions 4 3/4" x 2 1/4"; 12v.; single contact; clear, fluted lens; rubber grommet; flush fitting.

Austin 'Princess' and Limousine 1956-60.

53414 469 Number plate illumination and reverse lamp. C.P. finish; overall dimensions 6 5/8" x 1 1/8"; 12v.; three single contact bulb holders; 'Wolseley' on lens; two-stud fixing.

Wolseley 'Six Ninety' 1955-59.

53426 525 Stop tail and number plate illumination lamp. Red lens, with clear lens insert for number plate; 12v.; double contact; less fixing screws, nuts and washers.

Isetta (Great Britain) '300' (Export Canada) 1958-60.
Standard 'Eight' De Luxe and 'Ten' 1955; 'Eight', 'Ten', 'Companion' Estate Car and 6 cwt. Van 1956-59.

53432 564 Stop tail, reflex and number plate illumination lamp. Red lens, with clear lens insert for number plate; 6v.; double contact; two-screw fixing.

Reliant 'Regal' Car 1955-58; 5 cwt. Van 1959; 6 cwt. Van and Truck 1955.
Tippen Invalid Carriage 1955-56.

53439 ST38E Stop tail and number plate illumination lamp. Black finish; 3 3/8" rim dia.; 6v.; two single contact bulb holders; red lens; two-screw fixing.

Lloyd '650' Roadster 1948-50.

53440 ST38E Stop tail and number plate illumination lamp. Black finish; 3 3/8" rim dia.; 12v.; two single contact bulb holders; red lens; two-screw fixing.

Austin 2 and 5 ton Trucks 1949-52; Coach 1947-55.
Bedford 5/6 cwt. Van 1946-47; 10/12 cwt. Van 1946-52.

Citroen 15 1946-52; 23 1951-52.
Commer 15/25 cwt. 1946-48; 25 cwt. Forward Control, 2/3 ton and 3/4 ton 1949-54; 25 cwt. 'Superpoise' Van 1950-54; 4/5 ton 1949-51; 5 ton 'Superpoise' 1952-54; 'Commando' (Petrol) 1950-53; 3 and 4 ton Trucks, Pantechicon and 'Commando' (Petrol) 1947-49; 3 and 4 ton Trucks, Tipper Chassis (Diesel), Pantechicon and 'Commando' 1947; 5 ton 'Superpoise' (Diesel) 1950-54; 5 ton 1947; 5 ton 'Superpoise' 1954; 5 and 7 ton 1949; 6½ and 7 ton 1949-50; 8 ton Tractor Trailer 1950; 'Avenger' Coach (Diesel engine, 24 volt) 1954; Fire Tender or Pump Chassis 1952-54.
Karrier 'Bantam' 1951-54; CK3 3 ton 1947-52; 'Gamecock' 1953-54.

Morris 5 cwt. Van 1947; 10 cwt. Van 1946-49.
Morris Commercial 15/20 cwt. (PV) 1950-52; 25/30 cwt. (LC3) 1946-52; 25/35 cwt. 1946; 35/40, 45/55 and 60/70 cwt., 5 ton Forward Control, Tipper, ECV13/3, CEV13/5, CV11/30, CV10 Tipper and CV11/40 Lorries 1946-48; CV9/40 Tippers 1950-51; ECV13/5 (Petrol) and ECV10/3/5 (Diesel) 1949; PV and FVO 1949-53; NVO and NVS 1953; FF Coach 1950-52.
Smiths Delivery Vehicles 'Mobile Shop' (Electric) 1953-55.
Vauxhall 10 and 12 1946-47.



REAR LAMPS

VEHICLE APPLICATION REFERENCE—continued

- 53443 ST38E Stop tail and number plate illumination lamp. Black finish; 3 $\frac{1}{8}$ " rim dia.; 12v.; two double contact bulb holders; red lens; two-screw fixing. Wales & Edwards 1 ton Electric Van 1953-55.
- 53444 572 Stop tail lamp. C.P.R.; 12v.; double contact; all red lens; flush fitting; two-screw fixing. Hillman 'Minx' 1957; 'Minx' (Export North America) 1958; 'Minx Special' (Export U.S.A.) 1958. Singer 'Gazelle' (Export North America) 1957-58.
- 53452 574 Number plate illumination and reverse lamp. C.P.R.; 2 $\frac{3}{8}$ " dia.; 12v.; red primer body; two single contact bulb holders; clear lens. Standard 'Vanguard' Phase III Saloon 1956-60.
- 53453 512 Number plate illumination and reverse lamp. C.P. diecast body; 12v.; three single contact bulb holders; clear lens marked 'Jaguar'; as 53557 except for lens. Jaguar 2.4 litre 1956-59; Mk. II 1960.
- 53454 564 Stop tail, reflex and number plate illumination lamp. Red lens, with clear lens insert for number plate; 12v.; double contact; two-screw fixing; as 53432 except for voltage. Reliant 'Regal' Car 1959; 10 cwt. (later) 'Regent' 3-wheeler Van 1955-56.
- 53459 DC43 Stop tail and number plate illumination lamp. Black finish; 4" rim dia.; Lucas medallion on body; 12v.; double contact; two interior bulb holders; two-stud fixing. Douglas Battery Vehicle 1950. Morrison Electricars Battery Vehicle 1951-54.
- 53460 538 Stop tail lamp. C.P.R.; 3 $\frac{1}{8}$ " dia.; 12v. double contact; red lens, lightly stippled; flush fitting. Rolls-Royce 'Silver Wraith' (except James Young) 1956-59.
- 53464 548 Stop tail, reflex and reverse lamp. C.P.R.; 12v.; one double contact and one single contact bulb holder; red lens and clear reverse lens; flush fitting. Humber 'Hawk' 1955-57.
- 53465 572 Stop tail, reflex and reverse lamp. C.P.R.; 12v.; one double contact and one single contact bulb holder; red lens, with clear lower lens for reverse; flush fitting; two-screw fixing. Sunbeam 'Rapier' 1956-57.
- 53481 528 Number plate illumination and reverse lamp. C.P. finish; diecast outer cover; three single contact bulb holders; amber lens; three-stud fixing. Bentley Model 'S' Sports Saloon (Export France) 1955-56; 'Continental' (Export France) 1957-59.
- 53489 583 Stop tail, flasher and reflex lamp. C.P.R.; 12v.; one double contact and one single contact bulb holder; red stop tail lens and amber flasher lens; three-screw fixing. Armstrong Siddeley 'Sapphire 234' and 'Sapphire 236' 1956-58.
- 53495 553 Stop tail and flasher lamp. Diecast rim and base; 12v.; one double contact and one single contact bulb holder; pale amber lens, with reflex; two-stud fixing. Bentley Model 'S' and 'Continental' Sports (Export France) 1957-59; 'Continental' (Export France) 1960. Rolls-Royce 'Silver Wraith' (James Young) and 'Silver Cloud' (Export France) 1956-59; 'Silver Cloud' II and 'Phantom' V (Export France) 1960.
- 53501 539 Reverse lamp. C.P.R.; 3 $\frac{1}{8}$ " dia.; 12v.; single contact; red lens; 1 $\frac{1}{2}$ " rubber sleeve; flush fitting. Bentley Model 'S' and 'Continental' Sports (Export Italy) 1957-59. Rolls-Royce 'Silver Wraith' (Park Ward, Export Italy) 1956-59.
- 53502 524 Number plate illumination lamp. Frost white cover; 12v.; single contact; clear, domed glass; flush fitting. Austin 'Metropolitan' 1957-60. Nash 'Metropolitan' 1954-60.
- 53504 488 Flasher lamp. C.P.R.; 2 $\frac{3}{8}$ " dia.; 12v.; single contact; amber lens; flexible body; flush fitting. Smiths Delivery Vehicles Standard Drive Models (Electric, special orders) 1955; 14, 20 and 30 cwt. (Electric, special orders) 1956-58; 1 ton (Diesel, special orders) 1953-55; 'Mobile Shop' (Electric) 1955. Standard 'Eight' and 'Ten' Saloons (Export Holland and Belgium) 1956-57. Triumph TR3 (Export Holland) 1957.
- 53515 461-1 Reverse lamp. Clear window rolled into C.P.R.; 12v.; single contact; flush fitting. Bentley 'Continental' (Mulliner Body) 1957-59.
- 53516 553 Stop tail, flasher and reflex lamp. Diecast rim and base; 12v.; one double contact and one single contact bulb holder; red lens, with reflex; four-stud fixing. Bentley Model 'S' and 'Continental' Sports (Export California) 1957-59; 'Continental' (Export U.S.A.) 1960. Rolls-Royce 'Silver Wraith' (James Young) and 'Silver Cloud' (California) 1956-59. 'Silver Cloud' II and 'Phantom' V (Export U.S.A.) 1960.
- 53518 534 Number plate illumination lamp. C.P. cover; 12v.; single contact; clear, domed window; flush fitting. Austin A40 1955-56; A50 (later) 1956-57; A40 1960; A90 and A95 1955-56; A90, A95 'Countryman' and A105 (BS7) 1957. Bristol '406' 1958-60. Citroen 'DS19, 1D19 and 'Safari' 1960. Cooper 'Monaco' Sports (Coventry Climax engine) 1959-60. Humber New 'Hawk' Estate Car 1958-59. Lotus Mk. VII and Mk. VIII (Ford 100E engine) 1958. Wolsley 'Six Ninety-Nine' 1959-60.
- 53520 581 Stop tail and reflex lamp. Red lens, with reflex; 3 $\frac{1}{2}$ " rim dia.; metal backplate with staked lens fixing screw; 12v.; double contact; flush fitting. Austin 10 cwt. 'Gipsy' 1958-60. Frisky Saloon 1958; Coupé 1959; 'Family Three' 1960. Reliant 'Regal' Car and 5 cwt. Van 1960. Standard 'Atlas', 10/12 cwt. Van and Pick-up Truck 1959-60. Trojan 20 and 25 cwt. Van, Truck and Bus 1959-60.
- 53522 553 Stop tail, flasher and reflex lamp. Diecast rim and base; 12v.; one single contact and one double contact bulb holder; deep amber lens, with red reflex; red cover over lower bulb; four-stud fixing. Bentley Model 'S' and 'Continental' Sports (Export U.S.A.) 1957-59. Rolls-Royce 'Silver Wraith' (James Young) and 'Silver Cloud' (Export U.S.A.) 1956-59.
- 53527 548 Stop tail, flasher and reflex lamp. C.P. body; 12v.; one double contact and one single contact bulb holder; amber lens at top, red lens at bottom and red reflex; flush fitting. Alvis TD21 1958-60. Aston Martin DB Mk. IIIB 1958-59; DB4 and DB4GT 1959-60. Peerless 'Gran Turismo' 1959-60.
- 53539 572 Stop tail, flasher and reflex lamp. C.P. peaked diecast base; 12v.; one double contact and one single contact bulb holder; amber flasher lens and red stop tail lens; two-stud fixing. Hillman 'Minx' 1959; 'Minx' De Luxe 1959-60. Sunbeam 'Rapier' 1957.
- 53540 572 Stop tail, flasher and reflex lamp. C.P. metal base; 12v.; one double contact and one single contact bulb holder; amber flasher lens and red stop tail lens; two-stud fixing. Commer 'Cob' Series II 1960. Hillman 'Minx' (amber, later) 1957-58; 'Minx Special' (except North America) 1958-59. Singer 'Gazelle' (except North America) 1957-59. Sunbeam 'Rapier' 1958.
- 53541 523 Stop tail and flasher lamp. Oval shaped red lens, with reflex; 12v.; one double contact and one single contact bulb holder; flush fitting; as 53280, but less plastic rim. Alfa Romeo 'Giulietta' (Sports, 750C 'Berlina'), (Sprint, 750B) and (L.I. 753) 1957-60; 'Giulietta Spyder' 1956-59; T10 Van (Petrol) 1958-59. Austin 'Metropolitan' 1957-60. Nash 'Metropolitan' 1957.
- 53546 574 Number plate illumination and reverse lamp. C.P. diecast body; C.P.R.; 2 $\frac{3}{8}$ " dia.; 12v.; two single contact bulb holders; clear lens. Standard 'Vanguard Sportsman' 1957-58.
- 53547 587 Stop tail, flasher and reflex lamp. C.P. peaked rim; 12v.; one double contact and one single contact bulb holder; amber flasher lens and red stop tail lens; flush fitting. Humber New 'Hawk' 1958-60; New 'Super Snipe' 1959-60.
- 53551 469 Number plate illumination and reverse lamp. C.P. finish; overall dimensions 6 $\frac{1}{2}$ " x 1 $\frac{1}{2}$ "; 12v.; three single contact bulb holders; yellow lens; two-stud fixing. Jaguar XK140 (Export France) 1957.
- 53553 589 Stop tail, flasher and reflex lamp. Amber and red lens, with reflex; 12v.; one double contact and one single contact bulb holder; left hand lamp. Vauxhall 'Wyvern', 'Velox', 'Cresta', 'Grosvenor' Estate Car and 'Dormobile' 1957.
- 53554 589 Stop tail, flasher and reflex lamp. Amber and red lens, with reflex; 12v.; one double contact and one single contact bulb holder; right hand lamp; as 53553 except for lens. Vauxhall 'Wyvern', 'Velox', 'Cresta', 'Grosvenor' Estate Car and 'Dormobile' 1957.
- 53556 512 Number plate illumination and reverse lamp. C.P. diecast body; 12v.; four single contact bulb holders; yellow lens, marked 'Jaguar'; two-stud fixing; as 53215 except for lens (Export France). Jaguar 3 $\frac{1}{2}$ litre Mk. VII 1957-58; Mk. VIII 1957-59; Mk. IX 1959-60; XK150 1958-60.
- 53557 512 Number plate illumination and reverse lamp. C.P. diecast body; 12v.; three single contact bulb holders; yellow lens, marked 'Jaguar'; as 53453 except for lens (Export France). Jaguar 2.4 litre 1956-59; Mk. II 1960.
- 53558 574 Number plate illumination and reverse lamp. C.P. diecast body; C.P.R.; 2 $\frac{3}{8}$ " dia.; 12v.; two single contact bulb holders; yellow reverse light lens; as 53452 except for reverse light lens. Standard 'Vanguard' Saloon Phase III (Export France) 1957-60.
- 53564 594 Stop tail lamp. C.P.R.; 2 $\frac{3}{8}$ " dia.; 12v.; double contact; red lens; flexible body; flush fitting. Austin A35 Saloon and Pick-up 1957-59; A55 Pick-up Truck and Van 1958-60; Series IVFG Trucks 1960; Austin-Healey '100 Six' 1957-59; Austin Healey '3000' 1959-60. Berkeley Sports Car (700 c.c. Enfield engine) 1959-60. Bedford CA Van (Export Canada) 1959-60. Standard 'Eight' and 'Ten' Saloons (Export Holland and Belgium) 1958-59; (Home) 1956-60. Tornado 'Typhoon' 1959-60.
- 53565 593 Stop tail, flasher and reflex lamp. C.P.R.; 12v.; one double contact and one single contact bulb holder; amber flasher lens and red stop tail lens, with reflex; flush fitting. Austin A55 1958-59; A90, A95, 'Countryman' and A105 (BS7) 1957-59.
- 53566 551 Stop tail and reflex lamp. C.P.R.; 3 $\frac{1}{2}$ " dia.; 12v.; double contact; red lens, with reflex; flush fitting. Austin 'Princess' and Limousine 1957-59.
- 53574 518-2 Stop tail and number plate illumination lamp. Black body, incorporating red stop tail lens and clear number plate lens; 12v.; double contact; two-screw fixing. Rover 'Landrover' 1955-57.
- 53576 549 Stop tail and reflex lamp. C.P.R.; 12v.; double contact; red lens, with reflex; two-screw fixing; right hand lamp. Morris 'Minor 1000' 1957-60.
- 53577 549 Stop tail and reflex lamp. C.P.R.; 12v.; double contact; red lens, with reflex; two-screw fixing; left hand lamp. Morris 'Minor 1000' 1957-60.
- 53578 ST38E Stop tail and number plate illumination lamp. Black finish; 3 $\frac{1}{8}$ " rim dia.; 12v.; two single contact bulb holders; red stop tail lens and clear number plate lens; two-stud fixing. Commer 3 and 4 ton Tipper (Petrol) 1947-49. Vauxhall 14 1946-48.
- 53579 593 Stop tail, flasher and reflex lamp. C.P.R.; 12v.; one double contact and one single contact bulb holder; red lens, with reflex; flush fitting. Austin A55 and A105 (Vanden Plas) BS8 (Export North America) 1958-59; A105 (BS7) (Export North America) 1957-59.

REAR LAMPS

VEHICLE APPLICATION REFERENCE—continued

53580 288 Number plate box. Black finish; C.P.R.; double filament bulbs; 12v.; partition cut back; plain window with two 'D' shaped red glasses; four-stud fixing.

Allard 16 2-seater 1947-49; 'K' Model 1949-51. Alvis 14 1946-50.
Armstrong Siddeley 'Hurricane' 1946-53.
Daimler 27 and 36 1946-53; 2½ litre Model (except 'Consort') 1946-47.
H.R.G. 12 'Streamline' 1946.
Jaguar 1½ litre 1946-47.
Jensen 3½ litre 1946-47.
Lanchester 10 LD10 1946-48.
Lea Francis 14 1946-50; 14 Estate Car 1953-54.
Morris 'Oxford' Taxi and Hire Car 1947-49.
Singer 12 1947-49.
Triumph '1800' 1946-48; '2000' 1949.
Wolseley 10 and 12 1946-47; 14 and 18 1946-48.

53582 288 Number plate box. Black finish; C.P.R.; 12v.; similar to 53580, but square end cover; less studs.

Triumph '1800', 18T and 18TR Saloon 1946-48; '2000' Saloon 1949; 'Renown' 1950-54.

53583 288 Number plate box. Black finish; C.P.R.; 12v.; similar to 53580, but six-stud fixing.

Standard 12 and 14 1946-48.

53584 288 Number plate box. Black finish; C.P.R.; 12v.; similar to 53580.

Lea Francis 18 4 Light Saloon 1951.
Morris 'Oxford' Taxi and Hire Car 1950.
Wolseley 10 and 25 1948; 12 1946-48.

53585 285 Number plate illumination lamp. C.P.R.; 12v.; four bulbs; single contact; flush fitting; less box.

Jaguar 1½ litre (special equipment) 1946-47 and (later) 1947-48; 2½ and 3½ litre 1946-48.

53586 596 Stop tail, flasher and reflex lamp. C.P.R.; 12v.; one double contact and one single contact bulb holder; amber lens at top, reflex in middle and stop tail lens at bottom; flush fitting.

Wolseley 'Fifteen Hundred' 1958-60.

53587 596 Stop tail, flasher and reflex lamp. As 53586 except for flasher lens, which is red.

Wolseley 'Fifteen Hundred' (Export U.S.A. and Canada) 1958-60.

53588 597 Stop tail and flasher lamp. C.P.R., oval shaped; 12v.; one double contact and one single contact bulb holder; flasher body and amber lens at top, stop tail and reflex body with red lens at bottom; flush fitting; as 53590 except for flasher lens.

Morris 'Cowley' 1957-59; 'Oxford', 'Traveller' and 'Hindustan' (except U.S.A.) 1957-60; 'Isis' and 'Traveller' (except U.S.A.) 1957-58.

53589 597 Stop tail and flasher lamp. C.P.R., oval shaped; 12v.; two single contact bulb holders; tail lamp body and red lens at top, stop and flasher body with red lens at bottom; flush fitting.

Morris 'Cowley' Saloon (when trafficators fitted) and 'Oxford' (when trafficators fitted) 1957; 'Traveller' and 'Hindustan' (when trafficators fitted) (later) 1958-60; 'Isis' Saloon (when trafficators fitted) 1957-58.

53590 597 Stop tail and flasher lamp. C.P.R., oval shaped; 12v.; one double contact and one single contact bulb holder; flasher body and red lens at top, stop tail and reflex body with red lens at bottom; flush fitting; as 53588 except for flasher lens.

Morris 'Cowley' Saloon, 'Traveller' and 'Hindustan' (Export U.S.A.) 1957-59; 'Traveller' and 'Hindustan' (Export U.S.A.) 1957-60; 'Isis' and 'Traveller' (Export U.S.A.) 1957-58.

53594 ST54 Stop tail lamp. C.P.R., half-moon shaped; 12v.; two single contact bulb holders; red lens; less body, for fitting into recessed panel.

Austin 12 and 16 1946-48.

53595 599 Number plate illumination lamp. C.P. cover; overall dimensions 10½" × 1¼"; 12v.; two single contact bulb holders; clear lens; rubber base; two cover fixing screws.

Vauxhall 'Velox', 'Cresta' and 'Friary' Estate Car 1958-60.

53596 600 Stop tail, flasher and reflex lamp. C.P.R., riveted to base; 12v.; one double contact and one single contact bulb holder; red lens, with amber sub-lens let in near top, and between them a rectangular reflex; flush fitting.

Standard 'Pennant' 1958-59.

53599 601 Stop tail and reflex lamp. Red, oblong lens, with clear lens cemented behind it and red reflex lower half of lens; 12v.; double contact; four-screw fixing.

Vauxhall 'Victor' 1958-60; 'Envoy' Station Wagon (Export Canada only) 1960.

53600 594 Rear flasher lamp. C.P.R., 2 3/8" dia.; 12v.; single contact; flexible body; flush fitting.

Austin A35 (Export North America) 1957-60; Taxi (Diesel) and Hire Car (Export U.S.A.) 1960; 10 cwt. 'Gipsy' (Export North America) 1959-60; Austin-Healey 'Sprite' (Export North America) 1958-60.
Bedford CA Van (Export North America) 1959-60.
Citroen 'Safari' 1960.
Elva 'Courier' (B.M.C. 1,500 c.c. engine, Export U.S.A.) 1959-60.

Layton Sports Cars 'Jomar' (T.V.R.) (Export U.S.A.) 1959-60.
Lotus Mk. IX (Coventry Climax or M.G. engine) (Export U.S.A.) 1958-59.

Morgan 'Plus Four' (Export U.S.A.) 1960; 'Four Four' Series II (Ford engine) (Export U.S.A.) 1960.
Standard 'Eight' and 'Ten' (Export N.A.D.A.) 1958-60.
Triumph TR3 (Export N.A.D.A.) 1958-60.

53603 528 Number plate illumination and reverse lamp. Corom, diecast cover; 12v.; three single contact bulb holders; clear lens; three-stud fixing; as 53604 except for lens.

Bentley 'Continental' Sports Saloon 1955-56; Model 'S' 1957-59; Model 'S2' 1960.
Rolls-Royce 'Silver Cloud' 1956-59; 'Silver Cloud' II II and 'Phantom' V 1960.

53604 528 Number plate illumination and reverse lamp. Yellow lens; as 53603 except for lens.

Bentley 'S' Model (Export France) 1957-59.
Rolls-Royce 'Silver Cloud' (Export France) 1956-59.

53606 469 Number plate illumination and reverse lamp. C.P. finish; overall dimensions 6 3/8" × 1 1/4"; three single contact bulb holders; amber reverse light lens; two-stud fixing.

Standard 'Vanguard' Phase III Saloon (Export France) 1957-60.

53608 518-2 Stop tail lamp. Black body, incorporating red lens; 12v.; double contact; two-screw fixing.

Rover 'Landrover' 1957.

53616 582 Tail and number plate lamp. Black body; 12v.; double contact; red lens; plastic window; centre spigot fixing.

Austin 2½ ton Petrol Tanker 1946-55.
Diamond Motors Pedestrian Controlled Battery Vehicle 1951-56.

Douglas 15/20/25 cwt. Electric Vehicles 1949; Battery Vehicle 1950-54.
Leonard Gundle 'Handy Motor' 3-wheel Delivery Van 1951-52.

Harborough Construction Battery Vehicle (12 volt) 1951-54.
Hindle Smart Battery Vehicle 1951-54.
Lewis, H. T. Pedestrian Controlled Battery Vehicle 1951-55.

Midland Vehicles Battery Vehicle 1951-55.
Morrison Electricars Battery Vehicle 1951-54.
Victor Electric Battery Vehicle 1952-55.

53624 538 Stop tail lamp. C.P.R., 3 1/8" dia.; 12v.; double contact; red lens; flush fitting; less cables and tubing.

Daimler 'Conquest' Roadster 1954-55; 'Conquest' Coupé 1956-57; 'Empress' Saloon, 'Regency' (and 'Sportsman') and 'Regina' Limousine 1955; 3½ litre 'One-O-Four' 1956-59; 4½ litre Limousine 1956.

M.G. 'Magnette' 1954.
Singer 'Hunter' 1955; 'Hunter S' 1956; 'Gazelle' 1959-60.

53625 538 Tail lamp. C.P.R., 3 1/8" dia.; 12v.; single contact; red lens; flush fitting; less cables and tubing

Citroen DS19 and ID19 1956-60.

53626 539 Flasher lamp. C.P.R., 3 1/8" dia.; 12v.; single contact; flush fitting; less cables and seating rubber.

Singer 'Gazelle' 1959-60.
Vauxhall 'Wyvern', 'Velox' and 'Cresta' 1956.
Wolseley 'Fifteen Sixty' 1960.

53630 532 Number plate illumination lamp. Domed glass cover on base plate; 12v.; single contact; 2" cable outside lamp; flange fixing.

Austin A55, A90, A95 and A105 (Vanden Plas) BS8 1958-59.
Commer ½ ton Forward Control Van and Passenger Chassis 1960.

Hillman 'Minx' De Luxe 1958-59.
Humber New 'Hawk' 1960; 'Super Snipe' and Estate Car 1959-60.

Morris 'Oxford', 'Traveller' and 'Hindustan' 1958-60.

Singer 'Gazelle' Estate Car 1958-59.
Standard 'Pennant' 1958-59; 'Companion' Van and Pick-up Truck and 'Ensign' 1958-60; 'Atlas' 10/12 cwt. Van and Pick-up Truck 1959-60.

53634 558 Stop tail lamp. C.P.R.; 12v.; one double contact and one single contact bulb holder; all red lens; oblong shape; flush fitting.

Austin 152 Range (Export North America) 1957-60; Half Ton Van and Pick-up Truck (Export U.S.A.) 1957-60; 'J2' Range (Export U.S.A.) 1957-60.

Rover '60', '90' and '105' (Export N.A.D.A.) 1957-58.

53639 570 Stop tail and flasher lamp. C.P.R., 7" dia.; 12v.; one double contact and one single contact bulb holder; red lens, with amber insert for flasher.

Lancia 'Appia' and 'Flamina' Coupés 1959-60.
Standard 'Vanguard' Saloon and 'Ensign' 1958.

53640 572 Stop tail and flasher lamp. C.P.R.; 12v.; one double contact and one single contact bulb holder; amber flasher lens and red stop tail lens; flush fitting.

Bentley 'Continental' Sports 1955-59.
Commer 'Cob' 1958-60; ½ ton Forward Control Van and Passenger Chassis 1960.
Hillman 'Husky' Series I 1958-60.

53643 587 Stop tail and flasher lamp. C.P. peaked rim; 12v.; one double contact and one single contact bulb holder; all red lens; flush fitting; as 53547 except for flasher lens.

Humber New 'Hawk' (Export U.S.A.) 1958-60; 'Super Snipe' (Export U.S.A.) 1959-60.

53660 558 Stop tail and flasher lamp. C.P.R.; 12v.; one double contact and one single contact bulb holder; all red lens, oblong shape; flush fitting; as 53556 except for lens.

Armstrong Siddeley 'Star Sapphire' and Limousine (Export U.S.A.) 1959-60.
Rover '60', '90' and '105' (Export N.A.D.A.) 1958-59; '80' and '100' (Export N.A.D.A.) 1960.

53663 596 Stop tail, flasher and reflex lamp. C.P.R.; 12v.; one double contact and one single contact bulb holder; amber lens at top, reflex in middle and stop tail lens at bottom; flush fitting; right hand lamp.

Riley 'One-Point-Five' 1958-60.

53664 596 Stop tail, flasher and reflex lamp. As 53663, but left hand lamp.

Riley 'One-Point-Five' 1958-60.

53665 596 Stop tail, flasher and reflex lamp. C.P.R.; 12v.; one double contact and one single contact bulb holder; all red lens, with reflex in the centre; flush fitting; right hand lamp.

Riley 'One-Point-Five' (Export U.S.A.) 1958-60.

53666 596 Stop tail, flasher and reflex lamp. As 53665, but left hand lamp.

Riley 'One-Point-Five' (Export U.S.A.) 1958-60.

53669 597 Stop tail and flasher lamp. C.P.R., oval shaped; 12v.; one double contact and one single contact bulb holder; flasher body and amber lens at top, stop tail and reflex body with red lens at bottom; flush fitting.

Riley 'Two-Point-Six' 1958-59.
Wolseley 'Six Ninety' 1957-59.

53670 597 Stop tail lamp. C.P.R., oval shaped; 12v.; two single contact bulb holders; tail lamp with red lens at top and stop lamp with red lens at bottom; flush fitting.

Riley 'Two-Point-Six' (when trafficators fitted) 1958-59.
Wolseley 'Six Ninety' (when trafficators fitted) 1957-59.

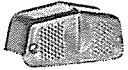

REAR LAMPS

VEHICLE APPLICATION REFERENCE—continued

- 53671 597 Stop tail and flasher lamp. C.P.R., oval shaped; 12v.; one double contact and one single contact bulb holder; flasher lamp with red lens at top and tail lamp with red lens at bottom; flush fitting.
Riley 'Two-Point-Six' (Export U.S.A.) 1958-59.
Wolseley 'Six Ninety' (Export U.S.A.) 1957-59.
- 53677 538 Stop flasher lamp. Red lens, 2 $\frac{3}{8}$ " dia.; 12v.; single contact; flush fitting; less rim.
Simca-Aronde De Luxe and 'Chatelaine' Station Wagon (Export U.S.A.) 1959.
- 53678 538 Tail lamp. Red lens, 2 $\frac{3}{8}$ " dia.; 12v.; single contact; flush fitting; less rim; as 53677 except for bulb.
Simca-Aronde De Luxe and 'Chatelaine' Station Wagon (Export U.S.A.) 1959.
- 53679 551 Stop flasher lamp. C.P.R.; 12v.; single contact; red lens, with reflex; flush fitting.
Simca-Vedette 'Beaulieu' and 'Chambord' 1959.
- 53685 572 Stop tail, flasher and reflex lamp. C.P.R.; 12v.; double contact; all red lens; flush fitting; special mounting gasket; two-screw fixing.
Commer 'Cob' Light Van (Export North America) 1958.
Hillman 'Husky' Series I (Export U.S.A.) 1958.
- 53686 538 Stop lamp. C.P.R., 3 $\frac{3}{8}$ " dia.; 12v.; single contact; red lens; flush fitting.
Citroen DS19 and ID19 1958-60.
Daimler 'Majestic' (Export U.S.A.) 1959-60.
Simca-Vedette 'Beaulieu' and 'Chambord' 1959.
- 53689 548 Stop tail, flasher and reflex lamp. C.P. body; 12v.; one double contact and one single contact bulb holder; red flasher lens at top, red stop tail lens at bottom and red reflex; flush fitting.
Alvis 3 litre Saloon and Coupé (Export Canada) 1959-60.
Aston Martin DB Mk. III (Export U.S.A.) 1958-59; DB4 and DB4GT (Export U.S.A.) 1959-60.
Peerless 'Gran Turismo' (Export U.S.A.) 1959-60.
- 53693 601 Stop tail and reflex lamp. Red, oblong lens, with clear inner lens and red reflex lower half of lens; 12v.; double contact; four-screw fixing.
Vauxhall 'Victor' (Export U.S.A.) 1958-60.
- 53694 600 Stop tail, flasher and reflex lamp. C.P.R., riveted to base; 12v.; one double contact and one single contact bulb holder; all red lens, with reflex in centre; flush fitting; as 53596 except for lens.
Standard 'Pennant' (Export N.A.D.A.) 1958-59.
- 53695 572 Stop tail, flasher, reverse and reflex lamp. C.P.R.; 12v.; one double contact and one single contact bulb holder; red stop tail and flasher lens, with lower half clear for reverse; flush fitting; two-screw fixing.
Sunbeam 'Rapier' (Export U.S.A.) 1958.
- 53702 606 Stop tail and reflex lamp. C.P.R., riveted to base plate; 12v.; double contact; red, oval shaped lens, with reflex; flush fitting.
Vauxhall 'Velox' and 'Cresta' 1958-59; 'Friary' Estate Car 1960.
- 53703 616 Stop tail, flasher and reflex lamp. Diecast base, incorporating C.P.R. and C.P. reflector; 12v.; one double contact and one single contact snap-in type bulb holder; amber and red lens keyed together; three-screw fixing.
Austin A40 1959-60.
- 53704 616 Stop tail, flasher and reflex lamp. As 53703 except for flasher lens, which is red.
Austin A40 1959-60.
- 53705 534 Number plate illumination lamp. C.P. cover; 12v.; single contact; domed, clear glass window; 40" cable; flush fitting.
Austin A40 1959-60; A90 and A95 'Countryman' 1958-59.
- 53710 570 Stop tail, flasher and reflex lamp. C.P.R., 7" dia.; 12v.; one double contact and one single contact bulb holder; red lens, with red insert for flasher; flush fitting.
Lancia 'Appia' and 'Flamina' Coupés (Export U.S.A.) 1959-60.
- 53711 620 Stop tail, flasher and reflex lamp. C.P.R., peaked at top, oval shaped; 12v.; one double contact and one single contact bulb holder; amber lens at top, reflex in centre and red lens at bottom; flush fitting.
Rover 3 litre 1959-60.
- 53712 621 Stop tail, flasher and reflex lamp. C.P. base, bullet shaped; 12" long \times 5 $\frac{1}{2}$ " across base; 12v.; one double contact and one single contact snap-in type bulb holder; amber flasher lens at top, red lens in centre, with rectangular reflex at bottom; three-stud fixing.
Austin A55 1959-60.
- 53713 621 Stop tail, flasher and reflex lamp. As 53712 except for flasher lens, which is red.
Austin A55 (Export North America) 1959-60.
- 53717 607 Rear flasher lamp. C.P. diecast body; 12v.; single contact; amber outer lens and clear inner lens; one-piece top motif; 20 $\frac{1}{2}$ " cable; three-stud fixing; right hand lamp.
Vauxhall 'Velox', 'Cresta' and 'Friary' Estate Car 1959-60.
- 53718 607 Rear flasher lamp. As 53717, but left hand lamp.
Vauxhall 'Velox', 'Cresta' and 'Friary' Estate Car 1959-60.
- 53719 623 Number plate illumination and reverse lamp. C.P. diecast base; overall length 24", with C.P. diecast cover 9 $\frac{1}{2}$ " long mounted on its centre; 12v.; three single contact bulb holders; clear lens, 7 $\frac{1}{2}$ " long; four-stud fixing.
Rover 3 litre 1959-60.
- 53726 627 Stop tail, flasher and reflex lamp. C.P. plinth; 12v.; one double contact and one single contact bulb holder; amber flasher lens at top, red stop tail lens in centre and 2 $\frac{1}{2}$ " dia. red reflex at bottom; left hand lamp.
Jaguar 2.4, 3.4 and 3.8 litre 1960.
- 53727 627 Stop tail, flasher and reflex lamp. As 53726, but right hand lamp.
Jaguar 2.4, 3.4 and 3.8 litre 1960.
- 53728 627 Stop tail, flasher and reflex lamp. C.P. plinth; 12v.; one double contact and one single contact bulb holder; amber flasher lens at top, red stop tail lens in centre and 2 $\frac{1}{2}$ " dia. red reflex at bottom; left hand lamp.
Jaguar Mk. IX 1960.
- 53729 627 Stop tail, flasher and reflex lamp. As 53728, but right hand lamp.
Jaguar Mk. IX 1960.
- 53738 627 Stop tail and flasher lamp. C.P. plinth; 12v.; one double contact and one single contact bulb holder; amber flasher lens at top, red stop tail lens in centre and 2 $\frac{1}{2}$ " dia. red reflex at bottom; left hand lamp.
Jaguar XK150 1960.
- 53739 627 Stop tail, flasher and reflex lamp. As 53738, but right hand lamp.
Jaguar XK150 1960.
- 53750 629 Stop tail, flasher and reflex lamp. C.P. base, bullet shaped, 16 $\frac{1}{2}$ " long \times 5 $\frac{1}{2}$ " across base; 12v.; one double contact and one single contact plug-in type bulb holder; amber flasher lens at top, red stop tail lens in centre, with reflex and reverse lens at bottom; flush fitting.
Morris 'Oxford' Saloon Series V 1959-60.
- 53751 629 Stop tail, flasher and reflex lamp. As 53750 except for flasher lens, which is red.
Morris 'Oxford' Saloon Series V (Export North America) 1959-60.
- 53752 572 Stop tail, flasher and reflex lamp. C.P. diecast hooded base; 12v.; one double contact and one single contact bulb holder; all red lens; flush fitting.
Commer 'Cob' Light Truck (Export North America) 1959.
Hillman 'Minx' 1959; 'Husky' Series I (Export U.S.A.) 1960.
- 53753 572 Stop tail, flasher and reflex lamp. As 53752 except for base, which is not hooded.
Commer 'Cob' Series II (Export U.S.A.) 1960.
Hillman 'Minx Special' (Export U.S.A.) 1959.
Singer 'Gazelle' (Export North America) (later) 1958-59.
Sunbeam 'Rapier' (later) 1958-60.
- 53754 572 Stop tail, flasher and reflex lamp. C.P. base; 12v.; one double contact and one single contact bulb holder; all red lens; flush fitting; as 53752 except for base and base seating gasket (Export North America).
Commer 'Cob' Light Van 1958-59; 3/4 ton Forward Control Van and Passenger Chassis 1960.
Hillman 'Husky' Series I (later) 1958-59.
- 53755 627 Stop tail, flasher and reflex lamp. C.P. plinth; 12v.; one double contact and one single contact bulb holder; red flasher lens at top, red stop tail lens in centre and 2 $\frac{1}{2}$ " dia. red reflex at bottom; as 53738 except for flasher lens; left hand lamp.
Jaguar XK150 1960.
- 53756 627 Stop tail, flasher and reflex lamp. As 53755, but right hand lamp.
Jaguar XK150 (Export U.S.A.) 1960.
- 53757 627 Stop tail, flasher and reflex lamp. C.P. plinth; 12v.; one double contact and one single contact bulb holder; red flasher lens at top, red stop tail lens in centre and 2 $\frac{1}{2}$ " dia. red reflex at bottom; as 53726 except for flasher lens; left hand lamp.
Jaguar 2.4, 3.4 and 3.8 litre (Export U.S.A.) 1960.
- 53758 627 Stop tail, flasher and reflex lamp. As 53757, but right hand lamp.
Jaguar 2.4, 3.4 and 3.8 litre (Export U.S.A.) 1960.
- 53759 627 Stop tail, flasher and reflex lamp. C.P. plinth; 12v.; one double contact and one single contact bulb holder; red flasher lens at top, red stop tail lens in centre and 2 $\frac{1}{2}$ " dia. red reflex at bottom; as 53728 except for flasher lens; left hand lamp.
Jaguar Mk. IX (Export U.S.A.) 1960.
- 53760 627 Stop tail, flasher and reflex lamp. As 53759, but right hand lamp.
Jaguar Mk. IX (Export U.S.A.) 1960.
- 53761 582 Tail and number plate illumination lamp. Black body; 12v.; single contact; red lens, 2 $\frac{3}{8}$ " dia.; centre spigot fixing.
A.C. Cars 'Petite' 1953-57; 16 Saloon (except Norway) 1948-52; Invalid Carriage 1947-51.
Barrett, W. & F. Invalid Carriage 1949-54.
Clecco Electrics 1952-55.
Commer 25 cwt. 'Lyons' Van 1949-50; 25 cwt. Forward Control 1946-48; 3 and 4 ton Tractor 1947-49.
Douglas 'Handy Van' 1949-50.
Leonard Gundle 'Handy Motor' 3-wheeler Delivery Van (later) 1952-55.
Jensen 6 ton 'JNSN' 1946-47; 30 cwt. 'Jen-Tug' 1946-54; Lightweight Commercial 1954.
Karrier 'Bantam' 1949-53.
Light Delivery Vehicles 'Tri-Van' 1949-51.
Morgan 3-wheeler 1948-52.
Morrison Electriccars 1 ton P90 1955-57.
Standard 12 (Export Belgium) 1946.
Trojan 15/20 cwt. Van and Truck (Petrol) 1946-53 and 1958; 15/20 cwt. Van and Truck (Diesel) 1958.
- 53762 631 Stop tail, flasher and reflex lamp. C.P.R., pear shaped; overall dimensions 9 $\frac{1}{2}$ " \times 4 $\frac{1}{2}$ "; 12v.; one double contact and one single contact bulb holder; amber flasher lens at top, red stop tail lens in centre, incorporating reflex at bottom; flush fitting.
Standard 'Vanguard' Saloon and 'Ensign' 1959-60.
- 53763 534 Number plate illumination lamp. C.P. cover; 12v.; single contact; domed, clear glass window; 10" cable; flush fitting.
Austin A55 1959-60.
M.G. 'Magnetite' Mk. III 1959-60.
Morris 'Oxford' Saloon Series V 1959-60.
Riley 'Four Sixty Eight' 1959-60.
Wolseley 'Fifteen Sixty' 1959-60.
- 53764 607 Rear flashing lamp. C.P. diecast body; 12v.; single contact; red outer lens and clear inner lens; one-piece top motif; 20 $\frac{1}{2}$ " cable; three-stud fixing; right hand lamp.
Vauxhall 'Cresta' and 'Friary' Estate Car (Export Canada) 1959-60.
- 53765 607 Rear flashing lamp. As 53764, but left hand lamp.
Vauxhall 'Cresta' and 'Friary' Estate Car (Export Canada) 1959-60.
- 53766 467 Number plate illumination lamp. Grey primer finish; overall dimensions 4 $\frac{3}{8}$ " \times 1 $\frac{1}{2}$ "; 12v.; single contact bulb holders; two-stud fixing.
Bedford CA Van (Export U.S.A.) 1959-60.

REAR LAMPS



VEHICLE APPLICATION REFERENCE—continued

- 53769 631 Stop tail, flasher and reflex lamp. C.P.R. pear shaped; overall dimensions $9\frac{1}{2}'' \times 4\frac{1}{4}''$; 12v.; one double contact and one single contact bulb holder; red flasher lens at top and red stop tail lens in centre, incorporating reflex at bottom; flush fitting.
Standard 'Vanguard' Saloon and 'Ensign' (Export N.A.D.A.) 1959-60.
- 53770 635 Stop tail, flasher, reflex and reverse lamp. C.P. diecast base; 12v.; two single contact and one double contact bulb holders; amber flasher lens at top, red stop tail lens and reflex in centre and white reverse lens at bottom; five staked fixing screws; flush fitting; left hand lamp.
Wolseley 'Fifteen Sixty' 1959-60.
- 53771 635 Stop tail, flasher, reflex and reverse lamp. As 53770 except for flasher lens, which is red; left hand lamp.
Wolseley 'Fifteen Sixty' (Export North America) 1959-60.
- 53772 636 Stop tail and flasher lamp. Amber lens at top, red lens at bottom, with clear lens fitted behind both and all cemented together with C.P. dividing clip covering joint; 12v.; one double contact and one single contact bulb holder; flush fitting.
Triumph 'Herald' 1959-60.
- 53773 637 Rear flasher lamp. Domed, amber lens, $3\frac{1}{8}''$ dia.; 12v.; single contact; flush fitting.
Reliant 'Regal' Car and 5 cwt. Van 1960.
Standard 'Atlas' 10/12 cwt. Forward Control Van and Pick-up Truck 1959-60.
- 53774 640 Stop tail and flasher lamp. C.P. base, incorporating two diecast reflectors; 12v.; one double contact and one single contact bulb holder; amber flasher lens at top and red stop tail lens at bottom, with aluminium shield between the two lenses; shaped to fit wing contour.
Austin A99 1959-60.
- 53775 640 Stop tail and flasher lamp. As 53774 except for flasher lens, which is red.
Austin A99 (Export North America) 1959-60.
- 53776 641 Stop tail, flasher and reflex lamp. C.P. triangular shaped base; $10''$ long \times $5''$ at base; 12v.; one double contact and one single contact bulb holder; amber flasher lens at top, red stop tail lens complete with rectangular shaped reflex at bottom; shaped to fit wing contour.
Austin B.M.C. 3 litre 'Princess' 1960.
Wolseley 'Six Ninety-Nine' 1959-60.
- 53777 641 Stop tail, flasher and reflex lamp. As 53776 except for flasher lens, which is red.
Austin B.M.C. 3 litre 'Princess' (Export U.S.A.) 1960.
Wolseley 'Six Ninety-Nine' (Export North America) 1959-60.
- 53779 642 Stop tail, flasher and reflex lamp. C.P.R., oval shaped; 12v.; one double contact and one single contact bulb holder; amber flasher lens at top and red stop tail lens with reflex at bottom; flush fitting.
Sunbeam 'Alpine' Sports 1959-60.
- 53783 581 Stop tail and reflex lamp. Red lens, with reflex, $3\frac{1}{8}''$ dia.; metal backplate with staked fixing screws; 12v.; double contact; $30''$ cable; flush fitting.
Rover 'Landrover' 1960.
- 53786 643 Number plate illumination lamp. 'L' shaped bracket, $5\frac{1}{2}''$ long; 12v.;
Triumph 'Herald' 1959-60.
- 53787 644 Reverse lamp. C.P. cover, $19\frac{1}{2}''$ long; 12v.; single contact; clear glass, $4\frac{1}{2}''$ wide; four-stud fixing.
M.G. 'Magnette' Mk. III 1959-60.
Riley 'Four Sixty-Eight' 1959-60.
- 53789 645 Reverse lamp. C.P. cover; overall dimensions $6\frac{1}{2}'' \times 2''$; 12v.; single contact; clear, dish shaped glass; two-screw fixing.
Austin B.M.C. 3 litre 'Princess' 1960.
Wolseley 'Six Ninety' 1959-60.
- 53790 635 Stop tail, flasher, reflex and reverse lamp. C.P. diecast base; 12v.; two single contact and one double contact bulb holders; amber flasher lens at top, stop tail lens and reflex in centre and white reverse lens at bottom; five staked fixing screws; flush fitting; right hand lamp.
Wolseley 'Fifteen Sixty' 1959-60.
- 53791 635 Stop tail, flasher, reflex and reverse lamp. As 53790 except for flasher lens, which is red.
Wolseley 'Fifteen Sixty' (Export North America) 1959-60.
- 53792 646 Stop tail and flasher lamp. Diecast base, with C.P.R.; 12v.; one double contact and one single contact bulb holder; domed, amber flasher lens and red stop tail lens; shaped to fit wing contour; three-screw fixing; left hand lamp.
M.G. 'Magnette' Mk. III 1959-60.
Riley 'Four Sixty-Eight' 1959-60.
- 53793 646 Stop tail and flasher lamp. As 53792 except for flasher lens, which is red.
M.G. 'Magnette' Mk. III 1959-60.
Riley 'Four Sixty-Eight' 1959-60.
- 53794 646 Stop tail and flasher lamp. As 53792 except for flasher lens, which is red.
M.G. 'Magnette' Mk. III (North America) 1959-60.
Riley 'Four Sixty-Eight' (Export North America) 1959-60.
- 53795 646 Stop tail and flasher lamp. As 53792 except for flasher lens, which is red, and base; right hand lamp.
M.G. 'Magnette' Mk. III (Export North America) 1959-60.
Riley 'Four Sixty-Eight' (Export North America) 1959-60.
- 53797 647 Stop tail, flasher and reflex lamp. Oval shaped, diecast base; 12v.; one double contact and one single contact bulb holder; amber flasher lens at top and red stop tail lens, incorporating reflex, at bottom; three-screw fixing; left hand lamp.
Austin 'Seven' (850) 1959-60.
Morris 'Mini-minor' (850) and $\frac{1}{4}$ ton 'Mini-van' 1959-60.
- 53798 647 Stop tail, flasher and reflex lamp. As 53797, but right hand lamp.
Austin 'Seven' (850) 1959-60.
Morris 'Mini-minor' (850) and $\frac{1}{4}$ ton 'Mini-van' 1959-60.
- 53799 647 Stop tail, flasher and reflex lamp. As 53797 except for flasher lens, which is red.
Austin 'Seven' (850) (Export North America) 1959-60.
Morris 'Mini-minor' (850) (Export North America) 1959-60.
- 53800 647 Stop tail, flasher and reflex lamp. As 53798 except for flasher lens, which is red.
Austin 'Seven' (850) (Export North America) 1959-60.
Morris 'Mini-minor' (850) (Export North America) 1959-60.
- 53801 642 Stop tail, flasher and reflex lamp. As 53799 except for flasher lens, which is red.
Sunbeam 'Alpine' Sports (Export U.S.A.) 1959-60.
- 53806 637 Rear flasher lamp. Domed, amber lens, $3\frac{1}{8}''$ dia.; 12v.; single contact; flush fitting.
Rover 'Landrover' 1960.
- 53814 649 Number plate illumination lamp. C.P. cover; 12v.; two single contact bulb holders, mounted on base plate; clear, dished shaped glass.
Austin A55 (later) 1960; A99 and B.M.C. 3 litre 'Princess' 1960.
M.G. 'Magnette' Mk. III (later) 1960.
Morris 'Oxford' Saloon Series V (later) 1960.
Riley 'Four Sixty-Eight' and 'Six Ninety-Nine' (later) 1960.
- 53815 620 Stop tail, flasher and reflex lamp. As 53711 except for flasher lens, which is red.
Rover 3 litre (Export N.A.D.A.) 1959-60.
- 53816 636 Stop tail and flasher lamp. As 53772 except for flasher lens, which is red.
Triumph 'Herald' 1959-60.
- 53818 538 Stop tail lamp. Red lens, $2\frac{3}{8}''$ dia.; 12v.; double contact; flush fitting; less rim.
Daimler SP250 1960.
- 53819 551 Stop tail and reflex lamp. C.P.R., $3\frac{3}{8}''$ dia.; 12v.; double contact; red lens, with reflex; $21''$ cable; flush fitting.
Lotus 'Elite' 1959-60.
- 53822 534 Number plate illumination lamp. C.P. cover; 12v.; single contact; domed, clear glass window; $54''$ cable; flush fitting.
Austin A99 1959-60.
- 53823 654 Stop tail, flasher and reflex lamp. C.P.R., oval shaped; 12v.; one double contact and one single contact bulb holder; amber flasher lens at top and red stop tail lens, incorporating sealed reflex, at bottom; two-screw fixing; flush fitting.
Hillman 'Minx' De Luxe 1959-60.
- 53824 654 Stop tail, flasher and reflex lamp. As 53823 except for flasher lens, which is red.
Hillman 'Minx' De Luxe (Export U.S.A.) 1959-60.
- 53826 532 Number plate illumination lamp. Domed glass cover on back plate; 12v.; single contact; $15''$ cable outside lamp; flange fixing.
Bentley 'Continental' 1960.
- 53836 467 Number plate illumination lamp. C.P. finish; overall dimensions $4\frac{1}{8}'' \times 1\frac{1}{2}''$; 12v.; two single contact bulb holders; clear lens; two-stud fixing.
Austin-Healey 'Sprite' (Export Switzerland) 1960.
M.G. MGA 1960.
Morris 'Minor 1000' (Export Denmark) 1960; 'Mini-minor' (850) De Luxe and $\frac{1}{4}$ ton 'Mini-van' (later) 1960.
Triumph 'Herald' (Export N.A.D.A.) 1960.
- 53837 467 Number plate illumination lamp. Black finish; overall dimensions $4\frac{1}{8}'' \times 1\frac{1}{2}''$; 12v.; two single contact bulb holders; clear lens; two-stud fixing.
Morris 'Traveller' (Export Denmark) 1960; 'Mini-minor' (850) and $\frac{1}{4}$ ton 'Mini-van' (later) 1960.
- 53838 549 Stop tail and reflex lamp. C.P.R.; 12v.; double contact; red lens, incorporating reflex; two-screw fixing; left hand lamp.
Austin Taxi and Hire Car 1959-60.
- 53839 549 Stop tail and reflex lamp. As 53838, but right hand lamp.
Austin Taxi and Hire Car 1959-60.
- 53842 539 Rear flasher lamp. C.P.R., $3\frac{3}{8}''$ dia.; 12v.; single contact; red lens; flush fitting.
Singer 'Gazelle' (Export U.S.A.) 1959-60.
- 53875 551 Stop tail and reflex lamp. C.P.R., $3\frac{3}{8}''$ dia. 12v.; double contact; red lens, incorporating reflex; flush fitting.
Bentley 'Continental' 1960.
- 53876 467-2 Number plate illumination lamp. Black finish; overall dimensions $4\frac{1}{8}'' \times 1\frac{1}{2}''$; 12v.; single contact; double cable entry hole; clear lens; two-stud fixing.
Rover 'Landrover' 1960.
- 53902 594 Tail lamp. C.P.R., $2\frac{3}{8}''$ dia.; 12v.; single contact bulb holder; red lens; flexible body; flush fitting.
Citroen 'Safari' 1960.
- 058619 551/539 Stop tail and flasher lamp. Incorporating 551 and 539 units, with C.P. sunken rims; 12v.; one double contact and one single contact bulb holder; amber flasher lens and red stop tail lens; flush fitting.
Austin A40 and A90 1956; A50 1956-57.
- 058647 551/538 Stop tail and flasher lamp. As 058619 except for flasher lens, which is red.
Austin A50 (Export U.S.A. and Canada) 1957.
- 058721 494 Reverse lamp. C.P. finish; 12v.; single contact; clear lens; complete with switch and cable; spigot fixing (optional).
Austin A55 1960.
- 575923 574 Number plate illumination and reverse lamp. C.P.R., $2\frac{3}{8}''$ dia.; 12v.; two single contact bulb holders; domed, clear number plate lens and clear circular reverse lens; less body and body gasket.
Humber New 'Hawk' 1958-60; New 'Super Snipe' 1959-60.

